

Frequency transmitter Ex i field circuit

Series 9146



Contents

1	General Information	3
1.1	Manufacturer	3
1.2	Information about this Manual.....	3
1.3	Further Documents	3
1.4	Conformity with Standards and Regulations.....	3
2	Explanation of Symbols	4
2.1	Symbols used in this Manual	4
2.2	Warning Notes	4
2.3	Symbols on the Device	5
3	Safety Notes	5
3.1	Storage of the Manual.....	5
3.2	Personnel Qualification	5
3.3	Safe Use	6
3.4	Modifications and Alterations	7
4	Function and Device Design	7
4.1	Function	7
4.2	Device Design.....	8
5	Technical Data	9
6	Project Engineering.....	12
7	Transport and Storage	12
8	Mounting and Installation	13
8.1	Dimensions/Fastening Dimensions.....	13
8.2	Mounting/Dismounting, Operating Position.....	14
8.3	Installation.....	16
9	Parameterisation and Commissioning	18
9.1	Replacing the Device	18
9.2	Parameterisation.....	19
10	Operation	22
10.1	Operation	22
10.2	Indicators	22
10.3	Troubleshooting	23
11	Maintenance, Overhaul, Repair	24
11.1	Maintenance	24
11.2	Maintenance	24
11.3	Repair	24
11.4	Returning the Device	25
12	Cleaning.....	25
13	Disposal	25
14	Accessories and Spare Parts.....	25

1 General Information

1.1 Manufacturer

R. STAHL Schaltgeräte GmbH
Am Bahnhof 30
74638 Waldenburg
Germany

Tel.: +49 7942 943-0
Fax: +49 7942 943-4333
Internet: r-stahl.com
E-mail: info@r-stahl.com

1.2 Information about this Manual

ID no.:	914660330020
Publication code:	2023-07-17-HB00-III-en-01
Hardware version:	A/1
Software version:	01-01

The original manual is the English edition.
This is legally binding in all legal affairs.

1.3 Further Documents

- Cabinet installation guide
- Data sheet
- Operating instructions
- National information and documents relating to use in hazardous areas (see also chapter 1.4)

For documents in other languages, see r-stahl.com.

1.4 Conformity with Standards and Regulations

IECEX, ATEX, EU Declaration of Conformity and further national certificates and documents can be downloaded via the following link:

<https://r-stahl.com/en/global/support/downloads/>

Depending on the scope of validity, additional Ex-relevant information may be attached.

IECEX is also available at: <https://www.iecex.com/>

2 Explanation of Symbols

2.1 Symbols used in this Manual

Symbol	Meaning
	Tips and recommendations on the use of the device
	Danger due to explosive atmosphere





2.2 Warning Notes

Warning notes must be observed under all circumstances, in order to minimise the risk resulting from design engineering and operation. The warning notes have the following structure:

- Signalling word: DANGER, WARNING, CAUTION, NOTICE
- Type and source of danger/damage
- Consequences of danger
- Taking countermeasures to avoid the danger or damage

	DANGER
	Danger to persons Non-compliance with the instruction results in severe or fatal injuries to persons.
	WARNING
	Danger to persons Non-compliance with the instruction can result in severe or fatal injuries to persons.
	CAUTION
	Danger to persons Non-compliance with the instruction can result in light injuries to persons.
NOTICE	
Avoiding material damage Non-compliance with these instructions can result in material damage to the device and/or its surroundings.	

2.3 Symbols on the Device

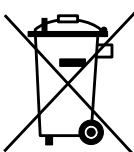
Symbol	Meaning
 0158 05594E00	CE marking according to the current applicable directive.
 02198E00	Electrical circuit certified for hazardous areas according to the marking.
 15649E00	Input
 15648E00	output
 11048E00	Safety notes that must always be observed: For devices with this symbol, the corresponding data and/or the safety-relevant notes contained in this manual must be observed.
 20690E00	Marking according to WEEE Directive 2012/19/EU

3 Safety Notes

3.1 Storage of the Manual

- Read the manual carefully.
- Store the manual at the mounting location of the device.
- Observe applicable documents and operating instructions of the devices to be connected.

3.2 Personnel Qualification

Qualified specialist personnel are required to perform the activities described in this manual. This primarily applies to work in the following areas

- Project engineering
- Mounting/dismounting the device
- (Electrical) installation
- Commissioning
- Maintenance, repair, cleaning

Specialists who perform these activities must have a level of knowledge that meets applicable national standards and regulations.

Additional knowledge is required for any activity in hazardous areas!

R. STAHL recommends having a level of knowledge equal to that described in the following standards:

- IEC/EN 60079-14 (Electrical installations design, selection and erection)
- IEC/EN 60079-17 (Electrical installations inspection and maintenance)
- IEC/EN 60079-19 (Equipment repair, overhaul and reclamation)

3.3 Safe Use

Before mounting

- Read and observe the safety notes in this manual.
- Ensure that the contents of this manual are fully understood by the personnel in charge.
- Use the device in accordance with its intended and approved purpose only.
- Always consult R. STAHL Schaltgeräte GmbH if using the device under operating conditions which are not covered by the technical data.
- Make sure that the device is not damaged.
- We are not liable for damage caused by incorrect or unauthorised use of the device or by non-compliance with this manual.



For mounting and installation

- Have mounting and installation performed only by qualified and authorised persons (see chapter "Personnel qualification").
- The device is only to be installed in areas for which it is suited based on its marking.
- During installation and operation, observe the information (characteristic values and rated operating conditions) on the rating, data and information plates located on the device.
- Before installation, make sure that the device is not damaged.
- Install the device in Zone 2 or outside of hazardous areas.
- When used in Zone 2, the device must be installed in a protective enclosure or in a cabinet according to IEC/EN 60079-0. This enclosure (or cabinet) must have a suitable degree of protection (at least IP54).
- Only operate the device in environments corresponding to degree of pollution 2 or lower according to IEC/EN 60664-1.
- Intrinsically safe devices of Zones 1, 0, 21 and 20 can be connected to the intrinsically safe signal circuits, even when used in Zone 2.
- Electrical circuits with the "Ex i" type of protection may no longer be operated as electrical circuits with this type of protection after being operated with electrical circuits with other types of protection.

Commissioning, maintenance, repair

- Only have commissioning and repairs performed by qualified and authorised persons (see chapter "Personnel qualification").
- Before commissioning, make sure that the device is not damaged.
- Only perform maintenance work described in this manual.
- Repair work on the devices must be performed only by R. STAHL Schaltgeräte GmbH.

3.4 Modifications and Alterations

	<p style="text-align: center;">DANGER</p> <p>Explosion hazard due to modifications and alterations to the device! Non-compliance results in severe or fatal injuries.</p> <ul style="list-style-type: none"> • Do not modify or change the device.
	<p>No liability or warranty for damage resulting from modifications and alterations.</p>

4 Function and Device Design

	<p style="text-align: center;">DANGER</p> <p>Explosion hazard due to improper use! Non-compliance results in severe or fatal injuries.</p> <ul style="list-style-type: none"> • Use the device only according to the operating conditions described in this manual. • Use the device only for the intended purpose specified in this manual.
---	---

4.1 Function

Application range

The frequency transmitter is used for monitoring the r.p.m. of rotating machines or system sections in hazardous areas. The connected sensor or contact can be installed in Zones 0 and 1 or Div 1 and 2. The device is permitted for use in Zone 2 and outside of hazardous areas.

Mode of operation

The frequency transmitter converts intrinsically safe binary input signals into analogue signals proportional to the frequency (non-intrinsically safe). Initiators according to IEC/EN 60947-5-6 (NAMUR) or potential-free contacts/optocoupler outputs with suitable resistance wiring can be used as signal transducers. The 9146/10-11-12 variant additionally provides limiting value output and pulse forwarding functions.

4.2 Device Design

Type 9146/10-11-12, 1-channel

	#	Device element	Description
	1	Black/green terminals	Connection terminals for the safe area
	2	"PWR" LED, green	Auxiliary power indicator
	3	Red "LF1" LED	Indication of line fault detection
	5	DIP switch "LF1"	Activation of line fault detection
	6	DIP switch "ADJ1"	Manual resetting of the counter function
	9	Blue terminals	Connection terminals for the hazardous area (intrinsically safe Ex i)
	10	Parameterisation interface	Configuration of the device using "ISpac Wizard" software type 9199
	11	"A"/"B" LED, yellow	Indicator for limit contacts
	9		
	10		
	11		

Type 9146/20-11-11, 2-channel

	#	Device element	Description
	1	Black terminals	Connection terminals for the safe area
	2	"PWR" LED, green	Auxiliary power indicator
	3	Red "LF1" LED	Indication of line fault detection for channel 1
	4	Red "LF2" LED	Indication of line fault detection for channel 2
	5	DIP switch "LF1"	Activation of line fault detection for channel 1
	6	DIP switch "ADJ1"	Manual resetting of the counter function for channel 1
	7	DIP switch "LF2"	Activation of line fault detection for channel 2
	8	DIP switch "ADJ2"	Manual resetting of the counter function for channel 2
	9	Blue terminals	Connection terminals for the hazardous area (intrinsically safe Ex i)
	10	Parameterisation interface	Configuration of the device using "ISpac Wizard" software type 9199

5 Technical Data

Marking

Type designation 9146/.0-11-1.

CE marking ₀₁₅₈

Explosion protection

Global (IECEX)

Gas, dust and mining	IECEX BVS 13.0095X Ex ec nC [ia Ga] IIC T4 Gc [Ex ia Da] IIIC [Ex ia Ma] I
----------------------	---

Europe (ATEX)

Gas, dust and mining	BVS 05 ATEX E 171 X Ⓢ II 3 (1) G Ex ec nC [ia Ga] IIC T4 Gc Ⓢ II (1) D [Ex ia Da] IIIC Ⓢ I (M1) [Ex ia Ma] I
----------------------	---

Certifications and certificates

Certifications	IECEX, ATEX, EAC, Canada (cFM), USA (FM)
Ship certificates	DNV (EU RO Mutual Recognition), CCS

Safety data

Max. voltage U_o	10.5 V
Max. current I_o	23.4 mA
Max. power P_o	61.4 mW
Max. connectable capacitance C_o	
IIC	2.41 μ F
IIB/IIIC	16.8 μ F
IIA	75 μ F
I	95 μ F
Max. connectable inductance L_o	
IIC	63 mH
IIB/IIIC	230 mH
IIA	450 mH
I	600 mH
Internal capacitance C_i	negligible
Internal inductance L_i	negligible
Safety-related maximum voltage	253 V

Technical data

Electrical data

Auxiliary power	
Nominal voltage U_N	24 V DC
Voltage range	18 to 31.2 V
Residual ripple within the voltage range	$\leq 3.6 V_{SS}$
Nominal current at U_N	
1 channel	55 mA
2 channels	75 mA
Power consumption at U_N	
1 channel	1.32 W
2 channels	1.8 W
Polarity reversal protection	yes
Ex i input	
Input signal	according to IEC/EN 60947-5-6 (NAMUR)
Current for ON/OFF	
ON	2.1 mA
OFF	1.2 mA
Hysteresis	0.2 mA
Open-circuit voltage	8.5 V
Short-circuit current	≤ 8.5 mA
Input frequency	0.001 to 20,000 Hz
Pulse length/pause	25 μ s
Accuracy	< 0.1% of measuring range
Output	
Output signal (configurable)	0/4 to 20 mA
Function range	0 to 20.5 mA
Connectable load resistance	0 to 600 Ω
Operating modes	Counter, period measurement, variable gate time

Technical data

Pulse output			
Frequency range	0 to 5 kHz		
Input/output splitting ratio	1:1 to 1:20,000		
Switching voltage	$\leq \pm 30 \text{ V}$		
Switching current	$\leq 50 \text{ mA}$		
Parameterisation	with ISpac Wizard software		
	If the "Pulse output" function is activated, the forwarding of a pulsed signal at the input is activated at output "B" (see connection diagram)		
Electromagnetic compatibility			
	Tested in accordance with the following standards and regulations: IEC/EN 61326-1 Use in industrial environments; NAMUR NE 21		
Ambient conditions			
Ambient temperature			
Single device	-40 to +70 °C		
Group assembly	-40 to +60 °C		
	Installation conditions influence the ambient temperature. Please observe the "Cabinet installation guide"		
Storage temperature	-40 to +80 °C		
Relative humidity (no condensation)	$\leq 95\%$		
Use at height	< 2000 m		
Mechanical data			
Connection		Screw terminals	Spring clamp terminals
	Single-wire connection		
- rigid		0.2 to 2.5 mm ²	0.2 to 2.5 mm ²
- flexible		0.2 to 2.5 mm ²	0.2 to 2.5 mm ²
- flexible with core end sleeves (without/with plastic sleeve)		0.25 to 2.5 mm ²	0.25 to 2.5 mm ²
	Two-core connection		
- rigid		0.2 to 1 mm ²	–
- flexible		0.2 to 1.5 mm ²	–
- flexible with core end sleeves		0.25 to 1 mm ²	0.5 to 1 mm ²

For further technical data, see r-stahl.com.

6 Project Engineering

NOTICE

An ambient temperature that is too high may cause failure of the devices installed in the cabinet.

Non-compliance can result in material damage.

- Install and set up the cabinet in such a way that all devices installed within it are always operated within their permissible temperature range (see cabinet installation guide).



You can find detailed information about project engineering in the "Cabinet installation guide" (download at r-stahl.com, product documentation, sub-item "Project engineering").

7 Transport and Storage

- Transport and store the device only in the original packaging.
- Store the device in a dry place (no condensation) free of vibrations.
- Do not drop the device.

8 Mounting and Installation

The device is approved for use in gas hazardous areas of Zone 2 and in safe areas.

	DANGER
	<p>Explosion hazard due to incorrect installation of the device! Non-compliance results in severe or fatal injuries.</p> <ul style="list-style-type: none"> • Carry out installation strictly according to the instructions and national safety and accident prevention regulations to maintain explosion protection. • Select and install the electrical device so that explosion protection is not affected due to external influences, i.e. pressure conditions, chemical, mechanical, thermal and electrical influences such as vibration, humidity and corrosion (see IEC/EN 60079-14). • The device must only be installed by trained qualified personnel who are familiar with the relevant standards.

8.1 Dimensions/Fastening Dimensions

Dimensional drawings (all dimensions in mm [inch]) – Subject to change

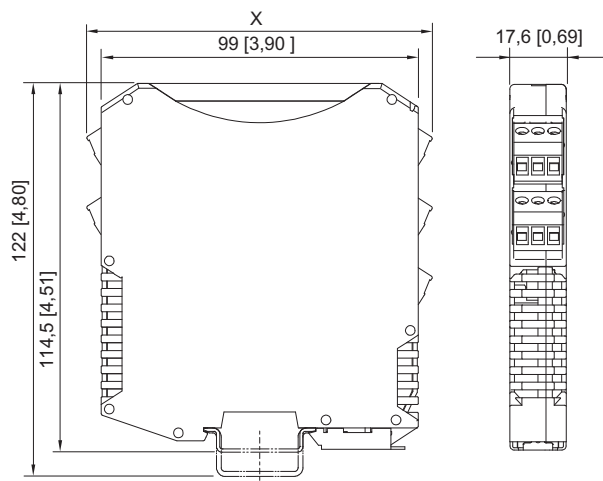

	Dimension X
Screw terminals	108 [4.25]
Spring clamp terminals	128 [5.04]

09685E00

8.2 Mounting/Dismounting, Operating Position

8.2.1 Mounting/Dismounting the pac-Bus

The pac-Bus is an accessory which makes it easier to wire the auxiliary power and read out the collective error message.

i	The components for the pac-Bus type 9194 must be ordered separately.
----------	--

Mounting

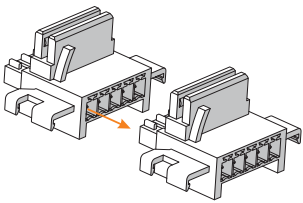
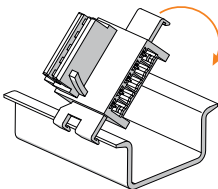
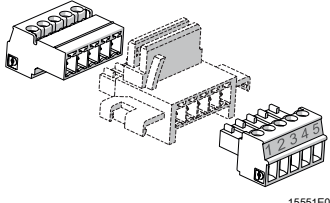
 <p style="text-align: right; font-size: small;">07392E00</p>	<ul style="list-style-type: none"> • Connect the required number of pac-Bus elements.
 <p style="text-align: right; font-size: small;">07391E00</p>	<ul style="list-style-type: none"> • Engage the pac-Bus elements on the DIN rail.
 <p style="text-align: right; font-size: small;">15551E00</p>	<ul style="list-style-type: none"> • Connect the terminal set at the beginning and at the end.

Dismounting

- Perform the mounting steps in reverse order.

8.2.2 Mounting/Dismounting the Device on the DIN Rail and pac-Bus

Mounting on DIN rail

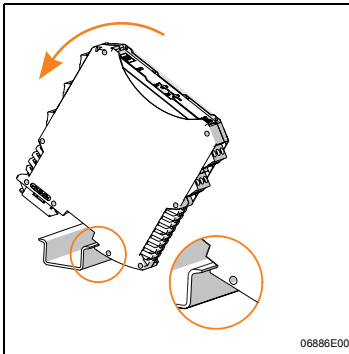

- Position the device on the DIN rail. When doing so, position the cut-out in the enclosure on the outside edge of the DIN rail.
- Engage the device on the DIN rail.
- When swivelling the device onto the DIN rail, make sure that it is not set at an angle.

Mounting on pac-Bus

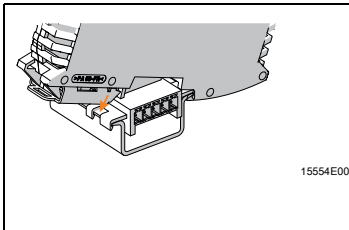

The pac-Bus is equipped with a polarisation guide and the device is equipped with a matching polarisation slot.

- Position the device as shown in the image. When doing so, position the cut-out in the enclosure on the outside edge of the DIN rail.
- Engage the device on the pac-Bus.

Dismounting

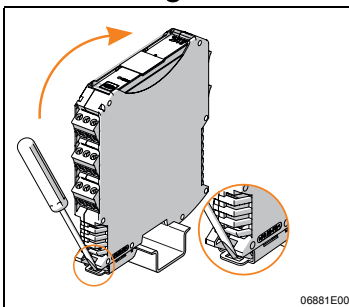

- Pull out the base bolt slightly using a screwdriver.
- Swivel out the device.

8.2.3 Mounting/Dismounting pluggable Terminals

Mounting

- Insert the terminal into the device until the terminal engages.

Dismounting

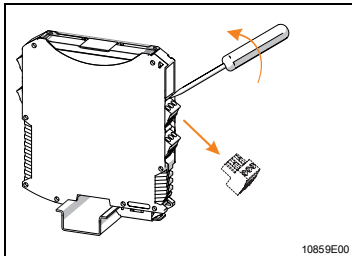

- Position the screwdriver behind the terminal.
- Push out the terminal.

8.3 Installation



Operation under difficult conditions, e.g. on ships in particular, requires additional measures to be taken for correct installation, depending on the operating location. Further information and instructions on this can be obtained on request from your designated sales contact.

8.3.1 Schematic Diagrams

Type 9146/10-11-12 1 channel, with limit contacts

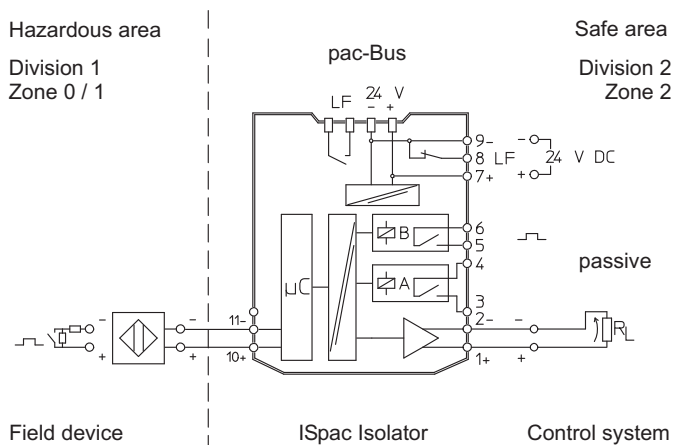

11019E00

Type 9146/20-11-11 2 channels

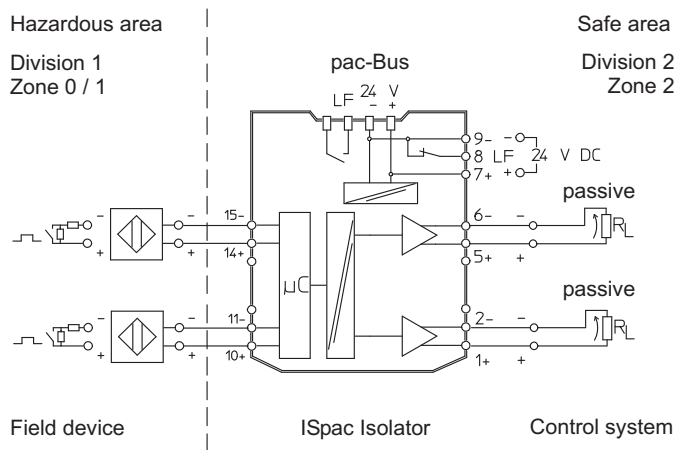

11020E00

8.3.2 Connection of Contacts

Circuitry for line fault detection if the contacts at the input are de-energised:

Schematic

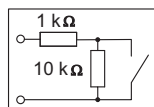

15529E

Short-circuit detection: 1 k Ω in series
Open-circuit detection: 10 k Ω parallel

i	Create the circuitry for line fault detection in the immediate vicinity of the contact.
----------	---

8.3.3 Connection of Power Supply

Type of supply	Connection
Direct supply to the device via 24 V connection	Green terminal "7+" and "9-"
Supply via pac-Bus	pac-Bus terminal "1+" and "2-"

9 Parameterisation and Commissioning

	DANGER
	<p>Explosion hazard due to incorrect installation! Non-compliance results in severe or fatal injuries.</p> <ul style="list-style-type: none"> • Check the device for proper installation before commissioning. • Comply with national regulations.

Before commissioning, ensure the following:

- The device is installed according to regulations.
- The electrical lines are connected correctly.
- The device and connection lines show no signs of damage.
- The screws are securely fastened to the terminals.
 Correct tightening torque: 0.5 to 0.6 Nm.

9.1 Replacing the Device

- If replacing this with a device that has an identical design, readjust the DIP switch and parameterise it using ISpac Wizard, if necessary.

9.2 Parameterisation

9.2.1 DIP Switches "LF" and "ADJ"

There is a 4-pole DIP switch at the front of the frequency transmitter.

	Line fault detection DIP switch "LF"		Resetting the counter function of DIP switch "ADJ" **)
	deactivated *)	activated	OFF-OFF-OFF or ON-OFF-ON
Channel 1			
Channel 2			

*) Default setting upon delivery, **) see following chapter "Input"

The DIP switches "LF1" and "LF2" are used to activate the line fault detection (see table above) and to reset the reclosing lockout (see the "Reclosing lockout" chapter), respectively.

The DIP switches "ADJ1" and "ADJ2" allow the minimum and maximum counts of the pulse counters for channel 1 and channel 2, respectively, to be reset.

Line faults and auxiliary power failure are signalled via LED, fault message contact on the module and collective error message via pac-Bus (see chapter "Schematic circuit diagrams of up to 2-channel designs").

i	Changing the DIP switch settings is permitted, even during operation in Zone 2 and with intrinsically safe input signals connected.
----------	---

i	The characteristics of the output signal are set using the "ISpac Wizard" software. It also allows the line fault detection to be completely deactivated. This setting determines the characteristics of the device, while the DIP switch is completely ineffective in this case.
----------	---

9.2.2 Input (via "ISpac Wizard" Software)

The frequency transmitter offers different operating modes, which can be set depending on the application. The default setting is the "Frequency via period measurement" operating mode.

Selection	Description
Counter (0 to 65535)	Incoming pulses are counted. The analogue output signal (0/4 to 20 mA) is increased linearly until the counter value is reached. The maximum counter value can be set.
Counter overflow	If the overflow is activated, the counter will start counting again when the maximum counter value is exceeded, and the output signal (sawtooth) will follow. When the overflow is off, the counter and the analogue signal will stop when the maximum value is reached. They can be reset via the DIP switches "ADJ1" and "ADJ2" at the front (OFF-ON-OFF and ON-OFF-ON, respectively)
Frequency via period measurement	For measurements in the range from 1 mHz to 1 kHz
Frequency via events (50, 200 or 1000 ms)	For measurements in the range from 1 to 20 kHz

9.2.3 Signal Processing (via "ISpac Wizard" Software)

The selection allows the frequency range to be restricted for further processing inside the module. The minimum value of the analogue output corresponds to the set minimum frequency and the same is true of the maximum values.

This allows the user to define the frequency range relevant for them and set it in relation to the range of the output signal (0 to 20 mA or 4 to 20 mA).

9.2.4 Output (via "ISpac Wizard" Software)

The characteristics of the analogue and pulse outputs can be configured here.

Analogue output:

Apart from selecting whether the analogue signal should adopt values between 0 to 20 mA or 4 to 20 mA, the characteristics of the output in the case of an error can be defined. The selections include "Output error value" (freely selectable), "Keep last value" or "Error detection off".

Pulse output:

The pulse output (relay output B) can be activated and deactivated. In addition, a splitter ratio of between 1 and 20,000 can be entered.

9.2.5 Limiting Value Setting (via "ISpac Wizard" Software)

The trip amplifier function is configured using the "ISpac Wizard" software. The following diagram shows possible adjustments of the limit contacts for relays A and B. This is an example; other assignments are possible.

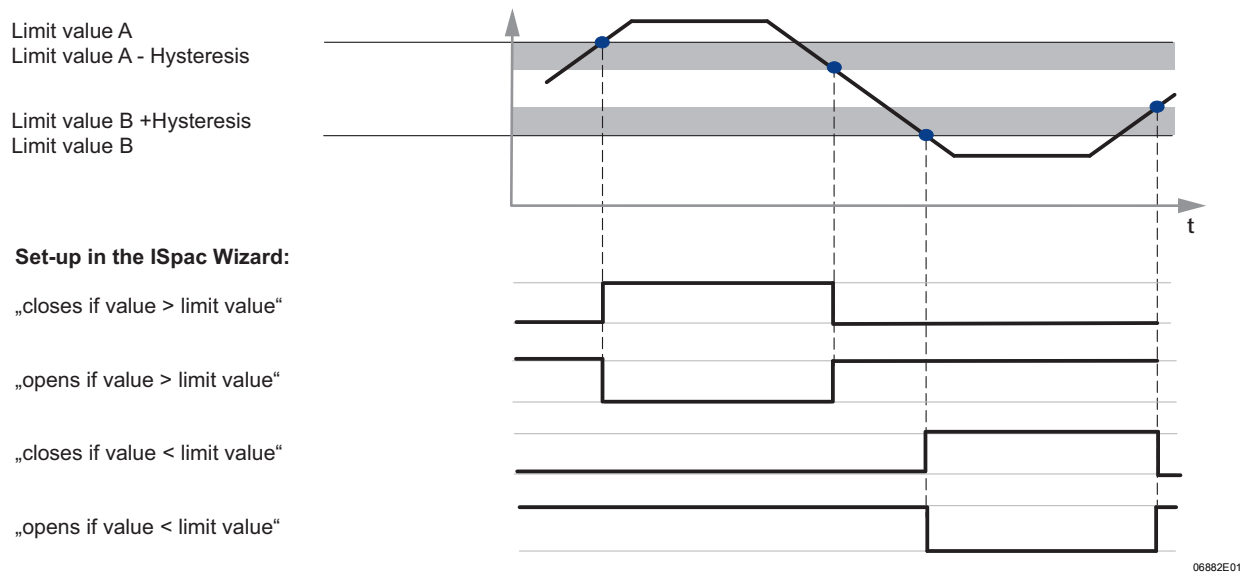

If a line fault is detected, the limit value relays adopt the set operating direction, for example, in the case of "Off above limiting value", the relays drop out. This is the recommended setting for safety-related circuits.

9.2.6 Reclosing Lockout (via "ISpac Wizard" Software)

The reclosing lockout is configured using the "ISpac Wizard" software. The reclosing lockout ensures that, if a limiting value is reached, the limit contact remains in the work position even if the process variable that caused the response is no longer valid. This function is used to ensure that personnel are made aware if the level exceeds or falls below the limiting values.

Selection	Description
"Deactivated"	Default setting – function is off
"Activated"	Function as described above. When the event occurs, the set operating mode ("On" or "Off") does not change. The reclosing lockout remains active even if the power supply is interrupted. The reclosing lockout is only reset if the DIP switch "LF1" or "LF2" (OFF-ON-OFF or ON-OFF-ON) at the front is pressed. If an error occurs at the same time, the limit value relays switch to alarm state (e.g.: On above limiting value -> in case of error: ON).

9.2.7 Start Override

The start override ensures that the limiting value settings "On below limiting value" or "Off below limiting value" do not activate the limit contact even if the level at the input has fallen below the limiting value. This function allows a machine or system to start up without an alarm message being output.

When the start override is active, the first edge at the input ensures the start of the function. Reactivation is made possible by briefly interrupting the power supply.

10 Operation

10.1 Operation

Possible adjustments during operation

i	Changing the settings for the various operating modes or the line fault detection via the "ISpac Wizard" software or the DIP switches is permitted during operation, even in Zone 2 and with intrinsically safe input signals connected.
----------	--

For a more detailed description of the function of the DIP switches and the possible adjustments using the "ISpac Wizard" software, refer to the "Parameterisation and commissioning" chapter.

10.2 Indicators

The corresponding LEDs on the device indicate the operating state of the device (see also the "Function and device design" chapter).

LED	Colour	"ON" LED	"OFF" LED
"PWR" LED	green	Device is supplied with auxiliary power	Device is not in operation, power supply not available
"LF1" LED	red	Line fault in signal of channel 1	No line fault in signal of channel 1
"LF2" LED	red	Line fault in signal of channel 2	No line fault in signal of channel 2
"A" LED	yellow	Level exceeds or falls below limiting value A. Limit contact has switched.	Level does not exceed or fall below limiting value A. Limit contact is in the idle position.
"B" LED	yellow	Level exceeds or falls below limiting value B. Limit contact has switched.	Level does not exceed or fall below limiting value B. Limit contact is in the idle position.

10.3 Troubleshooting

For troubleshooting, refer to the following troubleshooting guide:

Error	Cause of error	Troubleshooting
"PWR" LED (green) is off	<ul style="list-style-type: none"> Auxiliary power failure Defective miniature fuse Polarity reversal of the auxiliary power supply 	<ul style="list-style-type: none"> Check the polarity of the auxiliary power supply. Check the wiring of the auxiliary power supply. If the fuse is defective, have the device repaired.
"PWR" LED (green) blinks constantly	Defective device	Send the device in for repair.
Defective output signals	<ul style="list-style-type: none"> Incorrect connection of the sensor Incorrect setting of the DIP switch The device is programmed via PC, but the DIP switches are not in the OFF position 	<ul style="list-style-type: none"> Check the connections. Adjust the DIP switches correctly.
"LF1"/"LF2" LED (red) is lit	<ul style="list-style-type: none"> Incorrect connection of the switching element Switching element does not function according to NAMUR 	<ul style="list-style-type: none"> Ensure correct wiring of the switching element. Connect the de-energised contacts to additional resistors accordingly.
"LF1"/"LF2" LED (red) is blinking	Outside measuring range	Configure the measuring range accordingly.

If the error cannot be eliminated using the specified procedures:

- Contact R. STAHL Schaltgeräte GmbH.

For rapid processing, have the following information ready:

- Type and serial number of the device
- Purchase information
- Error description
- Intended purpose (especially input/output circuit)

11 Maintenance, Overhaul, Repair

11.1 Maintenance

- Consult the relevant national regulations to determine the type and extent of inspections.
- Tailor inspection intervals to the operating conditions.

At a minimum, check the following points during maintenance on the device:

- Whether the clamping screws holding the electrical lines fit securely
- Whether the device has cracks or other visible signs of damage
- Whether the permissible ambient temperatures are observed
- Whether it functions as intended

11.2 Maintenance

The device does not require regular maintenance.

	Observe the relevant national regulations in the country of use.
---	--

11.3 Repair

	DANGER
	<p>Explosion hazard due to improper repair! Non-compliance results in severe or fatal injuries.</p> <ul style="list-style-type: none"> • Repair work on the devices must be performed only by R. STAHL Schaltgeräte GmbH.

11.4 Returning the Device

- Only return or package the devices after consulting R. STAHL!
Contact the responsible representative from R. STAHL.

R. STAHL's customer service is available to handle returns if repair or service is required.

- Contact customer service personally.

or

- Go to the r-stahl.com website.
- Under "Support" > "RMA" > select "RMA-REQUEST".
- Fill out the form and send it in.
You will automatically receive an RMA form via email.
Please print this file off.
- Send the device along with the RMA form in the packaging to
R. STAHL Schaltgeräte GmbH (refer to chapter 1.1 for the address).

12 Cleaning

- Devices located in hazardous areas may only be cleaned with a damp cloth to avoid electrostatic charge.
- When cleaning with a damp cloth, use water or mild, non-abrasive, non-scratching cleaning agents.
- Do not use abrasive cleaning agents or solvents.

13 Disposal

- Observe national, local and statutory regulations regarding disposal.
- Separate materials for recycling.
- Ensure environmentally friendly disposal of all components according to statutory regulations.

14 Accessories and Spare Parts

NOTICE

Malfunction or damage to the device due to the use of non-original components.

Non-compliance may lead to material damage.

- Use only original accessories and spare parts from
R. STAHL Schaltgeräte GmbH.



For accessories and spare parts, see the data sheet on our homepage r-stahl.com.