

Trennübertrager ohne Hilfsenergie Feldstromkreis Ex i

Isolating Repeater Loop Powered Field Circuit Ex i

Reihe 9167

Series 9167

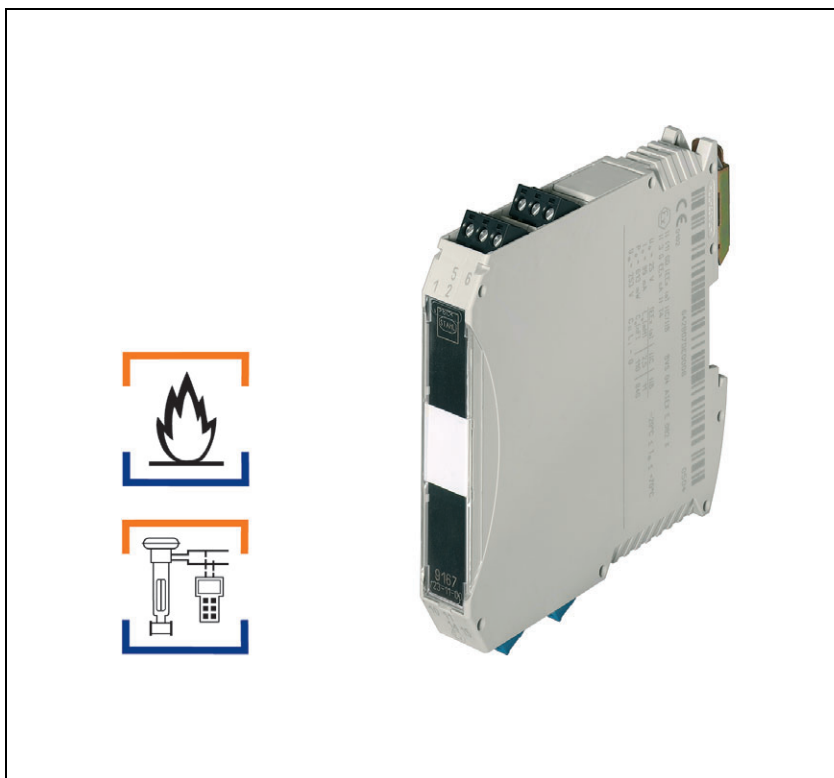

Trennübertrager ohne Hilfsenergie Feldstromkreis Ex i

Reihe 9167



Inhaltsverzeichnis

1	Allgemeine Angaben	3
1.1	Hersteller	3
1.2	Angaben zur Betriebsanleitung	3
1.3	Weitere Dokumente	3
1.4	Konformität zu Normen und Bestimmungen	3
2	Erläuterung der Symbole	4
2.1	Symbole in der Betriebsanleitung	4
2.2	Warnhinweise	4
2.3	Symbole am Gerät	5
3	Sicherheitshinweise	5
3.1	Aufbewahrung der Betriebsanleitung	5
3.2	Sichere Verwendung	5
3.3	Umbauten und Änderungen	6
4	Funktion und Geräteaufbau	6
4.1	Funktion	7
4.2	Geräteaufbau	7
5	Technische Daten	7
6	Projektierung	11
7	Transport und Lagerung	11
8	Montage und Installation	11
8.1	Maßangaben / Befestigungsmaße	12
8.2	Montage / Demontage, Gebrauchslage	12
8.3	Installation	14
9	Inbetriebnahme	14
10	Betrieb	14
11	Instandhaltung, Wartung, Reparatur	15
11.1	Instandhaltung	15
11.2	Wartung	15
11.3	Reparatur	15
11.4	Rücksendung	15
12	Reinigung	15
13	Entsorgung	16
14	Zubehör und Ersatzteile	16

1 Allgemeine Angaben

1.1 Hersteller

R. STAHL Schaltgeräte GmbH
Am Bahnhof 30
74638 Waldenburg
Germany

Tel.: +49 7942 943-0
Fax: +49 7942 943-4333
Internet: www.stahl-ex.com
E-Mail: info@stahl.de

1.2 Angaben zur Betriebsanleitung

ID-Nr.: 160256 / 9167601310
Publikationsnummer: 2015-12-21 BA00 III de 03
Hardwareversion: A
Softwareversion:

Die Originalbetriebsanleitung ist die englische Ausgabe.
Diese ist rechtsverbindlich in allen juristischen Angelegenheiten.

1.3 Weitere Dokumente

- Installationsanleitung Schaltschrank
- Datenblatt 9167
- FMEDA Report SIL

Weitere Sprachen, siehe www.stahl-ex.com.

1.4 Konformität zu Normen und Bestimmungen

Siehe Zertifikate und EG-Konformitätserklärung: www.stahl-ex.com.

Das Gerät verfügt über eine IECEx-Zulassung. Siehe IECEx-Homepage:

<http://iecex.iec.ch/>

Weitere nationale Zertifikate stehen unter dem folgenden Link zum Download bereit:
<http://www.r-stahl.com/downloads/certificates.html>.

2 Erläuterung der Symbole

2.1 Symbole in der Betriebsanleitung

Symbol	Bedeutung
	Tipps und Empfehlungen zum Gebrauch des Geräts
	Gefahr allgemein
	Gefahr durch explosionsfähige Atmosphäre





2.2 Warnhinweise

Warnhinweise unbedingt befolgen, um das konstruktive und durch den Betrieb bedingte Risiko zu minimieren. Die Warnhinweise sind wie folgt aufgebaut:

- Signalwort: GEFAHR, WARNUNG, VORSICHT, HINWEIS
- Art und Quelle der Gefahr/des Schadens
- Folgen der Gefahr
- Ergreifen von Gegenmaßnahmen zum Vermeiden der Gefahr bzw. des Schadens

	GEFAHR
	Gefahren für Personen Nichtbeachtung der Anweisung führt zu schweren oder tödlichen Verletzungen bei Personen.
	WARNUNG
	Gefahren für Personen Nichtbeachtung der Anweisung kann zu schweren oder tödlichen Verletzungen bei Personen führen.
	VORSICHT
	Gefahren für Personen Nichtbeachtung der Anweisung kann zu leichten Verletzungen bei Personen führen.
HINWEIS	
Vermeidung von Sachschaden Nichtbeachtung der Anweisung kann zu einem Sachschaden am Gerät und/oder seiner Umgebung führen.	

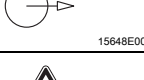
2.3 Symbole am Gerät

Symbol	Bedeutung
	CE-Kennzeichnung gemäß aktuell gültiger Richtlinie.
	Stromkreis gemäß Kennzeichnung für explosionsgefährdete Bereiche zertifiziert.
	Eingang
	Ausgang
	Sicherheitshinweise, welche unerlässlich zur Kenntnis genommen werden müssen: Bei Geräten mit diesem Symbol, sind die entsprechenden Daten und / oder die sicherheitsrelevanten Hinweise der Betriebsanleitung zu beachten!

3 Sicherheitshinweise

3.1 Aufbewahrung der Betriebsanleitung

- Betriebsanleitung sorgfältig lesen.
- Betriebsanleitung am Einbauort des Geräts aufbewahren.
- Mitgeltende Dokumente und Betriebsanleitungen der anzuschließenden Geräte beachten.

3.2 Sichere Verwendung

Vor der Montage

- Sicherheitshinweise in dieser Betriebsanleitung lesen und beachten!
- Sicherstellen, dass der Inhalt dieser Betriebsanleitung vom zuständigen Personal voll verstanden wurde.
- Gerät nur bestimmungsgemäß und nur für den zugelassenen Einsatzzweck verwenden.
- Bei Betriebsbedingungen, die durch die technischen Daten des Geräts nicht abgedeckt werden, unbedingt bei der R. STAHL Schaltgeräte GmbH rückfragen.
- Für die Projektierung das Dokument "Installationsanleitung Schaltschrank" beachten (Download über www.stahl-ex.com, Produktdokumentation, Unterpunkt "Projektierung").
- Für Schäden, die durch fehlerhaften oder unzulässigen Einsatz des Geräts sowie durch Nichtbeachtung dieser Betriebsanleitung entstehen, besteht keine Haftung.



Bei Montage und Installation

- Nationale Montage- und Errichtungsvorschriften beachten (z.B. IEC/EN 60079-14).
- Nationale Sicherheits- und Unfallverhütungsvorschriften beachten.
- Bei Installation und im Betrieb die Angaben (Kennwerte und Bemessungsbetriebsbedingungen) auf Typ- und Datenschildern sowie die Hinweisschilder am Gerät beachten.
- Vor Installation sicherstellen, dass das Gerät unbeschädigt ist.
- Stromkreise der Zündschutzart "Ex i", die mit Stromkreisen anderer Zündschutzarten betrieben wurden, dürfen danach nicht mehr als Stromkreise der Zündschutzart "Ex i" betrieben werden.
- An die eigensicheren Signalstromkreise dürfen, auch bei Einsatz in Zone 2 und Zone 22, eigensichere Geräte der Zonen 1, 0, 21 und 20 angeschlossen werden.
- Die sicherheitstechnischen Werte der angeschlossenen Feldgeräte müssen mit den Angaben des Datenblattes bzw. der EG-Baumusterprüfbescheinigung übereinstimmen.

Wartung, Reparatur, Inbetriebnahme

- Vor Inbetriebnahme sicherstellen, dass das Gerät unbeschädigt ist.
- Arbeiten am Gerät, wie Installation, Instandhaltung, Wartung, Störungsbeseitigung, nur von dazu befugtem und entsprechend geschultem Personal durchführen lassen.
- Nur Wartungsarbeiten bzw. Reparaturen durchführen, die in dieser Betriebsanleitung beschrieben sind.
- Gerät nur bis Stufe SIL 3 (IEC 61508) einsetzen.
- Das Gerät enthält Bauteile, die durch elektrostatische Entladung beschädigt werden können. Vor Arbeiten am Gerät Körper an geerdeten Metallteilen entladen bzw. ein ESD-Ableitband anlegen.

3.3 Umbauten und Änderungen

	GEFAHR
	Explosionsgefahr durch Umbauten und Änderungen am Gerät! Nichtbeachten führt zu schweren oder tödlichen Verletzungen. <ul style="list-style-type: none"> • Gerät nicht umbauen oder verändern.
	Für Schäden, die durch Umbauten und Änderungen entstehen, besteht keine Haftung und keine Gewährleistung.

4 Funktion und Geräteaufbau

	GEFAHR
	Explosionsgefahr durch zweckentfremdete Verwendung! Nichtbeachten führt zu schweren oder tödlichen Verletzungen. <ul style="list-style-type: none"> • Gerät nur entsprechend den in dieser Betriebsanleitung festgelegten Betriebsbedingungen verwenden. • Gerät nur entsprechend dem in dieser Betriebsanleitung genannten Einsatzzweck verwenden.

4.1 Funktion

Einsatzbereich

Der Trennübertrager wird zum eigensicheren Betrieb von Regelventilen, i/p-Umformern, analogen und digitalen Anzeigern sowie Feuer- und Gas-Detektoren eingesetzt.

Arbeitsweise

Das Gerät überträgt ein überlagertes HART-Kommunikationssignal bidirektional. Eine separate Hilfsenergieversorgung ist nicht notwendig.

4.2 Geräteaufbau

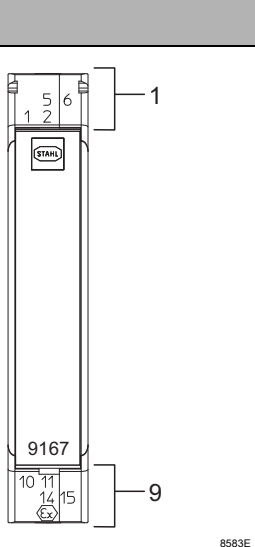
	#	Geräteelement	Beschreibung
	1	Schwarze Klemmen	Anschlussklemmen für den sicheren Bereich
	9	Blaue Klemmen	Anschlussklemmen für den Ex-Bereich (eigensicher Ex i)

5 Technische Daten

Kennzeichnung

Typbezeichnung 9167/ab-11-00 (a=1,2; b=1,3,4)

CE-Kennzeichnung C€₀₁₅₈

Explosionsschutz

Global (IECEX)

Gas und Staub	IECEX BVS 11.0089X Ex nA [ia Ga] IIC T4 Gc [Ex ia Da] IIIC
---------------	--

Europa (ATEX)

Gas und Staub	BVS 04 ATEX E 082 X ⊕ II 3 (1) G Ex nA [ia Ga] IIC T4 Gc ⊕ II (1) D [Ex ia Da] IIIC
---------------	---

Bescheinigungen und Zertifikate

Bescheinigungen	IECEX, ATEX, Brasilien (INMETRO), Kanada (cFM), Kasachstan (TR), Korea (KCs), Russland (TR), Ukraine (TR), USA (FM, UL), Weißrussland (TR)
Schiffszertifikate	DNV GL

Weitere Parameter

Weitere Angaben	siehe jeweilige Bescheinigung und Betriebsanleitung
-----------------	---

Explosionsschutz

Ausführung	9167/.1-11-00, max. 360 Ω	9167/.3-11-00, max. 800 Ω	9167/.4-11-00, max. 590 Ω
------------	------------------------------	------------------------------	------------------------------

Sicherheitstechnische Daten

Max. Spannung U_o	15,7 V	25 V	18,8 V
Max. Strom I_o	60 mA	99 mA	107 mA
Max. Leistung P_o	233 mW	613 mW	503 mW
Max. anschließbare Kapazität C_o			
IIC	487 nF	110 nF	266 nF
IIB	2950 nF	840 nF	1620 nF
Max. anschließbare Induktivität L_o			
IIC	10 mH	2,5 mH	3 mH
IIB	40 mH	11 mH	12 mH
Innere Kapazität C_i	vernachlässigbar		
Innere Induktivität L_i	vernachlässigbar		
Sicherheitstechnische Maximalspannung	253 V AC		

Technische Daten

Ausführung	9167/.1-11-00, max. 360 Ω	9167/.3-11-00, max. 800 Ω	9167/.4-11-00, max. 590 Ω
------------	------------------------------	------------------------------	------------------------------

Elektrische Daten

Hilfsenergie			
Versorgung	ohne		
Max. Verlustleistung je Kanal			
20 mA	0,2 W		
40 mA	0,6 W		
Eingang			
Eingangssignal I_E	0/4 ... 20 mA mit HART		
Funktionsbereich	0 ... 40 mA		
Innenwiderstand R_i			
(bei 20 mA)	410 Ω	380 Ω	320 Ω
(bei 40 mA)	360 Ω	330 Ω	270 Ω
zuzüglich konstanter Spannungsabfall ΔU	1 V		
Eigenverbrauch	$\leq 10 \mu A$		
Eingangsspannung U_E	$\leq 31,2 V$		

Technische Daten

Max. wirksame Spannung $U_{E\text{ eff}}$	15,4 V	23,6 V	18,2 V
Verpolschutz	ja		
Ex i Ausgang			
Ausgangssignal	0/4 ... 20 mA mit HART		
Funktionsbereich	0 ... 40 mA		
Max. Lastwiderstand R_L (bei $I_A = 20\text{ mA}$, $U_{E\text{ eff}}$)	360 Ω	800 Ω	590 Ω
Restwelligkeit des Stromes	$\leq 0,5\%$		
Maximale Ausgangsspannung	15,7 V	25 V	18,8 V
Maximaler Ausgangsstrom	$\leq 60\text{ mA}$	$\leq 99\text{ mA}$	$\leq 107\text{ mA}$
Einstellzeit (10 ... 90 %)	$\leq 1\text{ ms}$		
Fehlererkennung Ex i Ausgang			
Drahtbruch	0 mA		
Verhalten des Eingangsstroms bei Drahtbruch	$\leq 1,0\text{ mA}$		
Umgebungsbedingungen			
Umgebungstemperatur			
Einzelgerät	-20 ... +70 °C		
Gruppenmontage	-20 ... +70 °C		
	Einbaubedingungen beeinflussen die Umgebungstemperatur. "Installationsanleitung Schaltschrank" beachten		
Lagertemperatur	-40 ... +80 °C		
Relative Feuchte (keine Betauung)	$\leq 95\%$		
Verwendung in Höhe	< 2000 m		

Technische Daten

Mechanische Daten

Anschluss

	Schraubklemmen	Federzugklemmen
Anschluss einadrig		
- starr	0,2 ... 2,5 mm ²	0,2 ... 2,5 mm ²
- flexibel	0,2 ... 2,5 mm ²	0,2 ... 2,5 mm ²
- flexibel mit Aderendhülsen (ohne / mit Kunststoffhülse)	0,25 ... 2,5 mm ²	0,25 ... 2,5 mm ²
Anschluss zweiadrig		
- starr	0,2 ... 1 mm ²	-
- flexibel	0,2 ... 1,5 mm ²	-
- flexibel mit Aderendhülsen	0,25 ... 1 mm ²	0,5 ... 1 mm ²

Technische Daten

Montage / Installation

Anschlussplan

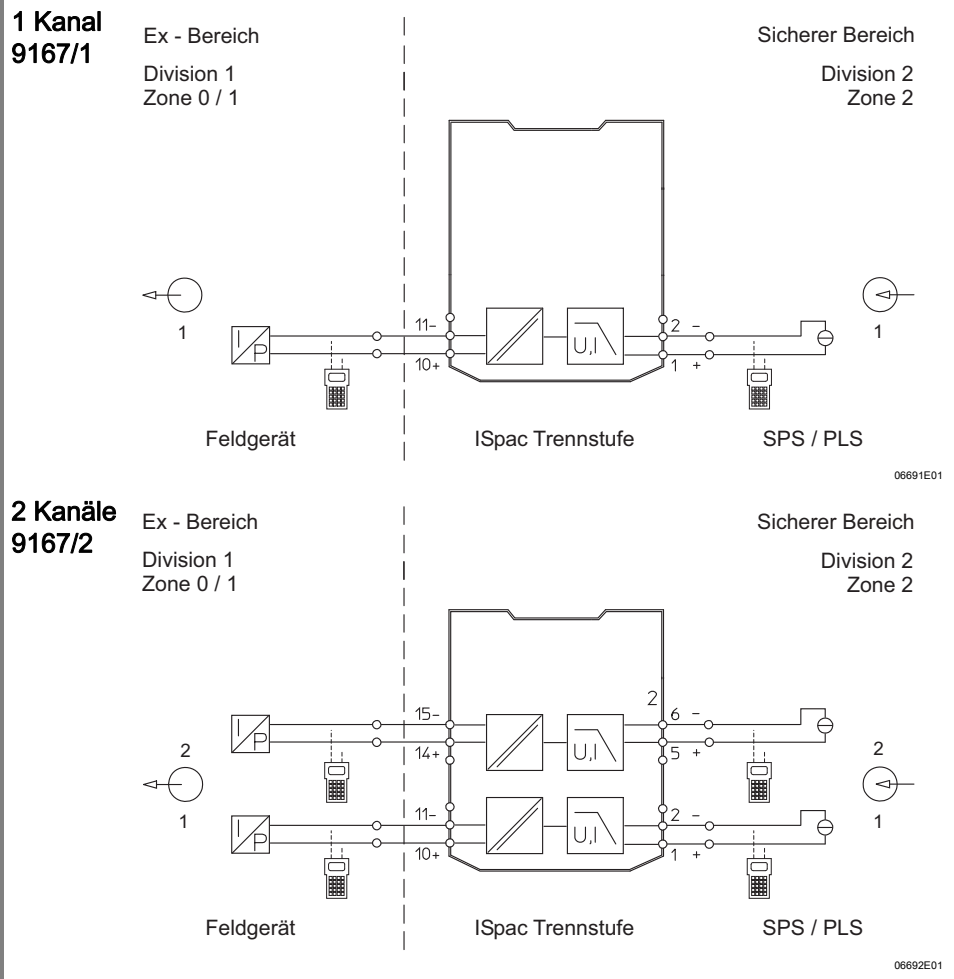

Weitere technische Daten, siehe www.stahl-ex.com.

6 Projektierung

	GEFAHR
	<p>Explosionsgefahr durch zu hohe Temperatur im Schaltschrank! Nichtbeachten führt zu schweren oder tödlichen Verletzungen!</p> <ul style="list-style-type: none"> • Schaltschrank so aufbauen und einrichten, dass er immer innerhalb des zulässigen Temperaturbereichs betrieben wird. • "Installationsanleitung Schaltschrank" sorgfältig beachten.

7 Transport und Lagerung

- Gerät nur in Originalverpackung transportieren und lagern.
- Gerät trocken (keine Batauung) und erschütterungsfrei lagern.
- Gerät nicht stürzen.

8 Montage und Installation

Das Gerät ist für den Einsatz in gasexplosionsgefährdeten Bereichen der Zone 2, in staubexplosionsgefährdeten Bereichen der Zone 22 sowie auch im sicheren Bereich zugelassen.

	GEFAHR
	<p>Explosionsgefahr bei Installation ohne zugelassenes Feldgehäuse! Nichtbeachten führt zu schweren oder tödlichen Verletzungen!</p> <ul style="list-style-type: none"> • Gerät in explosionsgefährdeten Bereichen (Zone 2 oder 22) in ein Gehäuse einbauen, das die Anforderungen der IEC/EN 60079-15 oder der IEC/EN 60079-31 erfüllt.

	GEFAHR
	<p>Explosionsgefahr durch falsche Installation des Geräts! Nichtbeachten führt zu schweren oder tödlichen Verletzungen.</p> <ul style="list-style-type: none"> • Installation strikt nach Anleitung und unter Berücksichtigung der nationalen Sicherheits- und Unfallverhütungsvorschriften durchführen, damit der Explosionsschutz erhalten bleibt. • Das elektrische Gerät so auswählen bzw. installieren, dass der Explosionsschutz aufgrund äußerer Einflüsse nicht beeinträchtigt wird, z.B. Druckbedingungen, chemische, mechanische, thermische, elektrische Einflüsse sowie Schwingungen, Feuchte, Korrosion (siehe IEC/EN 60079-14). • Gerät nur durch geschultes und mit den einschlägigen Normen vertrautes Fachpersonal installieren lassen.

8.1 Maßangaben / Befestigungsmaße

Maßzeichnungen (alle Maße in mm / Zoll) – Änderungen vorbehalten

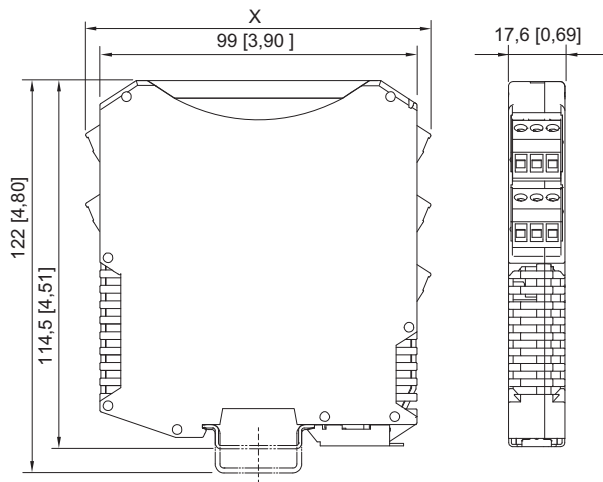

	Maß X
Schraubklemmen	108 mm / 4,25"
Federzugklemmen	128 mm / 5,04"

09685E00

8.2 Montage / Demontage, Gebrauchslage

8.2.1 Montage / Demontage von Gerät auf Hutschiene

Montage auf Hutschiene

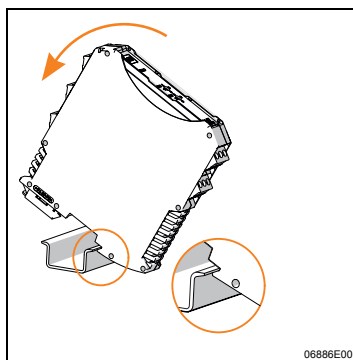

06886E00

- Gerät an die Hutschiene ansetzen: Aussparung des Gehäuses dabei auf die Außenkante der Hutschiene setzen.
- Gerät auf Hutschiene aufrasten.
- Beim Aufschwenken des Geräts auf die Hutschiene darauf achten, dass es nicht verkantet.

Demontage

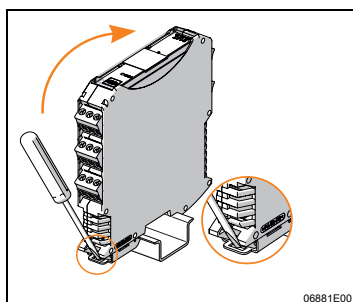

06881E00

- Fußriegel mit dem Schraubendreher etwas herausziehen.
- Gerät herausschwenken.

8.2.2 Montage / Demontage auf pac-Träger

Montage

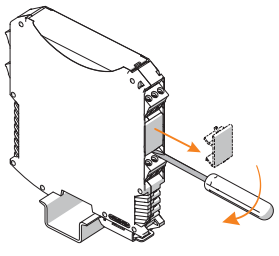
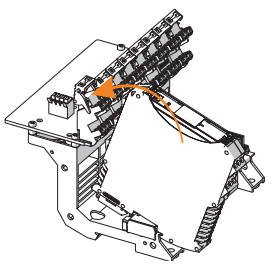
 <p>12613E00</p>	<ul style="list-style-type: none"> • Schwarze und grüne Klemmen entfernen. • Bei einkanaligen Geräten: Abdeckung im Klemmschacht 2 entfernen (zwischen schwarzer und grüner Klemme).
 <p>15569E00</p>	<ul style="list-style-type: none"> • Gerät auf pac-Träger aufsetzen. Dabei die Aussparung des Gehäuses auf die Außenkante des pac-Trägers setzen. • Beim Aufschwenken des Geräts auf den pac-Träger darauf achten, dass es nicht verkantet. • Das Gerät bis zum roten Rasthebel einschwenken. • Roten Rasthebel durch schrägen Druck mit dem Daumen auf den Hebel schließen, bis dieser hörbar am Gerät einrastet. • Sicherstellen, dass der rote Rasthebel eingerastet ist.

Demontage

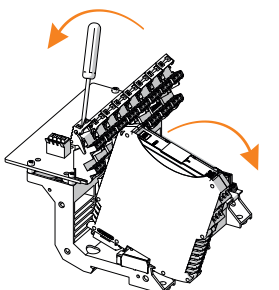
 <p>15574E00</p>	<ul style="list-style-type: none"> • Rasthebel mit einem Schraubendreher ausschwenken. • Gerät aus dem Steckplatz ausschwenken.
--	---

8.2.3 Montage / Demontage steckbare Klemmen

Alle Geräte sind mit steckbaren Klemmen ausgestattet.

Montage

- Klemme in Gerät stecken, bis Klemme einrastet.

Demontage

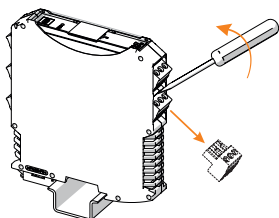
 <p>10859E00</p>	<ul style="list-style-type: none"> • Schraubendreher hinter Klemme ansetzen. • Klemme herausdrücken.
---	--

8.3 Installation

i	Bei Betrieb unter erschwerten Bedingungen wie insbesondere auf Schiffen sind zusätzliche Maßnahmen zur korrekten Installation je nach Einsatzort zu treffen. Weitere Informationen und Anweisungen hierzu erhalten Sie gerne auf Anfrage von Ihrem zuständigen Vertriebskontakt.
----------	--

8.3.1 Elektrische Anschlüsse

	GEFAHR
	<p>Explosionsgefahr durch zu hohe Spannung! Nichtbeachten führt zu schweren oder tödlichen Verletzungen.</p> <ul style="list-style-type: none"> • Gerät nur an Betriebsmittel mit interner Spannung U_m: max. 253 V AC / 50 Hz anschließen. • Gerät nur an eigensichere Klemmen anschließen.
	HINWEIS
	<p>Geräteausfall durch elektrostatisch überladene Bauelemente! Nichtbeachten kann Sachschaden verursachen!</p> <ul style="list-style-type: none"> • Vor Arbeiten am Gerät körpereigene Spannung an geerdeten Metallteilen entladen oder ein ESD-Ableitband anlegen.

8.3.2 Prinzipschaltbilder

Siehe technische Daten oder Geräteaufdruck.

9 Inbetriebnahme

	GEFAHR
	<p>Explosionsgefahr durch fehlerhafte Installation! Nichtbeachten führt zu schweren oder tödlichen Verletzungen.</p> <ul style="list-style-type: none"> • Gerät vor der Inbetriebnahme auf korrekte Installation prüfen. • Nationale Bestimmungen einhalten.

Vor Inbetriebnahme Folgendes sicherstellen:

- Vorschriftsmäßige Installation des Gerätes.
- Richtiger Anschluss der Kabel.
- Keine Schäden am Gerät und an Anschlusskabeln.
- Fester Sitz der Schrauben an den Klemmen. Richtiges Anzugsdrehmoment: 0,5 ... 0,6 Nm.

10 Betrieb

Grundfunktion: Analogausgang 0/4 ... 20 mA, 1 und 2 Kanäle.

Das Gerät überträgt ein überlagertes HART-Kommunikationssignal bidirektional.

Eine separate Hilfsenergieversorgung ist nicht notwendig.

11 Instandhaltung, Wartung, Reparatur

11.1 Instandhaltung

- Art und Umfang der Prüfungen den entsprechenden nationalen Vorschriften entnehmen.
- Prüfungsintervalle an Betriebsbedingungen anpassen.

Bei der Instandhaltung des Geräts mindestens folgende Punkte prüfen:

- fester Sitz der untergeklemmten Leitungen,
- Rissbildung und andere sichtbare Schäden am Gerätegehäuse und / oder Schutzgehäuse,
- Einhaltung der zulässigen Umgebungstemperaturen,
- bestimmungsgemäße Funktion.

11.2 Wartung

Das Gerät benötigt keine regelmäßige Wartung.

	Die geltenden nationalen Bestimmungen im Einsatzland beachten.
---	--

11.3 Reparatur

	GEFAHR
	<p>Explosionsgefahr durch unsachgemäße Reparatur! Nichtbeachten führt zu schweren oder tödlichen Verletzungen.</p> <ul style="list-style-type: none"> • Reparaturen an den Geräten ausschließlich durch R. STAHL Schaltgeräte GmbH ausführen lassen.

11.4 Rücksendung

Für die Rücksendung im Reparatur- bzw. Servicefall das Formular "Serviceschein" verwenden. Auf der Internetseite "www.stahl-ex.com" im Menü "Downloads > Kundenservice":

- Serviceschein herunterladen.
- Serviceschein ausfüllen.
- Gerät zusammen mit dem Serviceschein in der Originalverpackung an die R. STAHL Schaltgeräte GmbH senden.

12 Reinigung

- Zur Vermeidung elektrostatischer Aufladung dürfen die Module in explosionsgefährdeten Bereichen nur mit einem feuchten Tuch gereinigt werden.
- Bei feuchter Reinigung: Wasser oder milde, nicht scheuernde, nicht kratzende Reinigungsmittel verwenden.
- Keine aggressiven Reinigungsmittel oder Lösungsmittel verwenden.

13 Entsorgung

- Nationale und lokal gültige Vorschriften und gesetzliche Bestimmungen zur Entsorgung beachten.
- Materialien getrennt dem Recycling zuführen.
- Umweltgerechte Entsorgung aller Bauteile gemäß den gesetzlichen Bestimmungen sicherstellen.

14 Zubehör und Ersatzteile

HINWEIS

Fehlfunktion oder Geräteschaden durch den Einsatz nicht originaler Bauteile.
Nichtbeachten kann Sachschaden verursachen!

- Nur Original-Zubehör und Original-Ersatzteile der R. STAHL Schaltgeräte GmbH verwenden.



Zubehör und Ersatzteile, siehe Datenblatt auf Homepage www.stahl-ex.com.

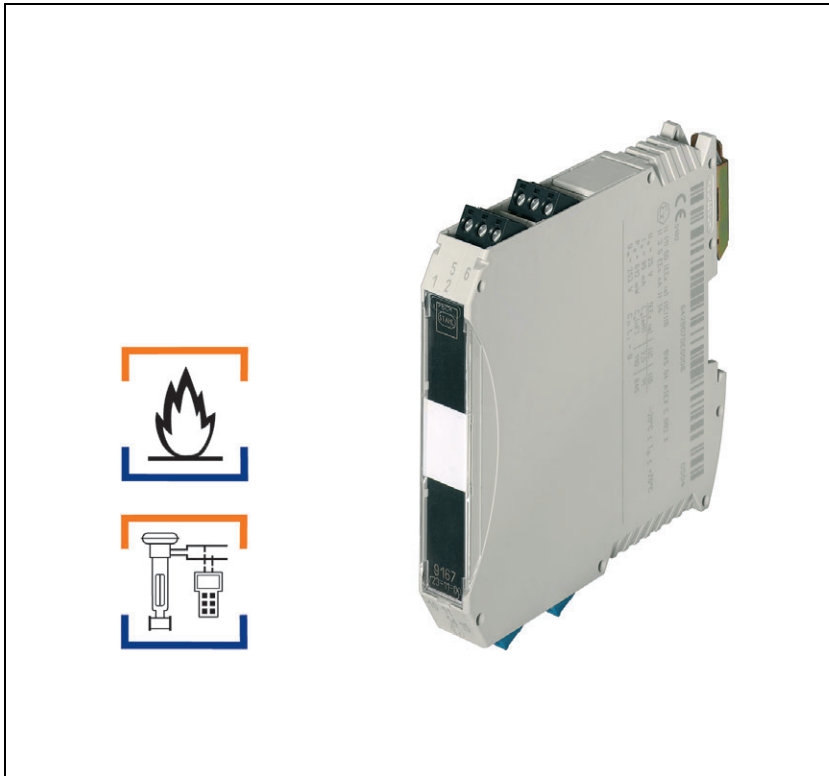

Isolating Repeater Loop Powered Field Circuit Ex i

Series 9167



Contents

1	General Information	3
1.1	Manufacturer	3
1.2	Information regarding the operating instructions	3
1.3	Further documents	3
1.4	Conformity with standards and regulations	3
2	Explanation of the symbols	4
2.1	Symbols in these operating instructions	4
2.2	Warning notes	4
2.3	Symbols on the device	5
3	Safety notes	5
3.1	Operating instructions storage	5
3.2	Safe use	5
3.3	Modifications and alterations	6
4	Function and device design	6
4.1	Function	7
4.2	Device design	7
5	Technical data	7
6	Engineering	11
7	Transport and storage	11
8	Mounting and installation	11
8.1	Dimensions / fastening dimensions	12
8.2	Mounting / dismantling, operating position	12
8.3	Installation	14
9	Commissioning	14
10	Operation	14
11	Maintenance and repair	15
11.1	Maintenance	15
11.2	Maintenance	15
11.3	Repair	15
11.4	Returning the device	15
12	Cleaning	15
13	Disposal	16
14	Accessories and Spare parts	16

1 General Information

1.1 Manufacturer

R. STAHL Schaltgeräte GmbH
Am Bahnhof 30
74638 Waldenburg
Germany

Phone: +49 7942 943-0
Fax: +49 7942 943-4333
Internet: www.stahl-ex.com
E-Mail: info@stahl.de

1.2 Information regarding the operating instructions

ID-No.: 160256 / 9167601310
Publication Code: 2015-12-21 BA00 III en 03
Hardware version: A
Software version:

The original instructions are the English edition.
They are legally binding in all legal affairs.

1.3 Further documents

- Cabinet installation guide
 - Data sheet 9167
 - FMEDA SIL Report
- For further languages, see www.stahl-ex.com.

1.4 Conformity with standards and regulations

See certificates and EC Declaration of Conformity: www.stahl-ex.com.
The device has IECEx approval. See IECEx homepage: <http://iecex.iec.ch/>
Further national certificates can be downloaded via the following link:
<http://www.r-stahl.com/downloads/certificates.html>.

2 Explanation of the symbols

2.1 Symbols in these operating instructions

Symbol	Meaning
	Tips and recommendations on the use of the device
	General danger
	Danger due to explosive atmosphere





2.2 Warning notes

Warnings must be observed under all circumstances, in order to minimize the risk due to construction and operation. The warning notes have the following structure:

- Signalling word: DANGER, WARNING, CAUTION, NOTICE
- Type and source of danger/damage
- Consequences of danger
- Taking countermeasures to avoid the danger or damage

	DANGER
	Danger to persons Non-compliance with the instruction results in severe or fatal injuries to persons.
	WARNING
	Danger to persons Non-compliance with the instruction can result in severe or fatal injuries to persons.
	CAUTION
	Danger to persons Non-compliance with the instruction can result in light injuries to persons.
NOTICE	
Avoiding material damage Non-compliance with the instruction can result in material damage to the device and / or its environment.	

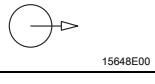
2.3 Symbols on the device

Symbol	Meaning
 0158 <small>05594E00</small>	CE marking according to the current applicable directive.
 02198E00	According to marking, electric circuit certified for hazardous areas.
 15649E00	Input
 15648E00	Output
	Safety instructions that must always be followed: For devices with this symbol, the respective data must be noted and / or the safety-relevant instructions contained in the operating instructions must be followed!

3 Safety notes

3.1 Operating instructions storage

- Read the operating instructions carefully.
- Store the operating instructions at the mounting location of the device.
- Observe applicable documents and operating instructions of the devices to be connected.

3.2 Safe use

Before mounting

- Read and observe the safety notes in these operating instructions!
- Ensure that the contents of these operating instructions are fully understood by the personnel in charge.
- Use the device in accordance with its intended and approved purpose only.
- Always consult with R. STAHL Schaltgeräte GmbH if using the device under operating conditions which are not covered by the technical data.
- Observe the document "Cabinet installation guide" for engineering (download from www.stahl-ex.com, product documentation, subitem "Engineering").
- We cannot be held liable for damage at the device caused by incorrect or unauthorized use or non-compliance with these operating instructions.



For mounting and installation

- Observe national installation regulations (e.g. IEC/EN 60079-14).
- Observe national safety and accident prevention regulations.
- During installation and operation, observe the information (characteristic values and rated operating conditions) on the rating, data and information plates located on the device.
- Before installation, make sure that the device is not damaged.
- Electric circuits with type of protection "Ex i" operated with circuits with other types of protection can no longer be operated as circuits with type of protection "Ex i" after that.
- When used in Zones 2 and 22, the intrinsically safe devices of Zones 1, 0, 21 and 20 can be connected to the intrinsically safe signal circuits.
- The safety characteristic values of the connected field devices must correspond to the specifications in the data sheet or in the EC Type Examination Certificate.

Maintenance, repair, commissioning

- Before commissioning, make sure that the device is not damaged.
- Work on the device, such as installation, maintenance, overhaul, repair, may only be carried out by appropriately authorised and trained personnel.
- Perform only maintenance work or repair described in these operating instructions.
- Only use the device up to SIL 3 (IEC 61508).
- The device contains components that can be damaged by electrostatic discharge. Before carrying out work on the device, the body must be discharged on earthed metal parts or an ESD wrist strap must be put on.

3.3 Modifications and alterations

	DANGER
	Explosion hazard due to modifications and alterations to the device! Non-compliance results in severe or fatal injuries. <ul style="list-style-type: none"> • Do not modify or alter the device.
	No liability or warranty for damage resulting from modifications and alterations.

4 Function and device design

	DANGER
	Explosion hazard due to improper use! Non-compliance results in severe or fatal injuries. <ul style="list-style-type: none"> • Use the device only in accordance with the operating conditions described in these operating instructions. • Use the device only for the intended purpose specified in these operating instructions.

4.1 Function

Application range

The isolating repeater is used for intrinsically safe operation of control valves, I/P converters, analog and digital indicators as well as flame and gas detectors.

Mode of operation

The device transmits a superimposed HART communication signal bidirectionally. A separate auxiliary power source is not necessary.

4.2 Device design

	#	Device component	Description
	1	Black terminals	Connection terminals for the safe area
	9	Blue terminals	Connection terminals for the hazardous area (intrinsically safe Ex i)

5 Technical data

Marking

Type designation 9167/ab-11-00 (a=1,2; b=1,3,4)
 CE marking C₀₁₅₈

Explosion Protection

Global (IECEX)

Gas and dust | IECEx BVS 11.0089X
 Ex nA [ia Ga] IIC T4 Gc
 [Ex ia Da] IIIC

Europe (ATEX)

Gas and dust | BVS 04 ATEX E 082 X
 Ⓢ II 3 (1) G Ex nA [ia Ga] IIC T4 Gc
 Ⓢ II (1) D [Ex ia Da] IIIC

Certifications and certificates

Certificates | IECEx, ATEX, Brazil (INMETRO), Canada (cFM), Kazakhstan (TR), Korea (KCs), Russia (TR), Ukraine (TR), USA (FM, UL), Belarus (TR)
 Ship approval | DNV GL

Further parameters

Further information | see respective certificate and operating instructions

Explosion Protection

Version	9167/.1-11-00, max. 360 Ω	9167/.3-11-00, max. 800 Ω	9167/.4-11-00, max. 590 Ω
---------	------------------------------	------------------------------	------------------------------

Safety data

Max. voltage U_o	15.7 V	25 V	18.8 V
Max. current I_o	60 mA	99 mA	107 mA
Max. power P_o	233 mW	613 mW	503 mW
Max. connectable capacitance C_o			
IIC	487 nF	110 nF	266 nF
IIB	2950 nF	840 nF	1620 nF
Max. connectable inductance L_o			
IIC	10 mH	2.5 mH	3 mH
IIB	40 mH	11 mH	12 mH
Internal capacitance C_i	negligible		
Internal inductance L_i	negligible		
Safety-related maximum voltage	253 V AC		

Technical Data

Version	9167/.1-11-00, max. 360 Ω	9167/.3-11-00, max. 800 Ω	9167/.4-11-00, max. 590 Ω
---------	------------------------------	------------------------------	------------------------------

Electrical data

Auxiliary power			
Supply	without		
Max. power losses per channel			
20 mA	0.2W		
40 mA	0.6W		
Input			
Input signal I_E	0/4 ... 20 mA with HART		
Functional range	0 ... 40 mA		
Internal resistance R_i			
(at 20 mA)	410 Ω	380 Ω	320 Ω
(at 40 mA)	360 Ω	330 Ω	270 Ω
additional constant voltage drop ΔU	1 V		
Own consumption	$\leq 10 \mu A$		
Input voltage U_E	$\leq 31.2 V$		

Technical Data

Max. effective voltage $U_{E\text{ eff}}$	15.4 V	23.6 V	18.2 V
Polarity reversal protection	yes		
Ex i output			
Output signal	0/4 ... 20 mA with HART		
Function range	0 ... 40 mA		
Max. Load resistance R_L (at $I_{\text{out}} = 20\text{ mA}$, $U_{E\text{ eff}}$)	360 Ω	800 Ω	590 Ω
Residual ripple of current	$\leq 0.5\%$		
Max. output voltage	15,7 V	25 V	18,8 V
Max. output current	$\leq 60\text{ mA}$	$\leq 99\text{ mA}$	$\leq 107\text{ mA}$
Response time (10 ... 90 %)	$\leq 1\text{ ms}$		
Fault detection Ex i output			
Open-circuit	0 mA		
Behaviour of output current at open-circuit	$\leq 1.0\text{ mA}$		
Ambient conditions			
Ambient temperature			
Single device	-20 ... +70 °C		
Group assembly	-20 ... +70 °C		
	The installation conditions affect the ambient temperature. Observe the "Cabinet installation guide"		
Storage temperature	-40 ... +80 °C		
Relative humidity (no condensation)	$\leq 95\%$		
Use at the height of	< 2000 m		

Technical Data

Mechanical data

Connection

	Screw terminals	Spring clamp terminals
Single-wire connection		
- rigid	0.2 ... 2.5 mm ²	0.2 ... 2.5 mm ²
- flexible	0.2 ... 2.5 mm ²	0.2 ... 2.5 mm ²
- flexible with core end sleeves (without / with plastic sleeve)	0.25 ... 2.5 mm ²	0.25 ... 2.5 mm ²
two-wire connection		
- rigid	0.2 ... 1 mm ²	–
- flexible	0.2 ... 1.5 mm ²	–
- flexible with core end sleeves	0.25 ... 1 mm ²	0.5 ... 1 mm ²

Technical Data

Mounting / Installation

Connection diagram

1 channel 9167/1

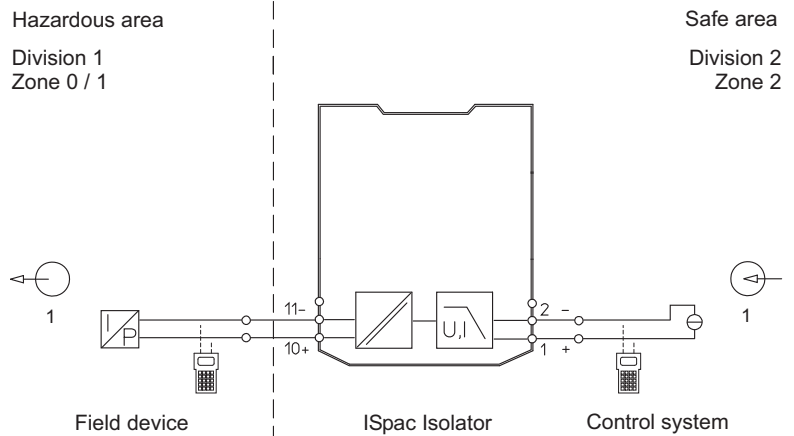

2 channels 9167/2

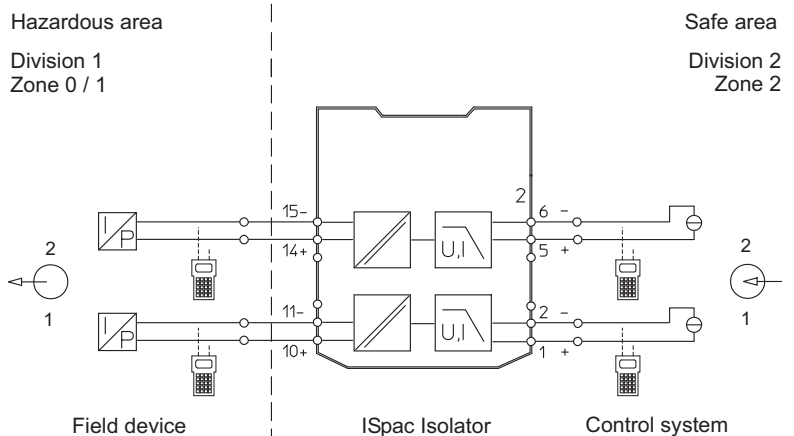

For further technical data, see www.stahl-ex.com.

6 Engineering

	DANGER
	<p>Explosion hazard due to too high temperature in the cabinet! Non-compliance results in severe or fatal injuries!</p> <ul style="list-style-type: none"> • Install and adjust the cabinet in such a way that it is always operated within the permissible temperature range. • Carefully observe the "Cabinet installation guide".

7 Transport and storage

- Transport and store the device only in the original packaging.
- Store the device in a dry place (no condensation) and vibration-free.
- Do not drop the device.

8 Mounting and installation

The device is approved for use in gas explosion hazardous areas of Zone 2 and dust explosion hazardous area of Zone 22 and in safe areas.

	DANGER
	<p>Explosion hazard due to installation without approved field enclosure! Non-compliance results in severe or fatal injuries!</p> <ul style="list-style-type: none"> • In hazardous areas (Zone 2 or 22), the device must be installed in an enclosure which fulfils the requirements of IEC/EN 60079-15 or IEC/EN 60079-31.

	DANGER
	<p>Explosion hazard due to incorrect installation of the device! Non-compliance results in severe or fatal injuries.</p> <ul style="list-style-type: none"> • Carry out installation strictly according to the instructions and national safety and accident prevention regulations to maintain the explosion protection. • Select and install the electrical device so that explosion protection is not affected due to external influences, i.e. pressure conditions, chemical, mechanical, thermal and electric impact such as vibration, humidity and corrosion (see IEC/EN 60079-14). • The device must only be installed by trained qualified personnel who is familiar with the relevant standards.

8.1 Dimensions / fastening dimensions

Dimensional Drawings (All Dimensions in mm / inches) – Subject to Alterations

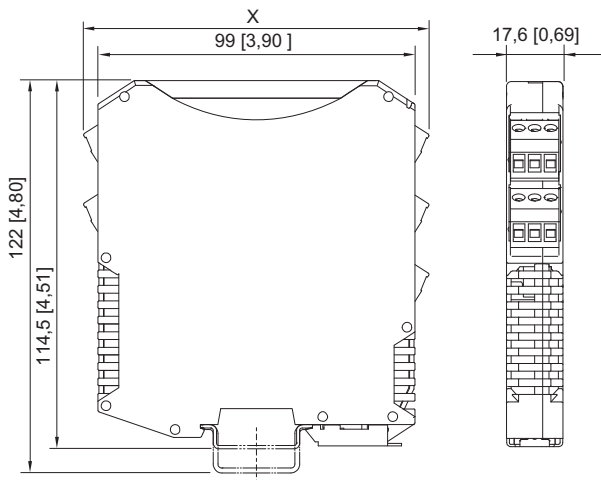

	Dimension X
Screw terminals	108 mm / 4.25"
Spring clamp terminals	128 mm / 5.04"

09685E00

8.2 Mounting / dismounting, operating position

8.2.1 Mounting / dismounting of the device on top hat rail

Mounting on top hat rail

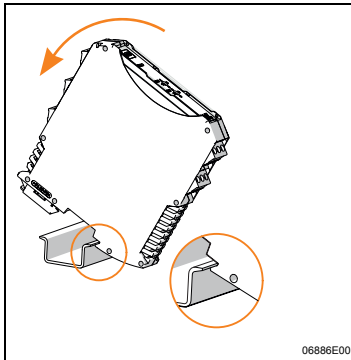

06886E00

- Position the device on the top hat rail. Position the cut-out of the enclosure on the outside edge of the top hat rail.
- Engage the device on the top hat rail.
- When swivelling the device onto the top hat rail, make sure that it is not set at an angle.

Dismounting

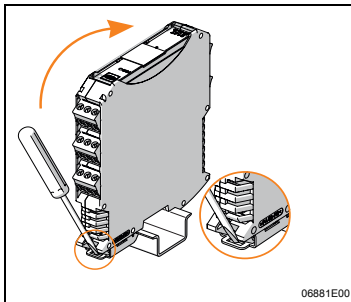

06881E00

- Pull out the base bolt somewhat using a screwdriver.
- Swivel out the device.

8.2.2 Mounting / dismantling on pac-Carrier

Mounting

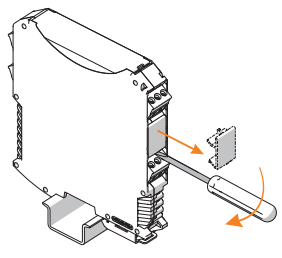
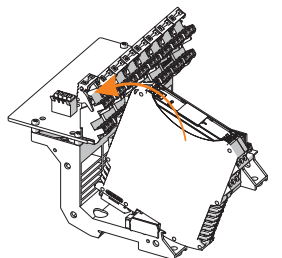
 <p>12613E00</p>	<ul style="list-style-type: none"> • Remove the black and green terminals. • For single-channel devices: remove the covering in terminal slot 2 (between the black and the green terminal).
 <p>15569E00</p>	<ul style="list-style-type: none"> • Position the device on the pac-Carrier. Place the cut-out of the enclosure on the outside edge of the pac-Carrier. • When pivoting the device onto the pac-Carrier, make sure that it is not set at an angle. • Swivel in the device up to the red notch lever. • Close red notch lever by applying diagonal pressure on the lever with the thumb until the lever engages audibly at the device. • Ensure that the red notch lever is engaged.

Dismounting

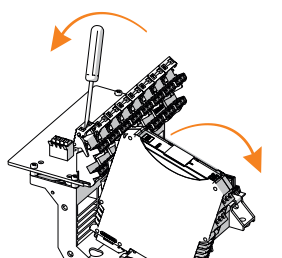
 <p>15574E00</p>	<ul style="list-style-type: none"> • Swivel out the notch lever using a screwdriver. • Swivel device out of the slot.
--	---

8.2.3 Mounting / dismantling pluggable terminals

All devices are equipped with pluggable terminals.

Mounting

- Plug the terminal into the device until the terminal engages.

Dismounting

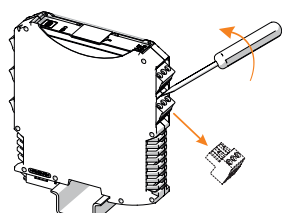
 <p>10859E00</p>	<ul style="list-style-type: none"> • Position the screwdriver behind the terminal. • Push out the terminal.
---	---

8.3 Installation

i	Operation under difficult conditions, such as, in particular, on ships, requires additional measures to be taken for correct installation, depending on the place of use. Further information and instructions on this can be obtained from your regional sales contact on request.
----------	---

8.3.1 Electrical connections

	DANGER
	<p>Explosion hazard caused by too high voltage! Non-compliance results in severe or fatal injuries.</p> <ul style="list-style-type: none"> • Connect the device only to equipment with internal voltage U_m: max. 253 V AC / 50 Hz. • Connect the device only to intrinsically safe terminals.
NOTICE	
<p>Device failure due to electrostatically overcharged components! Non-compliance can result in material damage!</p> <ul style="list-style-type: none"> • Before carrying out work on the device, the body's own voltage must be discharged on earthed metal parts or an ESD wrist strap must be put on. 	

8.3.2 Schematic diagrams

See technical data or device labelling.

9 Commissioning

	DANGER
	<p>Explosion hazard due to incorrect installation! Non-compliance results in severe or fatal injuries.</p> <ul style="list-style-type: none"> • Check the device for proper installation before commissioning. • Comply with national regulations.

Before commissioning, ensure the following:

- Installation of the device according to regulations.
- Correct connection of the cables.
- No damage at the device and connection cables.
- Tight seat of the screws at the terminals. Correct tightening torque: 0.5 ... 0.6 Nm.

10 Operation

Basic function: analog output 0/4 ... 20 mA, 1 and 2 channels.

The device transmits a superimposed HART communication signal bidirectionally.

A separate auxiliary power source is not necessary.

11 Maintenance and repair

11.1 Maintenance

- Consult the relevant national regulations to determine the type and extent of inspections.
- Adapt inspection intervals to the operating conditions.

During maintenance of the device, check at least:

- whether the clamping screws holding the electric lines are securely seated,
- whether the device enclosure and / or protective enclosure have cracks or other visible signs of damage,
- whether the permissible ambient temperatures are observed,
- whether the device is used according to its designated use.

11.2 Maintenance

The device does not require regular maintenance.

	Observe the relevant national regulations in the country of use.
---	--

11.3 Repair

	DANGER
	<p>Explosion hazard due to improper repair! Non-compliance results in severe or fatal injuries.</p> <ul style="list-style-type: none"> • Repair work on the devices must be performed only by R. STAHL Schaltgeräte GmbH.

11.4 Returning the device

Use the "Service form" to return the device if repair or service is required. On the internet site "www.stahl-ex.com" under "Downloads > Customer service":

- Download the service form.
- Fill out the service form.
- Send the device along with the service form in the original packaging to R. STAHL Schaltgeräte GmbH.

12 Cleaning

- To avoid electrostatic charging, the modules located in hazardous areas must be cleaned with a damp cloth only.
- When cleaning with a damp cloth, use water or mild, non-abrasive, non-scratching cleaning agents.
- Do not use aggressive detergents or solvents.

13 Disposal

- Observe national and local regulations and statutory regulation regarding disposal.
- Separate materials when sending it for recycling.
- Ensure environmentally friendly disposal of all components according to the statutory regulations.

14 Accessories and Spare parts

NOTE

Malfunction or damage to the device due to the use of non-original components.
Non-compliance can result in material damage.

- Use only original accessories and spare parts from R. STAHL Schaltgeräte GmbH.



For accessories and spare parts, see data sheet on our homepage
www.stahl-ex.com.

EG/EU-Konformitätserklärung
EC/EU Declaration of Conformity
Déclaration de Conformité CE/UE

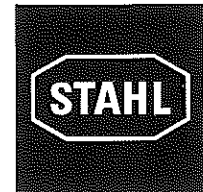

R. STAHL Schaltgeräte GmbH • Am Bahnhof 30 • 74638 Waldenburg, Germany
 erklärt in alleiniger Verantwortung / declares in its sole responsibility / déclare sous sa seule responsabilité

dass das Produkt:
 that the product:
 que le produit:

Trennübertrager ohne Hilfsenergie
Isolating Repeater Loop Powered
Isolateur sans Alimentation

Typ(en) / type(s) / type(s):

9167/ab-11-00 (a = 1, 2; b = 1, 3, 4)

mit den Anforderungen der folgenden Richtlinien und Normen übereinstimmt.
 is in conformity with the requirements of the following directives and standards.
 est conforme aux exigences des directives et des normes suivantes.

Richtlinie(n) / Directive(s) / Directive(s)		Norm(en) / Standard(s) / Norme(s)
Bis / Until / Jusqu'au 2016-04-19:	Ab / From / Du 2016-04-20:	IEC 60079-0:2011 IEC 60079-11:2011 EN 60079-15:2010 EN 60079-26:2007
94/9/EG	ATEX-Richtlinie	2014/34/EU
94/9/EC	ATEX Directive	2014/34/EU
94/9/CE	Directive ATEX	2014/34/UE

Kennzeichnung / marking / marquage:

II 3 (1) G Ex nA [Ia Ga] IIC T4 Gc
 II (1) D [Ex ia Da] IIC

0158

EG-Baumusterprüfbescheinigung:
 EC Type Examination Certificate:
 Attestation d'examen CE de type:

BVS 04 ATEX E 082 X
 (DEKRA EXAM GmbH,
 Dinnendahlstraße 9, 44809 Bochum, Germany, NB0158)

Produktnormen nach Niederspannungsrichtlinie:
 Product standards according to Low Voltage Directive:
 Normes des produit pour la Directive Basse Tension:

In Anlehnung / According to / Selon:
 EN 50178:1997
 EN 61010-1:2010

Bis / Until / Jusqu'au 2016-04-19:	Ab / From / Du 2016-04-20:	EN 61326-1:2013 EN 61326-3-2:2008
2004/108/EG	EMV-Richtlinie	2014/30/EU
2004/108/EC	EMC Directive	2014/30/EU
2004/108/CE	Directive CEM	2014/30/UE

2011/65/EU **RoHS-Richtlinie**
 2011/65/EU *RoHS Directive*
 2011/65/UE *Directive RoHS*

EN 50581:2012

Waldenburg, 2016-01-19

Ort und Datum
 Place and date
 Lieu et date

i.V.

Carsten Brenner
 Leiter Geschäftsbereich Automation
 Vice President Business Unit Automation
 Vice-président Business Unit Automation

i.V.

J.-P. Rückgauer
 Leiter Qualitätsmanagement
 Director Quality Management
 Directeur Assurance de Qualité

Type 9167/**-11-00

Hazardous area

Safe area

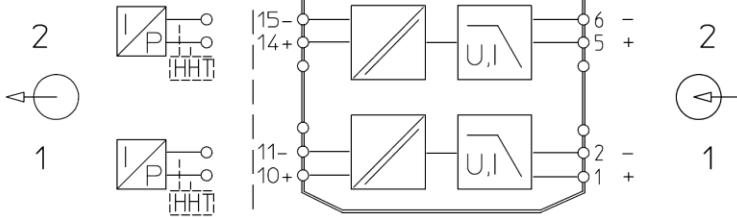

Hazardous area: Class I, II, III; DIV 1; Group A-G or Class I; Zone 0; Group IIC/IIB Hazardous Locations
 Safe area: Non-Hazardous; Division 2 or Zone 2 Hazardous (Classified) Locations

The Isolating Repeater Loop Powered Type 9167 is an associated apparatus as well as a nonincendive apparatus for installation in Non-Hazardous, Class I, Division 2 or Zone 2 Hazardous (Classified) Locations providing intrinsically safe connections for one (or two) field devices located in Class I, II, III, Division 1, Group A-G or Class I, Zone 0 [AEx ia] Group IIC, Hazardous Locations according to NEC Article 504/505 as listed below.

Isolating Repeater Loop Powered Type 9167/ab-11-00

a = numeral 1 or 2 for number of channels
 b = numeral 1, 3 or 4 for output signal

Entity parameters for wiring configurations are as follows:

	V _{oc} [V]	I _{sc} [mA]	P _o [mW]	L _o CL I, DIV 1, A,B / Zone 0, GP IIC	L _o CL I, DIV 1, C-G / Zone 0, GP IIB	C _o CL I, DIV 1, A,B / Zone 0, GP IIC	C _o CL I, DIV 1, C-G / Zone 0, GP IIB	V _{max}	I _{max}
Type 9167/*1-11-00	15.7	60	233	10 mH	40 mH	487 nF	2950 nF	-	-
Type 9167/*3-11-00	25	99	613	2.5 mH	11 mH	110 nF	840 nF	-	-
Type 9167/*4-11-00	18.8	107	503	3 mH	12 mH	266 nF	1620 nF	-	-

Notes:

- Intrinsically safe apparatus may be switches, thermocouples, LEDs, RTDs or an FM Approved System or Entity device connected in accordance with the manufacturer's installation instructions.
- For Entity concept use the appropriate parameters to ensure the following:
 V_t or $V_{oc} \leq V_{max}$ $C_o, C_a \geq C_i + C_{leads}$ $P_o \leq P_i$
 I_t or $I_{sc} \leq I_{max}$ $L_o, L_a \geq L_i + L_{leads}$
- Electrical apparatus connected to an intrinsically safe system should not use or generate voltages > 250 V (U_{max}).
- Installation should be in accordance with Article 504/505 of the National Electrical Code, ANSI/NFPA 70 and ANSI/ISA RP 12.06.01.
- Installation in Canada should be in accordance with the Canadian Electrical Code, CSA C22.1, Part 1, Appendix F.
- Use a general purpose enclosure meeting the requirements of IEC 61010-1 for use in Non-Hazardous or Class I, Division 2, Hazardous (Classified) Locations.
- Use an FM Approved Dust-ignition proof enclosure appropriate for environmental protection in Class II, Division 1, Groups E, F and G; and Class III, Hazardous (Classified) Locations.
- These modules are to be mounted on DIN rail, DIN rail with pac-Bus (type 9194) or pac-Carrier (type 9195). The field wiring in any case is connected to the ISpac device terminals.
- Ambient temperature: -20°C ... +70°C (any mounting position)

WARNING: Do not disconnect equipment when a flammable or combustible atmosphere is present.
 AVERTISSEMENT: Ne pas débrancher l'équipement en présence d'atmosphère inflammable ou combustible.

The safety relevant statements of this document may be transferred into the operating instructions. Transferring the text, editorial changes of equivalent meaning are allowed.

			2007	Date	Name	Certification drawing	Scale
			drawn	04.05.	Einsiedler		none
			checked		Kaiser		Sheet 1 of 1
						Isolating Repeater HART Input Type 9167/**-11-00	Agency
							FM
02	22.10.12	Reistle	STAHL			91 676 01 31 1	
01	24.08.11	Reistle					
Version	Date	Name	Ers. f.	Ers. d.			A4

The copying, distribution and utilization of this document as well as the communication of its contents to others without expressed authorization is prohibited. Offenders will be held liable for the payment of damages. All rights reserved in the event of the grant of a patent, utility model or ornamental design registration.

Weitergabe sowie Vervielfältigung dieses Dokuments, Verwertung und Mitteilung seines Inhalts sind verboten, soweit nicht ausdrücklich gestattet. Zuwiderhandlungen verpflichten zu Schadensersatz. Alle Rechte für den Fall der Patent-, Gebrauchsmuster- oder Geschmackschutzregistrierung vorbehalten.

Type 9167/**-11-00

Hazardous area

Safe area

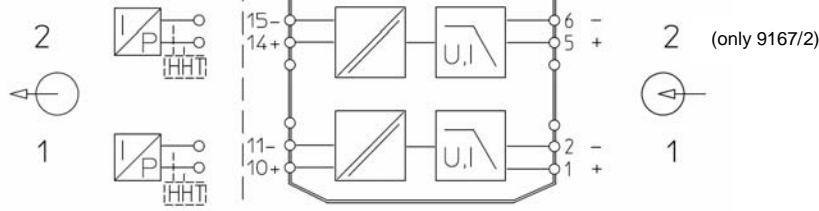

Hazardous area: Class I, II, III; Div. 1; Group A-G; Hazardous Locations
 Safe area: Non-hazardous Locations

The Isolating Repeater Loop Powered Type 9167 is an associated apparatus and provides intrinsically safe connections for one (or two) field devices located in Class I, II, III, Division 1, Group A-G, hazardous locations according to NEC Article 504 as listed below.

Isolating Repeater Loop Powered Type 9167/ab-11-00

a = numeral 1 or 2 for number of channels
 b = numeral 1, 3 or 4 for output signal

Entity parameters for wiring configurations are as follows:

	V _{OC}	I _{SC}	P _O	L _o CL.I, Div.1, A,B	L _o CL.I, Div.1, C-G	C _o CL.I, Div.1,A,B	C _o CL.I, Div.1, C-G
Type 9167/*1-11-00	15.7 V	60 mA	233 mW	10 mH	40 mH	487 nF	2950 nF
Type 9167/*3-11-00	25 V	99 mA	613 mW	2.5 mH	11 mH	110 nF	840 nF
Type 9167/*4-11-00	18.8 V	107 mA	503 mW	3 mH	12 mH	266 nF	1620 nF

Notes:

- Intrinsically safe apparatus may be Simple Apparatus in accordance with Article 504 of the National Electrical Code, ANSI/NFPA 70 (for example: switches, thermocouples, LEDs, RTDs) a third-party certified or Entity device connected in accordance with the manufacturer's installation instructions.
- For Entity concept use the appropriate parameters to ensure the following:

$$V_t \text{ or } V_{OC} \leq V_{max} \quad C_a \geq C_i + C_{Cable}$$

$$I_t \text{ or } I_{SC} \leq I_{max} \quad L_a \geq L_i + L_{Cable}$$
- Capacitance and inductance of the field wiring from the intrinsically safe equipment to the associated apparatus shall be calculated and must be included in the system calculations as shown above. Cable capacitance (C_c) plus intrinsically safe equipment capacitance (C_i) must be less than the marked capacitance (C_a or C_o) shown on any associated apparatus used. The same applies for inductance (L_c, L_i and L_a or L_o, respectively). Where the cable capacitance and inductance per foot are not known, the following values shall be used: C_c=60pF/ft., L_c=0.2μH/ft.
- Electrical apparatus connected to an intrinsically safe system should not use or generate voltages > 250 V (U_{max}).
- Intrinsically safe circuits must be installed, wired and separated in accordance with Article 504.20 of the National Electrical Code (ANSI/NFPA 70)
- Where multiple circuits extend from the same piece of associated apparatus, they must be installed in separate cables or in one cable having suitable insulation. Refer to Article 504 of the National Electrical Code and Instrument Society of America Recommended Practice ISA RP12.6 for installing intrinsically safe equipment.
- Associated Apparatus must be installed in an enclosure suitable for the application in accordance with the National Electrical Code, ANSI/NFPA 70.
- Use an UL or NRTL listed Dust-ignition proof enclosure appropriate for environmental protection in Class II, Division 1, Groups E,F and G; and Class III, hazardous (classified) locations.
- The isolators have not been evaluated for use in electrical combination with other associated apparatus.
- These modules are to be mounted on DIN rail, DIN rail with pac-Bus (type 9194) or pac-Carrier (type 9195). The field wiring in any case is connected to the IS pac device terminals.
- Ambient temperature: -20 °C ... +70 °C (any mounting position)

WARNING: To prevent ignition of flammable or combustible atmospheres disconnect power before servicing

F 4830 503

			2007	Date	Name	Certification drawing Isolating Repeater Loop Powered Type 9167 91 676 01 31 3	Scale
			Drawn by	18.04.	Einsiedler		none
			Checked	18.04.	Kaiser		Sheet 1 of 1
							Agency UL
Index	Date	Name				Rep. f.	Rep. t.
							A4

