



Positionsschalter

Reihe 8074/2

Inhaltsverzeichnis

1	Allgemeine Angaben	3
1.1	Hersteller	3
1.2	Angaben zum Handbuch	3
1.3	Weitere Dokumente	3
1.4	Konformität zu Normen und Bestimmungen	3
2	Erläuterung der Symbole	4
2.1	Symbole im Handbuch	4
2.2	Warnhinweise	4
2.3	Symbole am Gerät	5
3	Sicherheitshinweise	5
3.1	Aufbewahrung des Handbuchs	5
3.2	Qualifikation des Personals	5
3.3	Sichere Verwendung	6
3.4	Umbauten und Änderungen	6
4	Funktion und Geräteaufbau	7
4.1	Funktion	7
5	Technische Daten	8
6	Transport und Lagerung	21
7	Montage und Installation	21
7.1	Maßangaben / Befestigungsmaße	22
7.2	Montage / Demontage, Gebrauchslage	23
7.3	Installation	25
8	Inbetriebnahme	29
9	Instandhaltung, Wartung, Reparatur	29
9.1	Instandhaltung	29
9.2	Wartung	30
9.3	Reparatur	30
9.4	Rücksendung	30
10	Reinigung	31
11	Entsorgung	31
12	Zubehör und Ersatzteile	31

1 Allgemeine Angaben

1.1 Hersteller

R. STAHL Schaltgeräte GmbH
Am Bahnhof 30
74638 Waldenburg
Germany

Tel.: +49 7942 943-0
Fax: +49 7942 943-4333
Internet: r-stahl.com
E-Mail: info@stahl.de

1.2 Angaben zum Handbuch

ID-Nr.: 257036 / 807460300070
Publikationsnummer: 2019-10-25-HB00-III-de-03

Die Originalbetriebsanleitung ist die englische Ausgabe.
Diese ist rechtsverbindlich in allen juristischen Angelegenheiten.

1.3 Weitere Dokumente

- Datenblatt
 - Betriebsanleitung
- Dokumente in weiteren Sprachen, siehe r-stahl.com.

1.4 Konformität zu Normen und Bestimmungen

Zertifikate und EU-Konformitätserklärung, siehe r-stahl.com.
Das Gerät verfügt über eine IECEx-Zulassung. Zertifikat siehe IECEx-Homepage:
<http://iecex.iec.ch/>
Weitere nationale Zertifikate stehen unter dem folgenden Link zum Download bereit:
<https://r-stahl.com/de/global/support/downloads/>.

2 Erläuterung der Symbole

2.1 Symbole im Handbuch

Symbol	Bedeutung
	Tipps und Empfehlungen zum Gebrauch des Geräts
	Gefahr durch explosionsfähige Atmosphäre
	Gefahr durch spannungsführende Teile





2.2 Warnhinweise

Warnhinweise unbedingt befolgen, um das konstruktive und durch den Betrieb bedingte Risiko zu minimieren. Die Warnhinweise sind wie folgt aufgebaut:

- Signalwort: GEFAHR, WARNUNG, VORSICHT, HINWEIS
- Art und Quelle der Gefahr/des Schadens
- Folgen der Gefahr
- Ergreifen von Gegenmaßnahmen zum Vermeiden der Gefahr bzw. des Schadens

	GEFAHR
	Gefahren für Personen Nichtbeachtung der Anweisung führt zu schweren oder tödlichen Verletzungen bei Personen.
	WARNUNG
	Gefahren für Personen Nichtbeachtung der Anweisung kann zu schweren oder tödlichen Verletzungen bei Personen führen.
	VORSICHT
	Gefahren für Personen Nichtbeachtung der Anweisung kann zu leichten Verletzungen bei Personen führen.
HINWEIS	
Vermeidung von Sachschaden Nichtbeachtung der Anweisung kann zu einem Sachschaden am Gerät und/oder seiner Umgebung führen.	

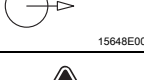
2.3 Symbole am Gerät

Symbol	Bedeutung
	CE-Kennzeichnung gemäß aktuell gültiger Richtlinie.
	Gerät gemäß Kennzeichnung für explosionsgefährdete Bereiche zertifiziert.
	Eingang
	Ausgang
	Sicherheitshinweise, welche unerlässlich zur Kenntnis genommen werden müssen: Bei Geräten mit diesem Symbol sind die entsprechenden Daten und / oder die sicherheitsrelevanten Hinweise in diesem Handbuch zu beachten!

3 Sicherheitshinweise

3.1 Aufbewahrung des Handbuchs

- Handbuch sorgfältig lesen.
- Handbuch am Einbauort des Geräts aufbewahren.
- Mitgeltende Dokumente und Betriebsanleitungen der anzuschließenden Geräte beachten.

3.2 Qualifikation des Personals

Für die in diesem Handbuch beschriebenen Tätigkeiten ist eine entsprechend qualifizierte Fachkraft erforderlich. Dies gilt vor allem für Arbeiten in den Bereichen

- Projektierung
- Montage/Demontage des Geräts
- (Elektrische) Installation
- Inbetriebnahme
- Instandhaltung, Reparatur, Reinigung

Fachkräfte, die diese Tätigkeiten ausführen, müssen einen Kenntnisstand haben, der relevante nationale Normen und Bestimmungen umfasst.

Für Tätigkeiten in explosionsgefährdeten Bereichen sind weitere Kenntnisse erforderlich! R. STAHL empfiehlt einen Kenntnisstand, der in folgenden Normen beschrieben wird:

- IEC/EN 60079-14 (Projektierung, Auswahl und Errichtung elektrischer Anlagen)
- IEC/EN 60079-17 (Prüfung und Instandhaltung elektrischer Anlagen)
- IEC/EN 60079-19 (Gerätereparatur, Überholung und Regenerierung)

3.3 Sichere Verwendung

Vor der Montage

- Sicherheitshinweise in diesem Handbuch lesen und beachten!
- Sicherstellen, dass der Inhalt dieses Handbuchs vom zuständigen Personal voll verstanden wurde.
- Gerät nur bestimmungsgemäß und nur für den zugelassenen Einsatzzweck verwenden.
- Bei Betriebsbedingungen, die durch die technischen Daten des Geräts nicht abgedeckt werden, unbedingt bei der R. STAHL Schaltgeräte GmbH rückfragen.
- Sicherstellen, dass das Gerät unbeschädigt ist.
- Für Schäden, die durch fehlerhaften oder unzulässigen Einsatz des Geräts sowie durch Nichtbeachtung dieses Handbuchs entstehen, besteht keine Haftung.



Bei Montage und Installation

- Montage und Installation nur durch qualifizierte und autorisierte Personen (siehe Kapitel "Qualifikation des Personals") durchführen lassen.
- Gerät nur in Bereichen installieren, für die es aufgrund seiner Kennzeichnung geeignet ist.
- Bei Installation und im Betrieb die Angaben (Kennwerte und Bemessungsbetriebsbedingungen) auf Typ- und Datenschildern sowie die Hinweisschilder am Gerät beachten.
- Vor Installation sicherstellen, dass das Gerät unbeschädigt ist.

Inbetriebnahme, Wartung, Reparatur

- Inbetriebnahme und Instandsetzung nur durch qualifizierte und autorisierte Personen (siehe Kapitel "Qualifikation des Personals") durchführen lassen.
- Vor Inbetriebnahme sicherstellen, dass das Gerät unbeschädigt ist.
- Nur Wartungsarbeiten durchführen, die in diesem Handbuch beschrieben sind.
- Das Gerät darf nicht bei Staubablagerungen ≥ 50 mm Dicke, gem. IEC/EN 61241-0, betrieben werden.

3.4 Umbauten und Änderungen

	<p style="text-align: center;">GEFAHR</p> <p>Explosionsgefahr durch Umbauten und Änderungen am Gerät! Nichtbeachten führt zu schweren oder tödlichen Verletzungen.</p> <ul style="list-style-type: none"> • Gerät nicht umbauen oder verändern.
	<p>Für Schäden, die durch Umbauten und Änderungen entstehen, besteht keine Haftung und keine Gewährleistung.</p>

4 Funktion und Geräteaufbau

	GEFAHR
	<p>Explosionsgefahr durch zweckentfremdete Verwendung! Nichtbeachten führt zu schweren oder tödlichen Verletzungen.</p> <ul style="list-style-type: none"> • Gerät nur entsprechend den in diesem Handbuch festgelegten Betriebsbedingungen verwenden. • Gerät nur entsprechend dem in diesem Handbuch genannten Einsatzzweck verwenden.

4.1 Funktion

Einsatzbereich

Positionsschalter positionieren, steuern und überwachen bewegliche Teile an Maschinen und Anlagen. Da sie die Produktnormen EN 50 041 und IEC 60947-5-1 erfüllen, können sie auch als Positionsschalter mit Sicherheitsfunktion eingesetzt werden. Positionsschalter der Serie 8074/2 sind für den Einsatz in explosionsgefährdeten Bereichen der Zonen 1, 2, 21 und 22 zugelassen.

Arbeitsweise

In Verbindung mit einem Schutztürwächter und entsprechender Beschaltung erreichen die Positionsschalter PL "e" nach EN ISO 13849-1 bzw. bis SIL 3 nach EN 62061. Gekennzeichnet sind sie mit dem Zeichen \ominus für Zwangsöffnung. Es gibt Ausführungen mit Sprung- und Schleichschaltung in verschiedenen Kontaktformen sowie einer Vielzahl unterschiedlicher Betätigungselemente.

5 Technische Daten

Explosionsschutz

Global (IECEx)

Gas und Staub	IECEx BVS 16.0085 Ex d e IIC T6 ... T5 Gb Ex tb IIIC T80°C Db
---------------	---

Europa (ATEX)

Gas und Staub	BVS 05 ATEX E 007 II 2 G Ex d e IIC T6 ... T5 Gb II 2 D Ex tb IIIC T80°C Db
---------------	---

Bescheinigungen und Zertifikate

Bescheinigungen	IECEx, ATEX, weitere siehe r-stahl.com
-----------------	--

Technische Daten

Ausführung	8074/2-.-W, -R, -SR, -DL, -WH, -WPH, -D, -DS, -DD
------------	---

Elektrische Daten

Bemessungs- betriebsspannung U_e			8074/2-1 8074/2-2 8074/2-5	8074/2-3
	Wechselspannung bei gleichem Potential: Wechselspannung bei ungleichem Potential: Gleichspannung:		max. 500 V max. 250 V 125 V	max. 400 V max. 250 V 125 V
Bemessungs- betriebsstrom I_e	4,4 A: +70 °C (T6); 6,6 A: +70 °C (T5)			
Schaltleistung	AC-12	AC-15	DC-12	
	8074/2-1 8074/2-2 8074/2-5	8074/2-3	8074/2-1 8074/2-2 8074/2-5	8074/2-3 8074/2-.
	max. 250 V max. 500 V **) max. 4 A max. 5000 VA	max. 250 V max. 400 V **) max. 4 A max. 4000 VA	max. 250 V max. 500 V **) max. 4 A max. 1000 VA	max. 250 V max. 400 V **) max. 4 A max. 1000 VA
	**) nur bei gleichem Potential			
Bemessungs- isolationsspannung	250 V			
Bemessungsstoß- spannungsfestigkeit	4 kV			
Kurzschlusschutz	10 A gG			

Umgebungsbedingungen

Betriebstemperatur- bereich	-40 ... +70 °C, T6 (max. 4,4 A) -40 ... +70 °C, T5 (max. 6,6 A)
--------------------------------	--

Technische Daten

Ausführung	8074/2-.-AZ-20
-------------------	-----------------------

Elektrische Daten

Bemessungs- betriebsspannung U_e	8074/2-.-AZ-20	
	Wechselspannung:	250 V AC
	Gleichspannung:	230 V DC
Bemessungs- betriebsstrom I_e	max. 6 A: $-20\text{ °C} < T_a < +60\text{ °C}$, 250 V AC; max. 0,25 A: $-20\text{ °C} < T_a < +60\text{ °C}$, 230 V DC	
Schaltleistung	AC-15	DC-13
	max. 250 V max. 6 A	max. 230 V max. 0,25 A
Bemessungs- isolationsspannung	250 V	
Bemessungsstoß- spannungsfestigkeit	4 kV	
Kurzschlusschutz	10 A gG	

Umgebungsbedingungen

Betriebstemperatur- bereich	-20 ... +40 °C (T6) -20 ... +60 °C (T5)
--------------------------------	--

Technische Daten

Ausführung	8074/2-.-W, -R, -SR, -DL, -WH, -WPH, -D, -DS, -DD, -AZ-20
-------------------	--

Mechanische Daten

maximale Schalthäufigkeit	max. 1800 Schaltspiele/h	
Schutzart	IP66 -40 °C (DIN EN 60529)	
Stoßsicherheit	Sprungschaltglied:	2 g
	Schleichschaltglied:	20 g
Material		
Gehäuse	korrosionsbeständiges Aluminium, pulverbeschichtet ähnlich RAL 7016	
Deckel	Edelstahl 1.4401, gestrahlt	

Montage / Installation

Leitungs- einführungen	8161/7-M20.. unten am Gehäuse: 1 x M20 x 1,5	
Anschluss	mit Leitungseinführung 8161: für Mantelleitung 4 x 2,5 mm ² (Ø 4 ... 13 mm); empfohlen 4 x 1,5 mm ²	
Anschlussklemmen	0,75 ... 2,5 mm ² , 0,75 ... 1,5 mm ² (8074/2-.-AZ-20) eindrätig, feindrätig mit oder ohne Aderendhülse; zusätzlicher äußerer Schutzleiteranschluss bis max. 4 mm ²	
Anzugsdrehmoment	Schraubklemmen:	0,4 Nm max.
	Deckelschrauben:	1,5 ... 2 Nm
	Leitungseinführungen:	siehe Montagehinweis (liegt lose bei)

Technische Daten

Kontaktelement

Ausführung

Schleich-
schaltglied

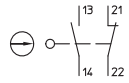

08667E00

8074/2-1

Sprung-
schaltglied

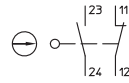

08668E00

8074/2-2

Schleichschaltglied,
überlappend

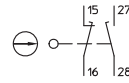

08675E00

8074/2-5

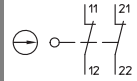

08669E00

8074/2-3

Achtung:
die Funktion Zwangsöffnung ⊖ hängt ab vom
verwendeten Betätiger

Kontaktsystem

2-polig, galvanisch getrennt, mit Doppelunterbrechung

Kontaktöffnungs-
weite

≥ 1,5 mm (Trennstrecke ≥ 3 mm)

Material

Kontakte

Silber-Nickel

Gehäuse

Polyamid, glasfaserverstärkt

Kontaktelement

Lebensdauer

mechanisch

max. 10⁶ Schaltspiele

elektrisch

max. 10⁶ Schaltspiele

Technische Daten

Betätigung, Betätigungs-geschwindigkeit, Schaltwege bzw. Schaltwinkel

Betätigertyp	Betätigung	Schaltbild	Nennschaltwege bzw. Schaltwinkel	Mindestkraft/-moment
Typ 8074/2	V = max. Betätigungs-geschwindigkeit	⊖ = Zwangs-öffnung	■ = Kontakt geschlossen □ = Kontakt offen Zw = Zwangsöffnungsweg	
Stößel 8074/2.-W-40	Bei seitlicher Betätigung: V = 0,5 m/s Betätigung in Hubrichtung: V = 1,0 m/s		in Hubrichtung 8074/2-1: 8074/2-2: 8074/2-3: 8074/2-5: 	22 N

Technische Daten

Betätigung, Betätigungsgeschwindigkeit, Schaltwege bzw. Schaltwinkel

Betätigertyp	Betätigung	Schaltbild	Nennschaltwege bzw. Schaltwinkel	Mindestkraft/-moment
Typ 8074/2	V = max. Betätigungsgeschwindigkeit	⊖ = Zwangsöffnung	■ = Kontakt geschlossen □ = Kontakt offen Zw = Zwangsöffnungsweg	
Rollenstößel 8074/2.-R-40	Bei seitlicher Betätigung: V = 1,0 m/s Betätigung in Hubrichtung: V = 1,0 m/s		<p>in Hubrichtung</p> <p>8074/2-1:</p> <p>18998E00</p> <p>8074/2-2:</p> <p>19051E00</p> <p>8074/2-3:</p> <p>18999E00</p> <p>8074/2-5:</p> <p>19000E00</p>	22 N

18820E00

Technische Daten

Betätigung, Betätigungsgeschwindigkeit, Schaltwege bzw. Schaltwinkel

Betätigertyp	Betätigung	Schaltbild	Nennschaltwege bzw. Schaltwinkel	Mindestkraft/-moment
Typ 8074/2	V = max. Betätigungsgeschwindigkeit	⊕ = Zwangsöffnung	■ = Kontakt geschlossen □ = Kontakt offen Zw = Zwangsöffnungsweg	
Schieflaufschalter 8074/2-.SR-40	Keine Zwangsöffnung, nicht für Sicherheitsstromkreise geeignet		<p>8074/2-1:</p> <p>8074/2-2:</p>	2,5 N

18821E00

Technische Daten

Betätigung, Betätigungsgeschwindigkeit, Schaltwege bzw. Schaltwinkel

Betätigertyp	Betätigung	Schaltbild	Nennschaltwege bzw. Schaltwinkel	Mindestkraft/-moment
Typ 8074/2	V = max. Betätigungsgeschwindigkeit	⊕ = Zwangsöffnung	■ = Kontakt geschlossen □ = Kontakt offen Zw = Zwangsöffnungsweg	
Langer Drehhebel 8074/2-.DL-40			<p>8074/2-1:</p> <p>8074/2-2:</p> <p>8074/2-3:</p> <p>8074/2-5:</p>	3 N

18818E00

Technische Daten

Betätigung, Betätigungsgeschwindigkeit, Schaltwege bzw. Schaltwinkel

Betätigertyp	Betätigung	Schaltbild	Nennschaltwege bzw. Schaltwinkel	Mindestkraft/-moment
Typ 8074/2	V = max. Betätigungsgeschwindigkeit	⊕ = Zwangsöffnung	■ = Kontakt geschlossen □ = Kontakt offen Zw = Zwangsöffnungsweg	
Rollenhebel 8074/2-.-WH-40	V = 1,0 m/s		Auslenkung der Rolle in Hubrichtung des Stößels ab Beginn der Stößelbewegung 8074/2-1: 8074/2-2: 8074/2-3: 8074/2-5: 	18 N

18823E00



Technische Daten

Betätigung, Betätigungsgeschwindigkeit, Schaltwege bzw. Schaltwinkel

Betätigertyp	Betätigung	Schaltbild	Nennschaltwege bzw. Schaltwinkel	Mindestkraft/-moment
Typ 8074/2	V = max. Betätigungsgeschwindigkeit	⊕ = Zwangsöffnung	■ = Kontakt geschlossen □ = Kontakt offen Zw = Zwangsöffnungsweg	
Parallelhebel 8074/2-.-WPH-40	V = 1,0 m/s		Auslenkung der Rolle senkrecht zur Hubrichtung des Stößels ab Beginn der Stößelbewegung 8074/2-1: Zw = 4,7 mm 19004E00 8074/2-2: Zw = 7,6 mm 19059E00 8074/2-3: Zw = 4,5 mm 19005E00 8074/2-5: Zw = 5,0 mm 19057E00	18 N

18824E00



Technische Daten

Betätigung, Betätigungsgeschwindigkeit, Schaltwege bzw. Schaltwinkel

Betätigertyp	Betätigung	Schaltbild	Nennschaltwege bzw. Schaltwinkel	Mindestkraft/-moment
Typ 8074/2	V = max. Betätigungsgeschwindigkeit	⊕ = Zwangsöffnung	■ = Kontakt geschlossen □ = Kontakt offen Zw = Zwangsöffnungsweg	
Drehhebel 8074/2-.D-40	V = 1,5 m/s		<p>8074/2-1:</p> <p>8074/2-2:</p> <p>8074/2-3:</p> <p>8074/2-5:</p>	7 N

18816E00

Technische Daten

Betätigung, Betätigungsgeschwindigkeit, Schaltwege bzw. Schaltwinkel

Betätigertyp	Betätigung	Schaltbild	Nennschaltwege bzw. Schaltwinkel	Mindestkraft/-moment
Typ 8074/2	V = max. Betätigungsgeschwindigkeit	⊖ = Zwangsöffnung	■ = Kontakt geschlossen □ = Kontakt offen Zw = Zwangsöffnungsweg	
Einstellbarer Drehhebel 8074/2.-DS-40	V = 1,5 m/s Keine Zwangsöffnung, nicht für Sicherheitsstromkreise geeignet		8074/2-1: Zw = 45°	4,5 N

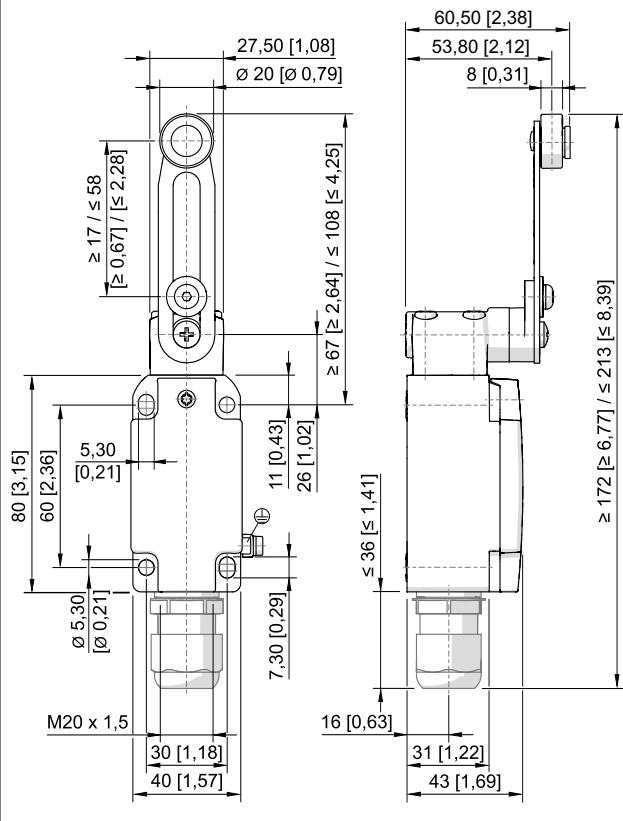

18819E00



Technische Daten

Betätigung, Betätigungsgeschwindigkeit, Schaltwege bzw. Schaltwinkel

Betätigertyp	Betätigung	Schaltbild	Nennschaltwege bzw. Schaltwinkel	Mindestkraft/-moment
Typ 8074/2	V = max. Betätigungsgeschwindigkeit	⊕ = Zwangsöffnung	■ = Kontakt geschlossen □ = Kontakt offen Zw = Zwangsöffnungsweg	
Draht-Drehhebel 8074/2.-DD-40	V = 1,5 m/s Keine Zwangsöffnung, nicht für Sicherheitsstromkreise geeignet		<p>8074/2-1:</p> <p>8074/2-2:</p> <p>8074/2-3:</p> <p>8074/2-5:</p>	2,5 N

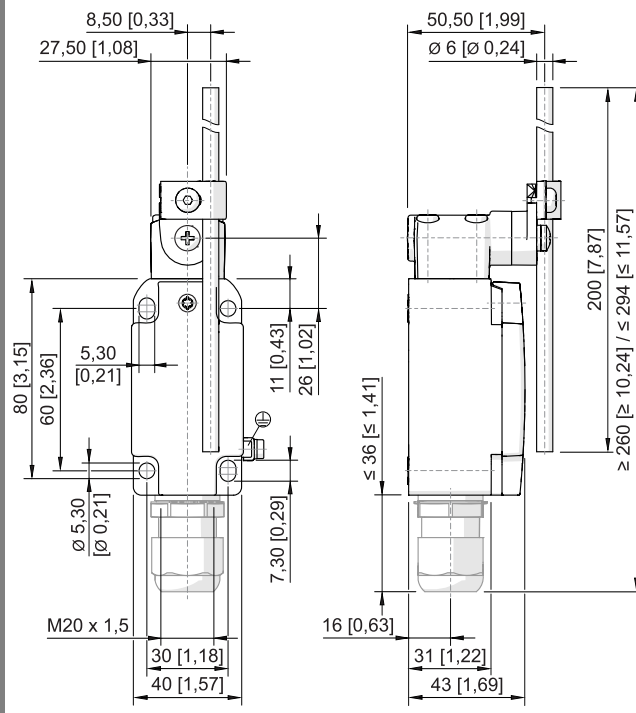

18817E00

Technische Daten

Betätigung, Betätigungsgeschwindigkeit, Schaltwege bzw. Schaltwinkel

Betätigertyp	Betätigung	Schaltbild	Nennschaltwege bzw. Schaltwinkel	Mindestkraft/-moment
Typ 8074/2	V = max. Betätigungsgeschwindigkeit	⊕ = Zwangsöffnung	■ = Kontakt geschlossen □ = Kontakt offen Zw = Zwangsöffnungsweg	
Sicherheitsschalter 8074/2.-AZ-20			8074/2-1: 8074/2-3: 	17 N

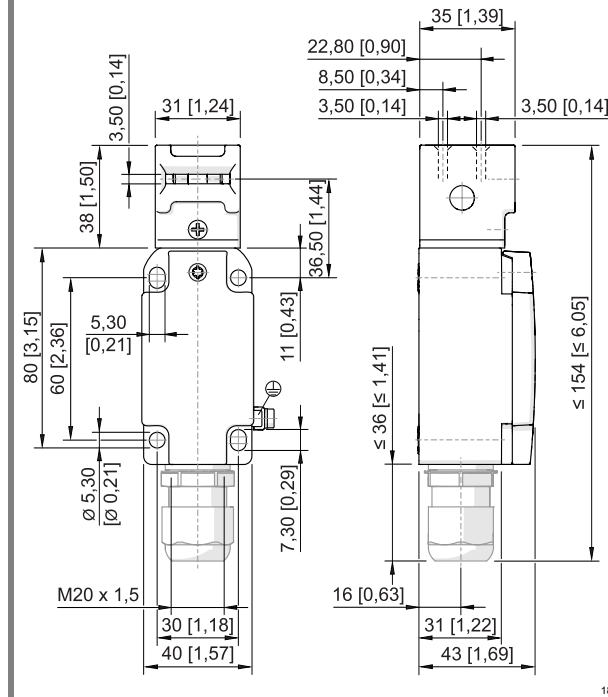

Hinweis:
Darstellung der Schaltwege bei eingeschobenem Betätiger.
Die Betätiger sind separat zu bestellen.

Weitere technische Daten, siehe r-stahl.com.

6 Transport und Lagerung

- Gerät nur in Originalverpackung transportieren und lagern.
- Gerät trocken (keine Betauung) und erschütterungsfrei lagern.
- Gerät nicht stürzen.

7 Montage und Installation

Das Gerät ist für den Einsatz in gasexplosionsgefährdeten Bereichen der Zonen 1 und 2, in staubexplosionsgefährdeten Bereichen der Zonen 21 und 22 sowie auch im sicheren Bereich zugelassen.

GEFAHR	
	<p>Explosionsgefahr durch falsche Installation des Geräts! Nichtbeachten führt zu schweren oder tödlichen Verletzungen.</p> <ul style="list-style-type: none"> • Installation strikt nach Anleitung und unter Berücksichtigung der nationalen Sicherheits- und Unfallverhütungsvorschriften durchführen, damit der Explosionsschutz erhalten bleibt. • Das elektrische Gerät so auswählen bzw. installieren, dass der Explosionsschutz aufgrund äußerer Einflüsse nicht beeinträchtigt wird, z.B. Druckbedingungen, chemische, mechanische, thermische, elektrische Einflüsse sowie Schwingungen, Feuchte, Korrosion (siehe IEC/EN 60079-14). • Gerät nur durch geschultes und mit den einschlägigen Normen vertrautes Fachpersonal installieren lassen.

7.1 Maßangaben / Befestigungsmaße

Maßzeichnungen (alle Maße in mm [Zoll]) – Änderungen vorbehalten

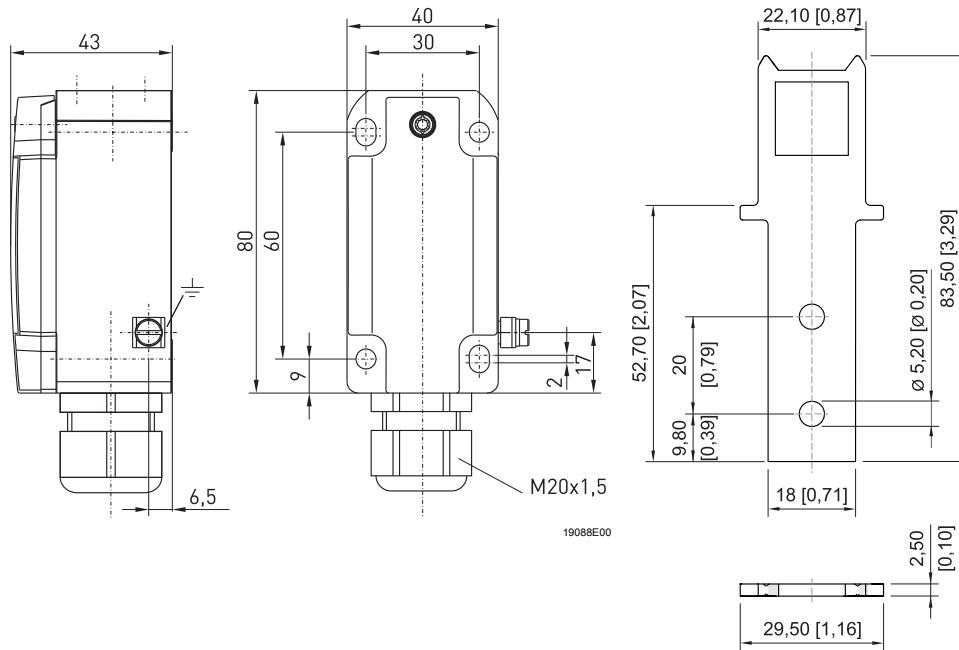

19088E00

18928E00

Positionsschalter 8074/2

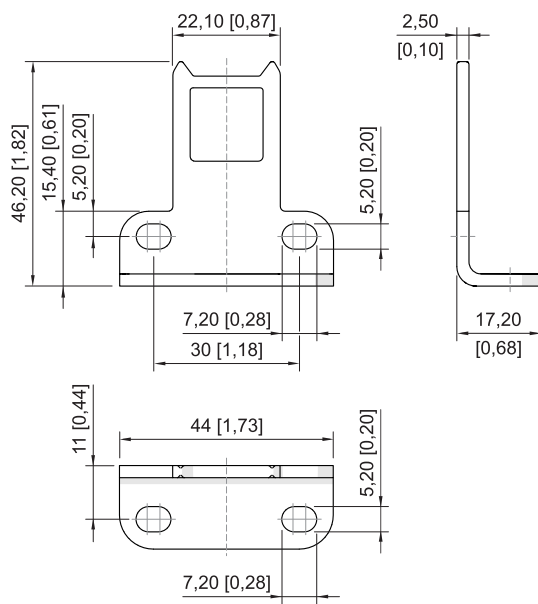

18929E00

Betätiger für Sicherheitsschalter gerade

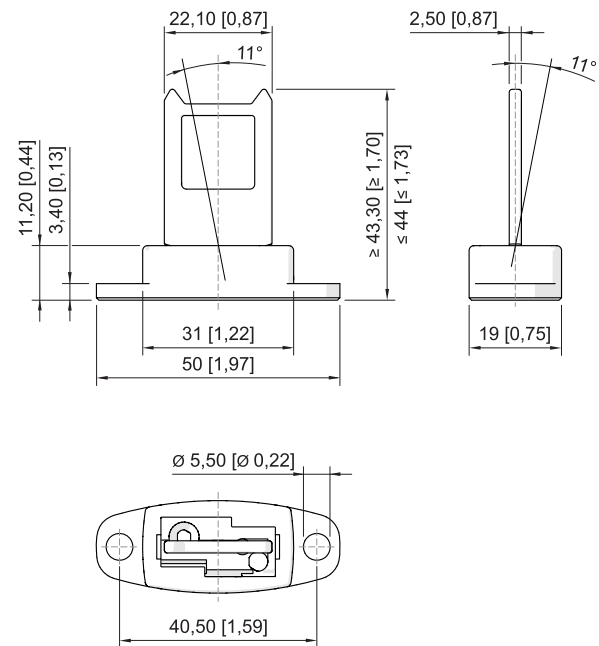

18930E00

Betätiger für Sicherheitsschalter abgewinkelt

Betätiger für Sicherheitsschalter beweglich

7.2 Montage / Demontage, Gebrauchslage

7.2.1 Übersicht Betätiger

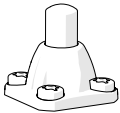
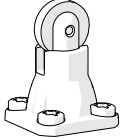
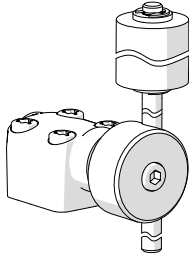
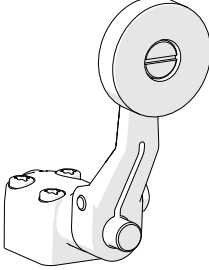
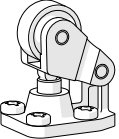
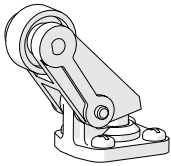
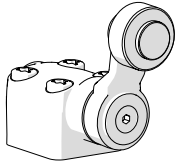
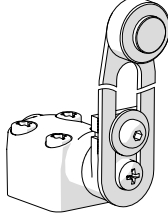
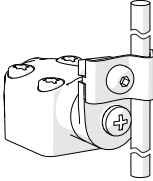
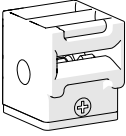
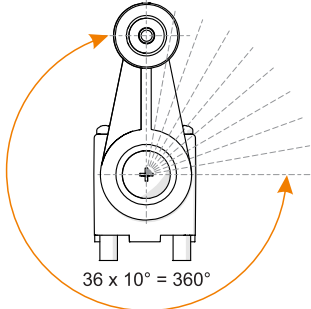
 <p>Stößel 8074/2.-W-40</p> <p>18920E00</p>	 <p>Rollenstößel 8074/2.-R-40</p> <p>18917E00</p>	 <p>Schiefelaufscher 8074/2.-SR-40</p> <p>18918E00</p>	 <p>Langer Drehhebel 8074/2.-DL-40</p> <p>18915E00</p>	 <p>Rollenhebel 8074/2.-WH-40</p> <p>18921E00</p>
 <p>Parallelhebel 8074/2.-WPH-40</p> <p>18922E00</p>	 <p>Drehhebel 8074/2.-D-40</p> <p>18913E00</p>	 <p>Einstellbarer Drehhebel 8074/2.-DS-40</p> <p>18916E00</p>	 <p>Draht-Drehhebel 8074/2.-DD-40</p> <p>18914E00</p>	 <p>Sicherheitsschalter 8074/2.-AZ-20</p> <p>18912E00</p>
 <p>Schwenkbereich</p> <p>18538E00</p>				

7.2.2 Montage Betätiger

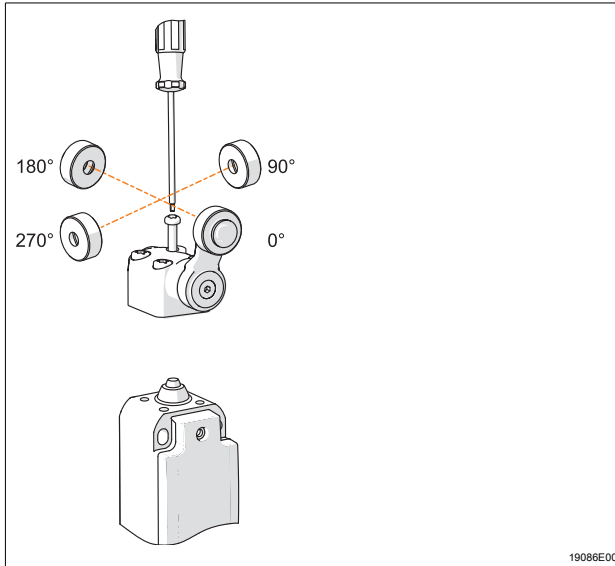

- Betätiger auf den Endschalter in der gewünschten Position aufsetzen. Drehbar in 4 x 90° frei wählbar.
- Betätiger mit vier Schrauben und einem Drehmoment von 1 ... 1,5 Nm anziehen (Schraubendreher Torx T20 verwenden).

7.2.3 Wandmontage

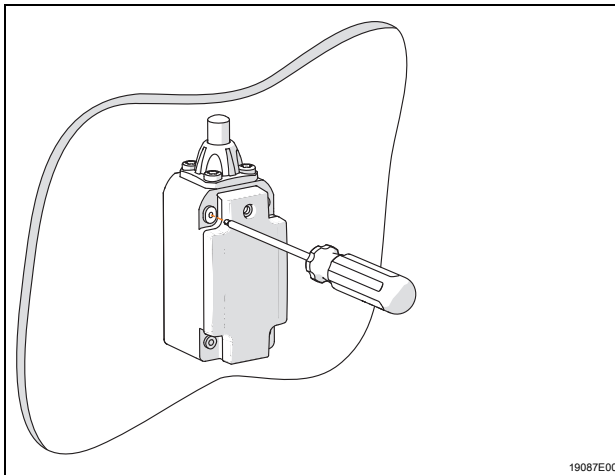

- Positionsschaltergehäuse mit einem Drehmoment von 1,3 ... 1,8 Nm an einem geeigneten Ort montieren.
- Gerät sorgfältig und nur unter Beachtung der Sicherheitshinweise montieren.
- Gerät verwindungsfrei nur auf ebenem Untergrund montieren.

7.3 Installation

	<p style="text-align: center;">GEFAHR</p> <p>Explosionsgefahr durch unzulässige Installation oder Betätigung! Nichtbeachten führt zu schweren oder tödlichen Verletzungen.</p> <ul style="list-style-type: none"> • Positionsschalter nicht als mechanischen Anschlag einsetzen. • Bei Einsatz mit Sicherheitsfunktion gegen Lageänderung sichern.
	<p>Bei Betrieb unter erschwerten Bedingungen wie insbesondere auf Schiffen sind zusätzliche Maßnahmen zur korrekten Installation je nach Einsatzort zu treffen. Weitere Informationen und Anweisungen hierzu erhalten Sie gerne auf Anfrage von Ihrem zuständigen Vertriebskontakt.</p>

7.3.1 Netzanschluss

	<p>Werden Aderendhülsen verwendet, müssen diese unbedingt gasdicht und mit einem geeigneten Werkzeug aufgebracht werden.</p>
---	--

- Der Leiteranschluss ist mit besonderer Sorgfalt durchzuführen.
- Die Leiterisolation muss bis an die Klemme heranreichen. Beim Abisolieren darf der Leiter selbst nicht beschädigt (eingekerbt) werden.
- Durch eine geeignete Auswahl der verwendeten Leitungen sowie durch die Art der Verlegung ist sicherzustellen, dass die maximal zulässigen Leitertemperaturen nicht überschritten werden.
- Angaben zu den Klemmen sind zu beachten (siehe "Technische Daten").

7.3.2 Vorsicherung

Für den Kurzschlusschutz ist eine Vorsicherung mit max. 10 A der Auslösecharakteristik gL/gG gemäß IEC 60269-1 zulässig.

7.3.3 Anschluss Sprungschaltung (bei 8074/2-2-...)

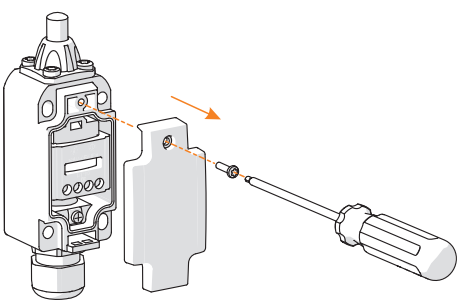
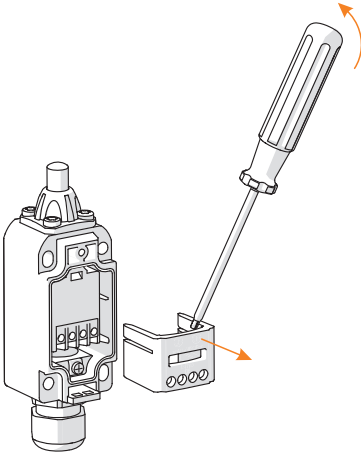
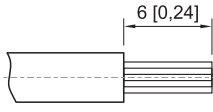
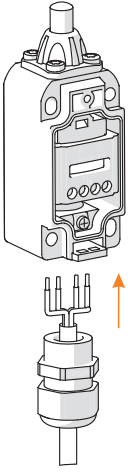
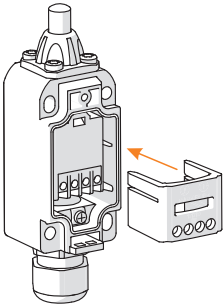
 <p style="text-align: right; font-size: small;">19021E00</p>	<ul style="list-style-type: none"> • Gehäusedeckelschraube lösen (Schraubendreher Torx T10 verwenden). • Gehäusedeckel abnehmen.
 <p style="text-align: right; font-size: small;">19022E00</p>	<ul style="list-style-type: none"> • Einsatz herausnehmen (z.B. mit einem Schraubendreher).
 <p style="text-align: right; font-size: small;">18599E00</p>	<ul style="list-style-type: none"> • Anschlussleitung 6 mm abisolieren. • Leiter beim Abisolieren nicht beschädigen.
 <p style="text-align: right; font-size: small;">19023E00</p>	<ul style="list-style-type: none"> • Anschlussleitung mit einem Drehmoment von 0,4 Nm an den Klemmen am Kontaktblock anschließen. • Isolation der Anschlussleitung bis zur Klemmstelle herantführen.
 <p style="text-align: right; font-size: small;">19024E00</p>	<ul style="list-style-type: none"> • Einsatz in das Gehäuse stecken.

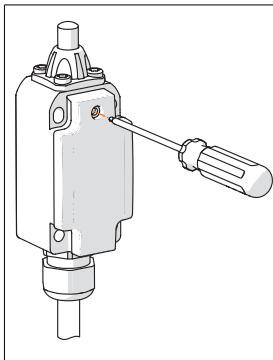

19016E00

- Gehäuse mit Gehäusedeckel verschließen.
- Gehäusedeckel mit einem Drehmoment von 1,5 ... 2 Nm verschrauben (Schraubendreher Torx T10 verwenden).

7.3.4 Anschluss Schleisschaltung

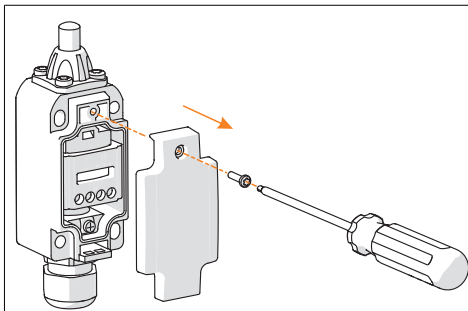

19021E00

- Gehäusedeckelschraube lösen (Schraubendreher Torx T10 verwenden).
- Gehäusedeckel abnehmen.

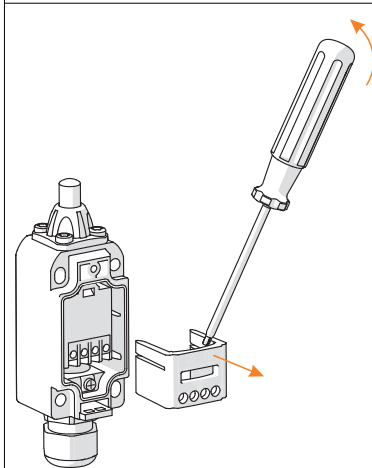

19022E00

- Einsatz herausnehmen (z.B. mit einem Schraubendreher).

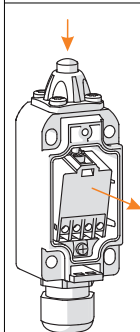

19017E00

- Betätiger drücken und gleichzeitig Kontaktblock nach außen kippen.

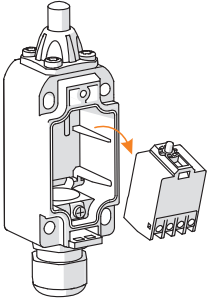
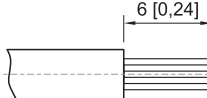
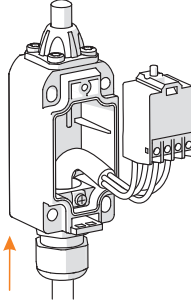
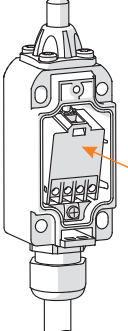
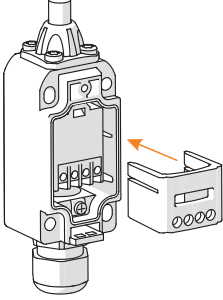
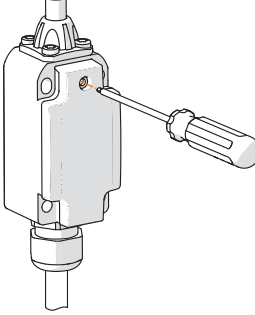
 <p style="text-align: right;">19018E00</p>	<ul style="list-style-type: none"> • Kontaktblock herausnehmen.
 <p style="text-align: right;">18599E00</p>	<ul style="list-style-type: none"> • Anschlussleitung 6 mm abisolieren. • Leiter beim Abisolieren nicht beschädigen.
 <p style="text-align: right;">19019E00</p>	<ul style="list-style-type: none"> • Anschlussleitung mit einem Drehmoment von 0,4 Nm an den Klemmen am Kontaktblock anschließen. • Isolation der Anschlussleitung bis zur Klemmstelle herantführen.
 <p style="text-align: right;">19020E00</p>	<ul style="list-style-type: none"> • Kontaktblock in das Gehäuse einsetzen.
 <p style="text-align: right;">19024E00</p>	<ul style="list-style-type: none"> • Einsatz in das Gehäuse stecken.
 <p style="text-align: right;">19016E00</p>	<ul style="list-style-type: none"> • Gehäuse mit Gehäusedeckel verschließen. • Gehäusedeckel mit einem Drehmoment von 1,5 ... 2 Nm verschrauben (Schraubendreher Torx T10 verwenden).

7.3.5 Montage Leitungseinführungen

	Montage der Leitungseinführungen siehe beigefügte Kurzanleitung.
---	--

8 Inbetriebnahme

	GEFAHR
	<p>Explosionsgefahr durch fehlerhafte Installation! Nichtbeachten führt zu schweren oder tödlichen Verletzungen.</p> <ul style="list-style-type: none"> • Gerät vor der Inbetriebnahme auf korrekte Installation prüfen. • Nationale Bestimmungen einhalten.

Vor Inbetriebnahme Folgendes sicherstellen:

- Kontrollieren, ob Gehäuse beschädigt ist.
- Kontrollieren, ob Teile der druckfesten Kapselung beschädigt sind.
- Gegebenenfalls Fremdkörper entfernen.
- Gegebenenfalls Anschlussraum säubern.
- Kontrollieren, ob Leitungen ordnungsgemäß eingeführt wurden.
- Kontrollieren, ob Leitungen / Adern ordnungsgemäß verlegt wurden.
- Kontrollieren, ob alle Schrauben und Muttern fest angezogen sind.
- Kontrollieren, ob alle Leitungseinführungen und Verschlussstopfen fest angezogen sind.

9 Instandhaltung, Wartung, Reparatur



9.1 Instandhaltung

- Art und Umfang der Prüfungen den entsprechenden nationalen Vorschriften entnehmen.
- Prüfungsintervalle an Betriebsbedingungen anpassen.

Bei der Instandhaltung des Geräts mindestens folgende Punkte prüfen:

- Festen Sitz der Leitungen,
- Einhaltung der zulässigen Temperaturen (gemäß IEC/EN 60079),
- Beschädigungen am Gehäuse und an den Dichtungen.

9.2 Wartung

	GEFAHR
	<p>Überhitzungs- und Explosionsgefahr durch defekte Schaltkontakte! Nichtbeachten führt zu schweren oder tödlichen Verletzungen.</p> <ul style="list-style-type: none"> • Nach jedem Kurzschluss im Hauptstromkreis den Schalter austauschen, da der Zustand der Schaltkontakte bei hermetisch abgeschlossenen Betriebsmitteln nicht überprüft werden kann.
	Die geltenden nationalen Bestimmungen im Einsatzland beachten.

9.3 Reparatur

	GEFAHR
	<p>Explosionsgefahr durch unsachgemäße Reparatur! Nichtbeachten führt zu schweren oder tödlichen Verletzungen.</p> <ul style="list-style-type: none"> • Reparaturen an den Geräten ausschließlich durch R. STAHL Schaltgeräte GmbH ausführen lassen.

9.4 Rücksendung

- Rücksendung bzw. Verpackung der Geräte nur in Absprache mit R. STAHL durchführen! Dazu mit der zuständigen Vertretung von R. STAHL Kontakt aufnehmen.

Für die Rücksendung im Reparatur- bzw. Servicefall steht der Kundenservice von R. STAHL zur Verfügung.

- Kundenservice persönlich kontaktieren.

oder

- Internetseite r-stahl.com aufrufen.
- Unter "Support" > "RMA Formular" > "RMA-Schein anfordern" wählen.
- Formular ausfüllen und absenden.
Sie erhalten per E-Mail automatisch einen RMA-Schein zugeschickt.
Bitte drucken Sie diese Datei aus.
- Gerät zusammen mit dem RMA-Schein in der Verpackung an die R. STAHL Schaltgeräte GmbH senden (Adresse siehe Kapitel 1.1).

10 Reinigung

- Zur Vermeidung elektrostatischer Aufladung dürfen die Geräte in explosionsgefährdeten Bereichen nur mit einem feuchten Tuch gereinigt werden.
- Bei feuchter Reinigung: Wasser oder milde, nicht scheuernde, nicht kratzende Reinigungsmittel verwenden.
- Keine aggressiven Reinigungsmittel oder Lösungsmittel verwenden.

11 Entsorgung

- Nationale und lokal gültige Vorschriften und gesetzliche Bestimmungen zur Entsorgung beachten.
- Materialien getrennt dem Recycling zuführen.
- Umweltgerechte Entsorgung aller Bauteile gemäß den gesetzlichen Bestimmungen sicherstellen.

12 Zubehör und Ersatzteile

HINWEIS

Fehlfunktion oder Geräteschaden durch den Einsatz nicht originaler Bauteile.
Nichtbeachten kann Sachschaden verursachen!

- Nur Original-Zubehör und Original-Ersatzteile der R. STAHL Schaltgeräte GmbH verwenden.



Zubehör und Ersatzteile, siehe Datenblatt auf Homepage r-stahl.com.



Position Switches

Series 8074/2



Contents

1	General Information	3
1.1	Manufacturer	3
1.2	Information about the Manual	3
1.3	Further Documents	3
1.4	Conformity with Standards and Regulations	3
2	Explanation of the Symbols	4
2.1	Symbols in this Manual	4
2.2	Warning Notes	4
2.3	Symbols on the Device	5
3	Safety Notes	5
3.1	Storage of the Manual	5
3.2	Personnel Qualification	5
3.3	Safe Use	6
3.4	Modifications and Alterations	6
4	Function and Device Design	7
4.1	Function	7
5	Technical Data	8
6	Transport and Storage	21
7	Mounting and Installation	21
7.1	Dimensions / Fastening Dimensions	22
7.2	Mounting / Dismounting, Operating Position	23
7.3	Installation	25
8	Commissioning	29
9	Maintenance, Overhaul, Repair	29
9.1	Maintenance	29
9.2	Overhaul	30
9.3	Repair	30
9.4	Returning the Device	30
10	Cleaning	31
11	Disposal	31
12	Accessories and Spare Parts	31

1 General Information

1.1 Manufacturer

R. STAHL Schaltgeräte GmbH
Am Bahnhof 30
74638 Waldenburg
Germany

Phone: +49 7942 943-0
Fax: +49 7942 943-4333
Internet: r-stahl.com
E-Mail: info@stahl.de

1.2 Information about the Manual

ID-No.: 257036 / 807460300070
Publication Code: 2019-10-25-HB00-III-en-03

The original instructions are the English edition.
They are legally binding in all legal affairs.

1.3 Further Documents

- Data sheet
- Operating instructions

For documents in further languages, see r-stahl.com.

1.4 Conformity with Standards and Regulations

See certificates and EU Declaration of Conformity: r-stahl.com.

The device has IECEx approval. For certificate please refer to the IECEx homepage:
<http://iecex.iec.ch/>

Further national certificates can be downloaded via the following link:
<https://r-stahl.com/en/global/support/downloads/>.

EN 2 Explanation of the Symbols

2.1 Symbols in this Manual

Symbol	Meaning
	Tips and recommendations on the use of the device
	Danger due to explosive atmosphere
	Danger due to live components





2.2 Warning Notes

Warnings must be observed under all circumstances, in order to minimize the risk due to construction and operation. The warning notes have the following structure:

- Signalling word: DANGER, WARNING, CAUTION, NOTICE
- Type and source of danger/damage
- Consequences of danger
- Taking countermeasures to avoid the danger or damage

	DANGER
	Danger to persons Non-compliance with the instruction results in severe or fatal injuries to persons.
	WARNING
	Danger to persons Non-compliance with the instruction can result in severe or fatal injuries to persons.
	CAUTION
	Danger to persons Non-compliance with the instruction can result in light injuries to persons.
NOTICE	
Avoiding material damage Non-compliance with the instruction can result in material damage to the device and / or its environment.	

2.3 Symbols on the Device

Symbol	Meaning
 0158 0594E00	CE marking according to the current applicable directive.
 02198E00	According to its marking, the device is certified for hazardous areas.
 15649E00	Input
 15648E00	Output
 11048E00	Safety instructions that must always be observed: For devices with this symbol, the corresponding data and/or the safety-relevant instructions contained in this manual must be observed!

3 Safety Notes

3.1 Storage of the Manual

- Read the manual carefully.
- Store the manual at the mounting location of the device.
- Observe applicable documents and operating instructions of the devices to be connected.

3.2 Personnel Qualification

Qualified specialist personnel are required to perform the tasks described in this manual. This primarily applies to work in the following areas:

- Project engineering
- Mounting/dismounting the device
- (Electrical) installation
- Commissioning
- Maintenance, repair, cleaning

Specialists who perform these tasks must have a level of knowledge that meets applicable national standards and regulations.

Additional knowledge is required for tasks in hazardous areas! R. STAHL recommends having a level of knowledge equal to that described in the following standards:

- IEC/EN 60079-14 (Electrical installations design, selection and construction)
- IEC/EN 60079-17 (Inspection and maintenance of electrical installations)
- IEC/EN 60079-19 (Equipment repair, overhaul and reclamation)

3.3 Safe Use

Before mounting

- Read and observe the safety notes in this manual.
- Ensure that the contents of this manual are fully understood by the personnel in charge.
- Use the device in accordance with its intended and approved purpose only.
- Always consult with R. STAHL Schaltgeräte GmbH if using the device under operating conditions not covered by the technical data.
- Make sure that the device is not damaged.
- We are not liable for damage caused by incorrect or unauthorised use of the device or by non-compliance with this manual.



For mounting and installation

- Have mounting and installation performed only by qualified and authorised persons (see chapter "Qualification of the personnel").
- The device is only to be installed in areas for which it is suited based on its marking.
- During installation and operation, observe the information (characteristic values and rated operating conditions) on the rating, data and information plates located on the device.
- Before installation, make sure that the device is not damaged.

Commissioning, maintenance, repair

- Only have commissioning and repairs performed by qualified and authorised persons (see chapter "Personnel qualification").
- Before commissioning, make sure that the device is not damaged.
- Perform only maintenance work described in this manual.
- The device must not be operated if there are dust deposits that are 50 mm thick, as stated in IEC/EN 61241-0.

3.4 Modifications and Alterations

	DANGER
	<p>Explosion hazard due to modifications and alterations to the device! Non-compliance results in severe or fatal injuries.</p> <ul style="list-style-type: none"> • Do not modify or alter the device.
	<p>No liability or warranty for damage resulting from modifications and alterations.</p>

4 Function and Device Design

	DANGER
	<p>Explosion hazard due to improper use! Non-compliance results in severe or fatal injuries.</p> <ul style="list-style-type: none"> • Use the device only in accordance with the operating conditions described in this manual. • Use the device only for the intended purpose specified in this manual.

4.1 Function

Application range

Position switches position, control and monitor moving parts on machines and systems. Because they meet the requirements of the EN 50 041 and IEC 60947-5-1 product standards, they can also be used as a position switch with a safety function. Series 8074/2 position switches are certified for use in hazardous areas of Zones 1, 2, 21 and 22.

Mode of operation

In conjunction with a guard door monitor and the corresponding circuitry, the PL position switches reach "e" in accordance with EN ISO 13849-1, or up to SIL 3 in accordance with EN 62061.

They are identified with the \ominus character for positive opening operation.

There are snap and slow action versions in different forms of contacts as well as in a variety of different actuating elements.

5 Technical Data

Explosion Protection

Global (IECEX)

Gas and dust	IECEX BVS 16.0085 Ex d e IIC T6 ... T5 Gb Ex tb IIIC T80°C Db
--------------	---

Europe (ATEX)

Gas and dust	BVS 05 ATEX E 007 ⊕ II 2 G Ex d e IIC T6 ... T5 Gb ⊕ II 2 D Ex tb IIIC T80°C Db
--------------	---

Certifications and certificates

Certificates	IECEX, ATEX, further see r-stahl.com
--------------	--------------------------------------

Technical Data

Version	8074/2-.-W, -R, -SR, -DL, -WH, -WPH, -D, -DS, -DD
---------	---

Electrical data

Rated operational voltage U_e			8074/2-1 8074/2-2 8074/2-5	8074/2-3
	Alternating voltage for equal potential: Alternating voltage for unequal potential: Direct voltage:		max. 500 V max. 250 V 125 V	max. 400 V max. 250 V 125 V
Rated operational current I_e	4.4 A: +70 °C (T6); 6.6 A: +70 °C (T5)			
Switching capacity	AC-12		AC-15	
	8074/2-1 8074/2-2 8074/2-5	8074/2-3	8074/2-1 8074/2-2 8074/2-5	8074/2-3 8074/2-.
	max. 250 V max. 500 V **) max. 4 A max. 5000 VA	max. 250 V max. 400 V **) max. 4 A max. 4000 VA	max. 250 V max. 500 V **) max. 4 A max. 1000 VA	max. 250 V max. 400 V **) max. 4 A max. 1000 VA
**) only with the same potential				
Rated insulation voltage	250 V			
Rated impulse withstand voltage	4 kV			
Short circuit protection	10 A gG			
Ambient conditions				
Operating temperature range	-40 to +70 °C, T6 (max. 4.4 A) -40 to +70 °C, T5 (max. 6.6 A)			

Technical Data

Version	8074/2-.-AZ-20	
Electrical data		
Rated operational voltage U_e	8074/2-.-AZ-20	
	Alternating voltage:	250 V AC
	Direct voltage:	230 V DC
Rated operational current I_e	max. 6 A: $-20\text{ °C} < T_a < +60\text{ °C}$, 250 V AC; max. 0.25 A: $-20\text{ °C} < T_a < +60\text{ °C}$, 230 V DC	
Switching capacity	AC-15	DC-13
	max. 250 V max. 6 A	max. 230 V max. 0.25 A
Rated insulation voltage	250 V	
Rated impulse withstand voltage	4 kV	
Short circuit protection	10 A gG	
Ambient conditions		
Operating temperature range	-20 to +40 °C (T6)	
	-20 to +60 °C (T5)	

Technical Data

Version	8074/2-.-W, -R, -SR, -DL, -WH, -WPH, -D, -DS, -DD, -AZ-20	
Mechanical data		
Maximum switching frequency	max. 1800 operating cycles/h	
Degree of protection	IP66 -40 °C (DIN EN 60529)	
Mechanical shock resistance	Snap-action contact:	2 g
	Slow-action contact:	20 g
Material		
Enclosure	Corrosion-resistant aluminium, powder-coated Similar to RAL 7016	
Cover	1.4401 stainless steel, blasted	
Mounting / Installation		
Cable entries	8161/7-M20.. on the enclosure bottom: 1 x M20 x 1.5	
Connection	with cable entry 8161: For sheathed cable 4 x 2.5 mm ² (Ø 4 to 13 mm); 4 x 1.5 mm ² recommended	
Terminals	0.75 to 2.5 mm ² , 0.75 to 1.5 mm ² (8074/2-.-AZ-20) solid, finely stranded with or without core end sleeve; additional outer protective conductor connection up to max. 4 mm ²	
Tightening torque	Screw terminals:	0.4 Nm max.
	Cover screws:	1.5 to 2 Nm
	Cable entries:	See installation note (enclosed unattached)

Technical Data

Contact

Version

Slow-action contact

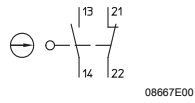

8074/2-1

08667E00

Snap-action contact

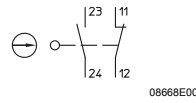

8074/2-2

08668E00

Slow-action contact, overlapping

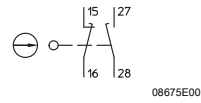

8074/2-5

08675E00

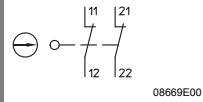

8074/2-3

08669E00

Caution:

The positive opening operation \ominus function depends on the actuator

Contact arrangement

2-pole, galvanically separated with double break

Contact opening

≥ 1.5 mm (isolating distance ≥ 3 mm)

Material

Contacts

Silver-nickel

Enclosure contact

Polyamide, glass fibre reinforced

Service life

Mechanical

max. 10^6 operating cycles

electrical

max. 10^6 operating cycles

Technical data

Operation, operating speed, switching travel or switching angle

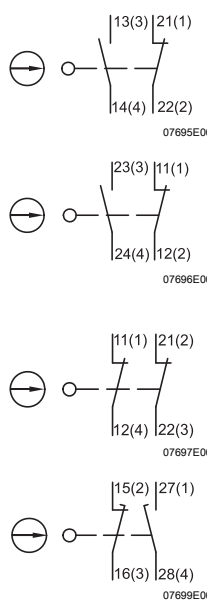
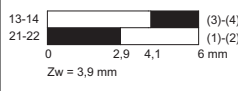
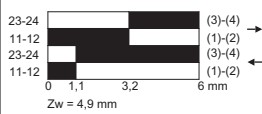
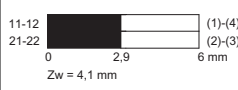
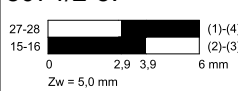
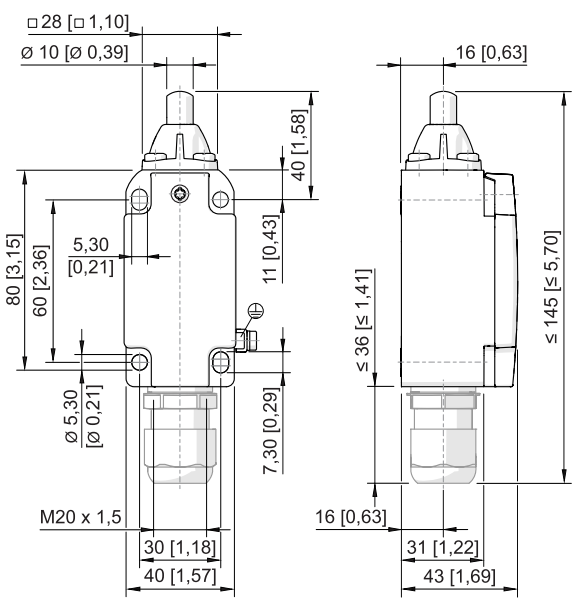
Actuator type	Actuation	Schematic	Nominal switching travel or switching angle	Minimum force/torque
Type 8074/2	V = Max. operating speed	⊕ = Positive opening operation	■ = Closed contact □ = Open contact Zw = Positive opening distance	
Plunger 8074/2.-W-40	For lateral actuation: V = 0.5 m/s Actuation in stroke direction: V = 1.0 m/s		In stroke direction 8074/2-1:  8074/2-2:  8074/2-3:  8074/2-5: 	22 N
		18822E00		

Technical data

Operation, operating speed, switching travel or switching angle

Actuator type	Actuation	Schematic	Nominal switching travel or switching angle	Minimum force/torque
Type 8074/2	V = Max. operating speed	⊕ = Positive opening operation	■ = Closed contact □ = Open contact Zw = Positive opening distance	
Roller plunger 8074/2.-R-40	For lateral actuation: V = 1.0 m/s Actuation in stroke direction: V = 1.0 m/s		In stroke direction 8074/2-1: 13-14 (3)-(4) 21-22 (1)-(2) Zw = 3,9 mm 18999E00 8074/2-2: 23-24 (3)-(4) 11-12 (1)-(2) 23-24 (3)-(4) 11-12 (1)-(2) Zw = 4,9 mm 19051E00 8074/2-3: 11-12 (1)-(4) 21-22 (2)-(3) Zw = 4,1 mm 18999E00 8074/2-5: 27-28 (1)-(4) 15-16 (2)-(3) Zw = 5,0 mm 19000E00	22 N
			18820E00	

Technical data

Operation, operating speed, switching travel or switching angle

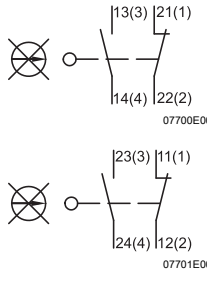
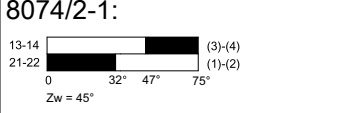
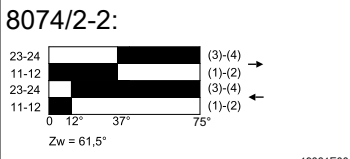
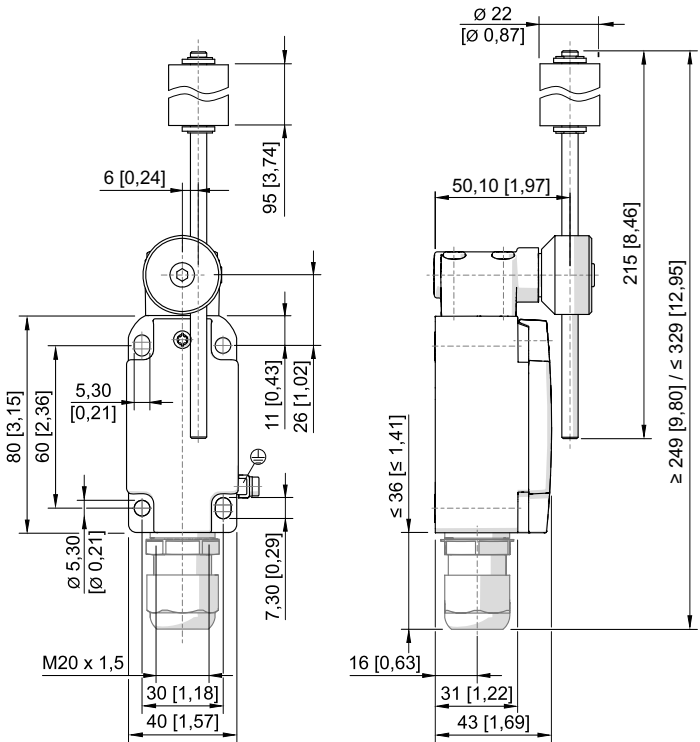
Actuator type	Actuation	Schematic	Nominal switching travel or switching angle	Minimum force/torque
Type 8074/2	V = Max. operating speed	⊕ = Positive opening operation	■ = Closed contact □ = Open contact Zw = Positive opening distance	
Misalignment switch 8074/2-.SR-40	Positive opening operation, not suitable for safety circuits		<p>8074/2-1:</p>  <p>8074/2-2:</p> 	2.5 N
				

18821E00

Technical data

Operation, operating speed, switching travel or switching angle

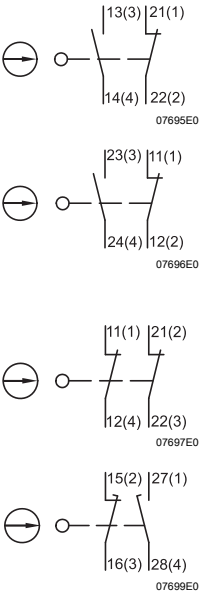
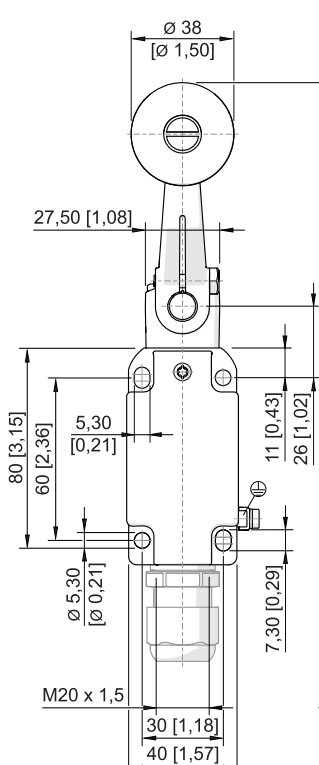
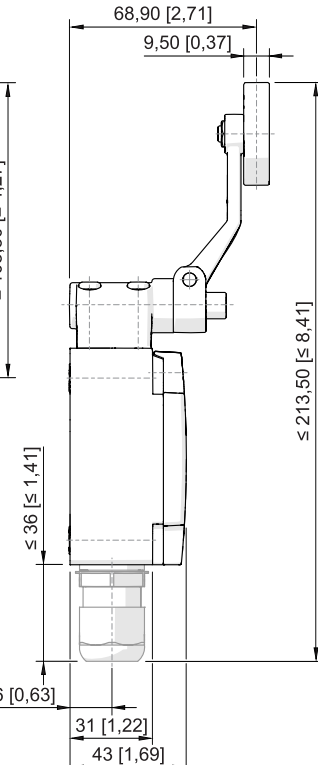
Actuator type	Actuation	Schematic	Nominal switching travel or switching angle	Minimum force/torque
Type 8074/2	V = Max. operating speed	⊕ = Positive opening operation	■ = Closed contact □ = Open contact Zw = Positive opening distance	
Long rotary lever 8074/2-.DL-40		 <p>8074/2-1: 13-14 (3)-(4) 21-22 (1)-(2) Zw = 45°</p> <p>8074/2-2: 23-24 (3)-(4) 11-12 (1)-(2) 23-24 (3)-(4) 11-12 (1)-(2) Zw = 61,5°</p> <p>8074/2-3: 11-12 (1)-(4) 21-22 (2)-(3) Zw = 47°</p> <p>8074/2-5: 27-28 (1)-(4) 15-16 (2)-(3) Zw = 62°</p>	<p>19060E00</p> <p>19061E00</p> <p>19062E00</p> <p>19064E00</p>	<p>3 N</p>
 <p>Dimensions: $\varnothing 38$ [$\varnothing 1,50$], 27,50 [1,08], $\leq 108,50$ [$\leq 4,27$], 80 [3,15], 60 [2,36], 5,30 [0,21], 11 [0,43], 26 [1,02], $\varnothing 5,30$ [$\varnothing 0,21$], 7,30 [0,29], M20 x 1,5, 30 [1,18], 40 [1,57], ≤ 36 [$\leq 1,41$], 16 [0,63], 31 [1,22], 43 [1,69]</p>		 <p>Dimensions: 68,90 [2,71], 9,50 [0,37], $\leq 213,50$ [$\leq 8,41$]</p>		<p>18818E00</p>

Technical data

Operation, operating speed, switching travel or switching angle

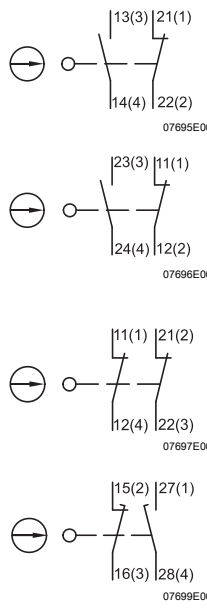
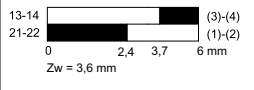
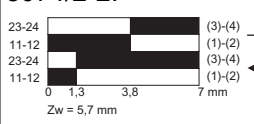
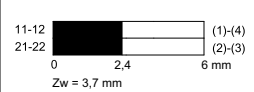
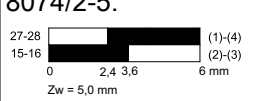
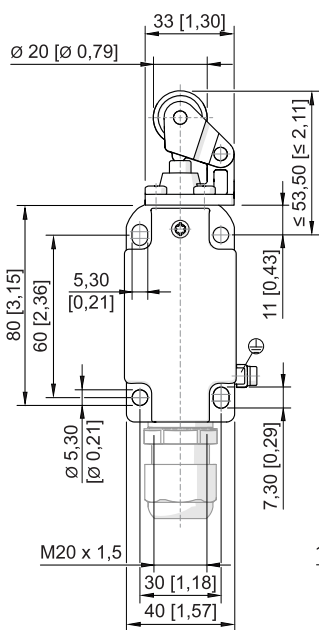
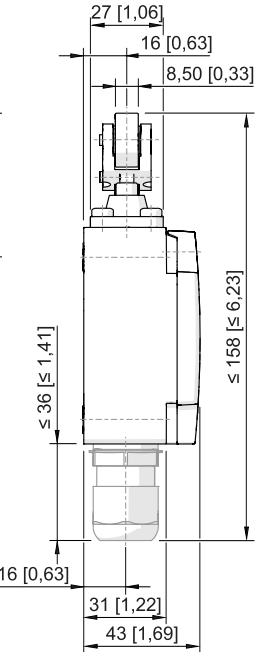
Actuator type	Actuation	Schematic	Nominal switching travel or switching angle	Minimum force/torque
Type 8074/2	V = Max. operating speed	<p>⊕ = Positive opening operation</p>	<p>■ = Closed contact □ = Open contact Zw = Positive opening distance</p>	
Roller lever 8074/2-.-WH-40	V = 1.0 m/s		<p>Displacement of the roller in the stroke direction of the plunger at the start of the plunger movement</p> <p>8074/2-1:</p>  <p>8074/2-2:</p>  <p>8074/2-3:</p>  <p>8074/2-5:</p> 	18 N
				

18823E00

Technical data

Operation, operating speed, switching travel or switching angle

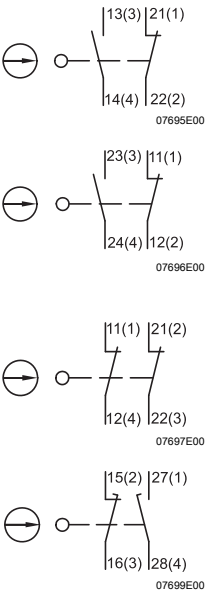
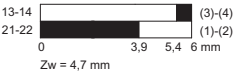
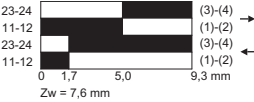
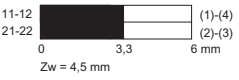
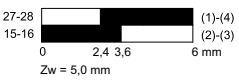
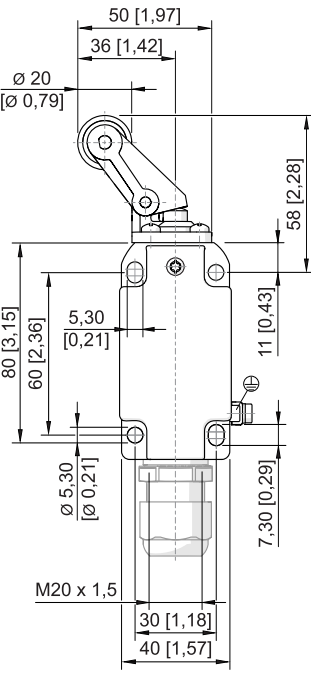
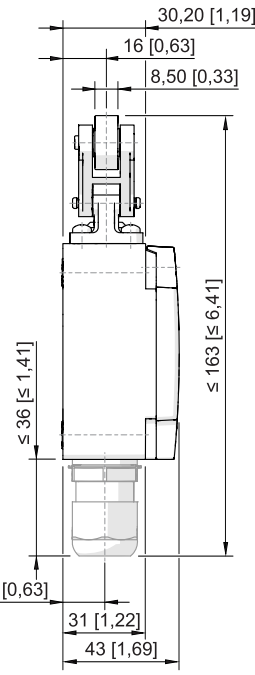
Actuator type	Actuation	Schematic	Nominal switching travel or switching angle	Minimum force/torque
Type 8074/2	V = Max. operating speed	⊕ = Positive opening operation	■ = Closed contact □ = Open contact Zw = Positive opening distance	
Parallel roller lever 8074/2-.-WPH-40	V = 1.0 m/s		Displacement of the roller vertically in the stroke direction of the plunger at the start of the plunger movement 8074/2-1:  19004E00 8074/2-2:  19059E00 8074/2-3:  19005E00 8074/2-5:  19057E00	18 N
				

18824E00



Technical data

Operation, operating speed, switching travel or switching angle

Actuator type	Actuation	Schematic	Nominal switching travel or switching angle	Minimum force/torque
Type 8074/2	V = Max. operating speed	⊕ = Positive opening operation	■ = Closed contact □ = Open contact Zw = Positive opening distance	

Rotary lever
8074/2-.D-40

V = 1.5 m/s

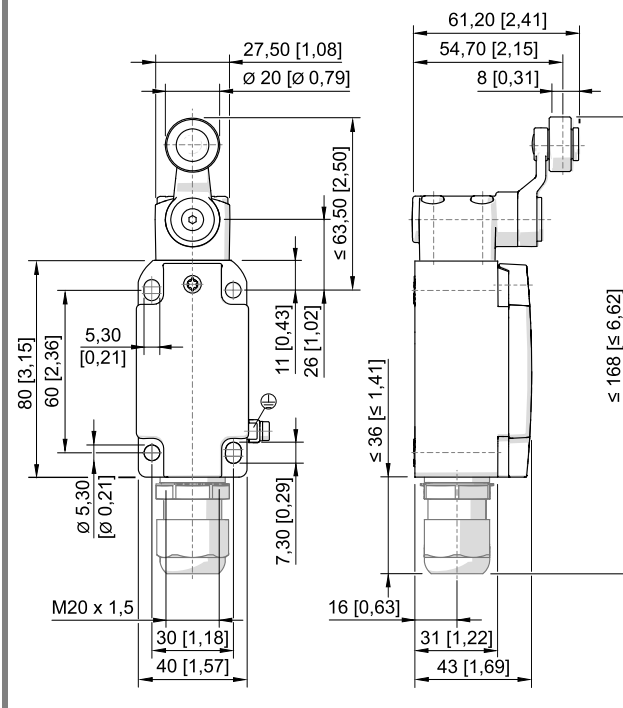
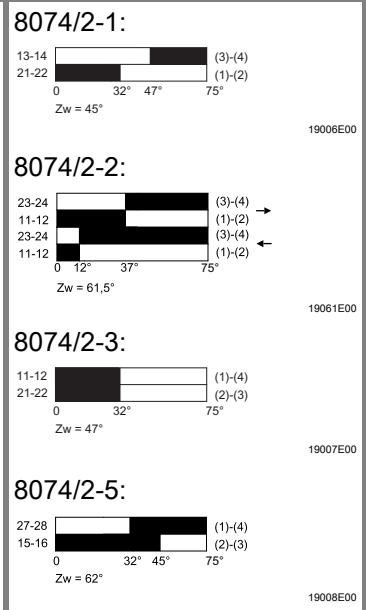
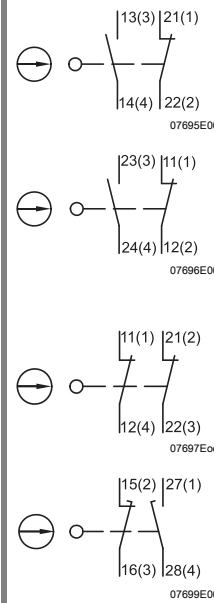

18816E00

Technical data

Operation, operating speed, switching travel or switching angle

Actuator type	Actuation	Schematic	Nominal switching travel or switching angle	Minimum force/torque
Type 8074/2	V = Max. operating speed	⊕ = Positive opening operation	■ = Closed contact □ = Open contact Zw = Positive opening distance	
Adjustable rotary lever 8074/2-.DS-40	V = 1.5 m/s Positive opening operation, not suitable for safety circuits		<p>8074/2-1:</p> <p>8074/2-2:</p> <p>8074/2-3:</p> <p>8074/2-5:</p>	4.5 N

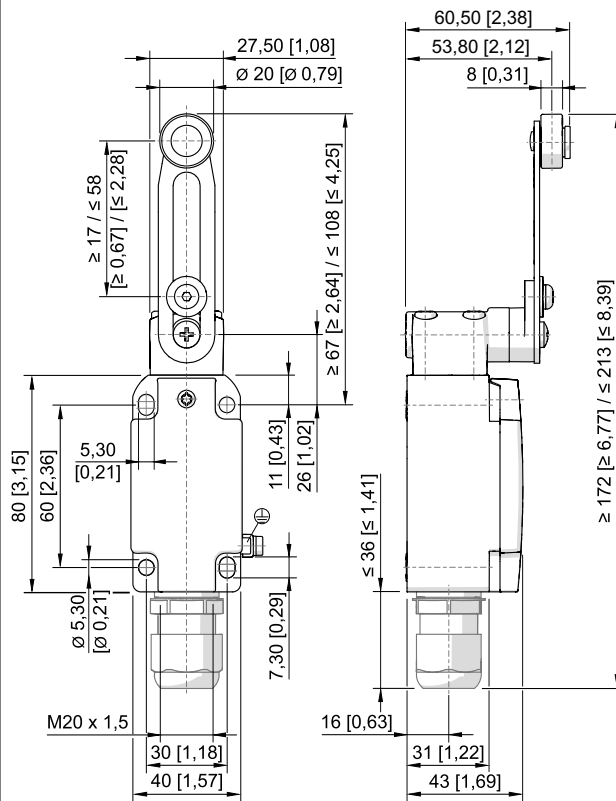

18819E00

Technical data

Operation, operating speed, switching travel or switching angle

Actuator type	Actuation	Schematic	Nominal switching travel or switching angle	Minimum force/torque
Type 8074/2	V = Max. operating speed	⊕ = Positive opening operation	■ = Closed contact □ = Open contact Zw = Positive opening distance	
Rod lever 8074/2-.DD-40	V = 1.5 m/s Positive opening operation, not suitable for safety circuits		<p>8074/2-1:</p> <p>19006E00</p> <p>8074/2-2:</p> <p>19061E00</p> <p>8074/2-3:</p> <p>19007E00</p> <p>8074/2-5:</p> <p>19008E00</p>	2.5 N

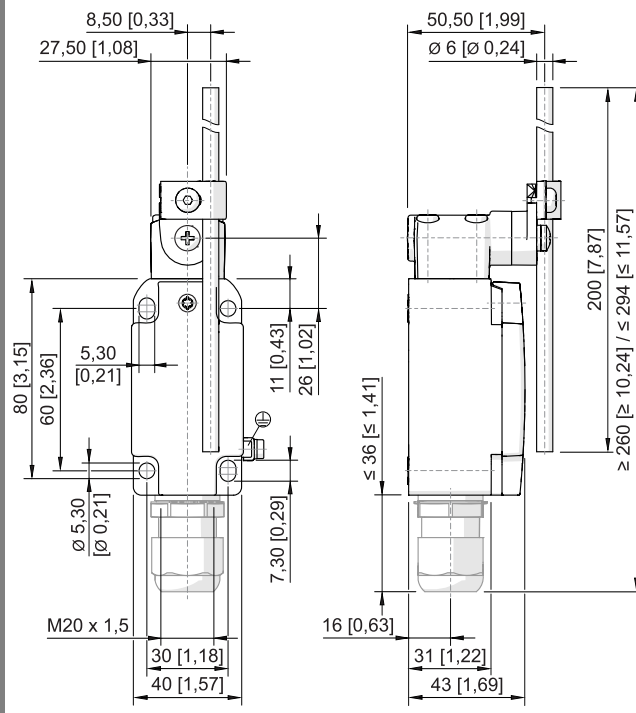

18817E00

Technical data

Operation, operating speed, switching travel or switching angle

Actuator type	Actuation	Schematic	Nominal switching travel or switching angle	Minimum force/torque
Type 8074/2	V = Max. operating speed	⊕ = Positive opening operation	■ = Closed contact □ = Open contact Zw = Positive opening distance	
Safety switch 8074/2-.-AZ-20			8074/2-1: 8074/2-3: 	17 N

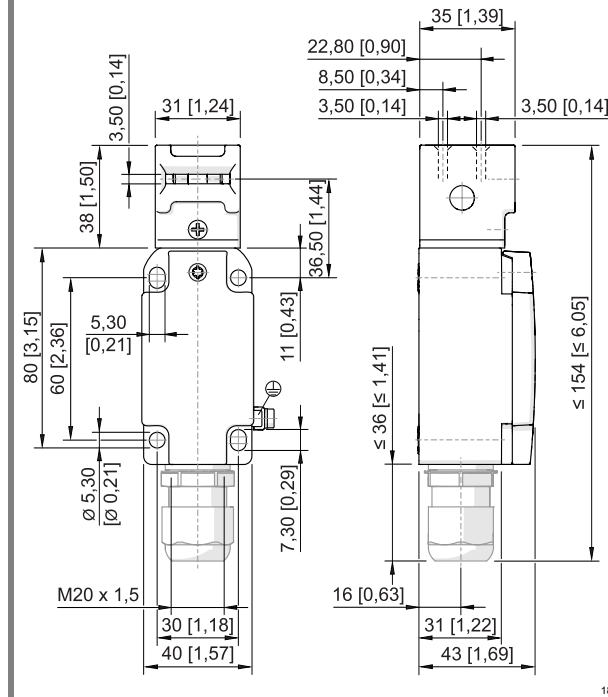

Note:
 Depiction of the switching travel when the actuator is engaged.
 The actuators must be ordered separately.

For further technical data, see r-stahl.com.

6 Transport and Storage

- Transport and store the device only in the original packaging.
- Store the device in a dry place (no condensation) and vibration-free.
- Do not drop the device.

7 Mounting and Installation

The device is approved for use in gas explosion hazardous areas of Zones 1 and 2 and dust explosion hazardous area of Zones 21 and 22 and in safe areas.

DANGER	
	<p>Explosion hazard due to incorrect installation of the device! Non-compliance results in severe or fatal injuries.</p> <ul style="list-style-type: none"> • Carry out installation strictly according to the instructions and national safety and accident prevention regulations to maintain the explosion protection. • Select and install the electrical device so that explosion protection is not affected due to external influences, i.e. pressure conditions, chemical, mechanical, thermal and electric impact such as vibration, humidity and corrosion (see IEC/EN 60079-14). • The device must only be installed by trained qualified personnel who is familiar with the relevant standards.

7.1 Dimensions / Fastening Dimensions

Dimensional drawings (all dimensions in mm [inches]) – Subject to modifications

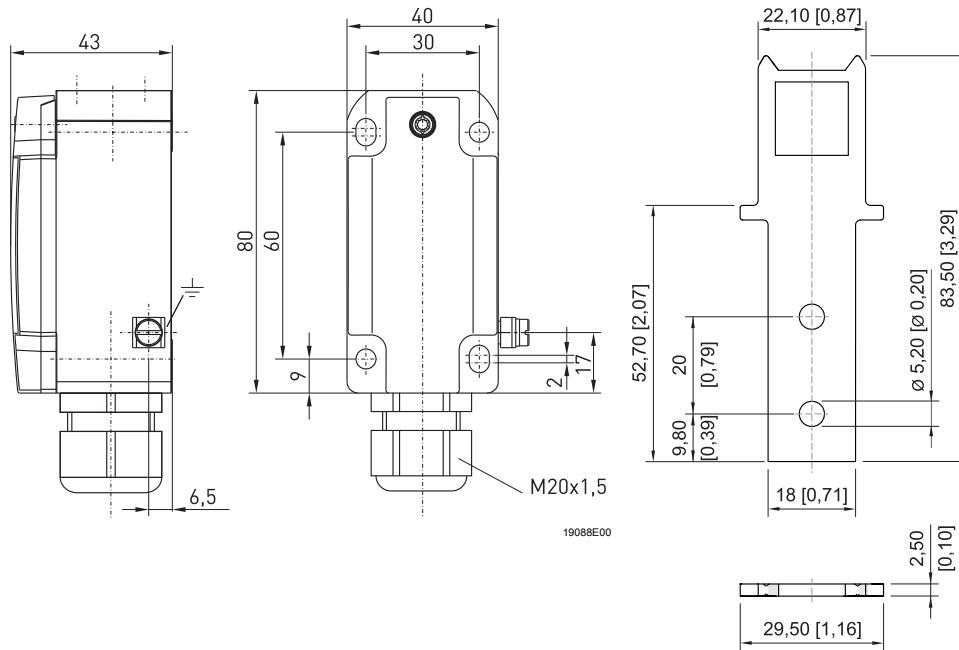

19088E00

18928E00

Position switch 8074/2

Straight actuator for safety switch

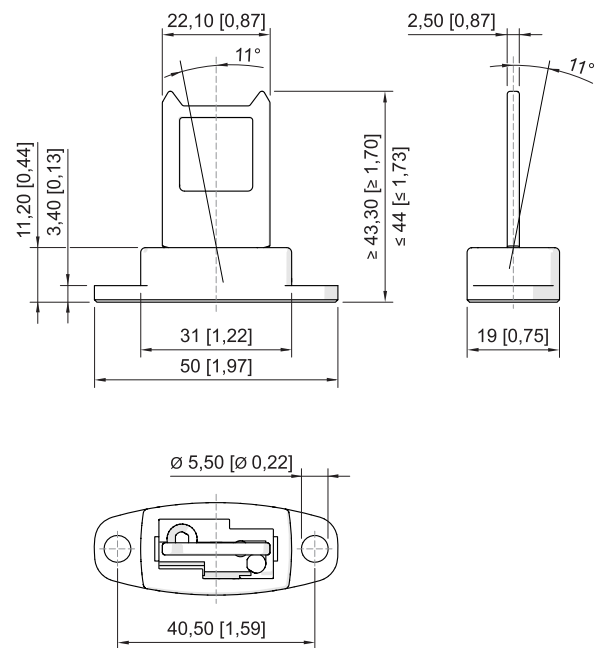
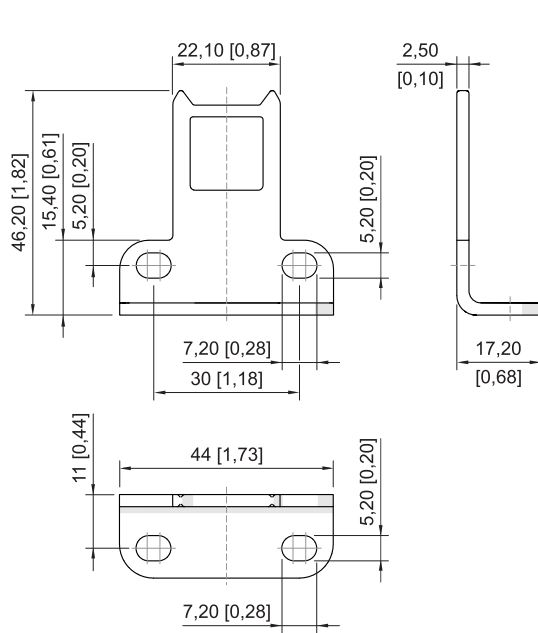

18928E00

18930E00

Bent actuator for safety switch

Movable actuator for safety switch

7.2 Mounting / Dismounting, Operating Position

7.2.1 Actuator Overview

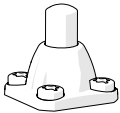
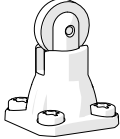
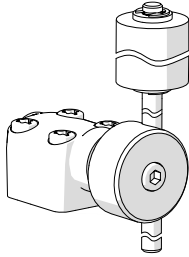
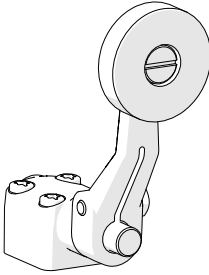
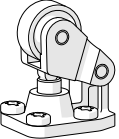
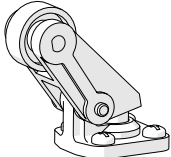
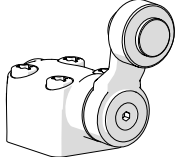
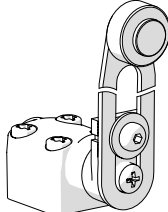
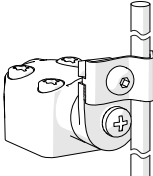
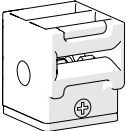
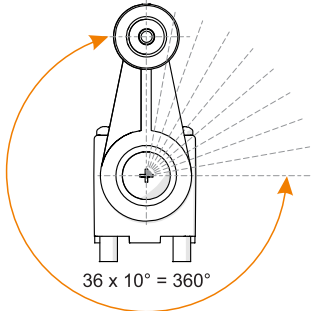
 <p>Plunger 8074/2-.-W-40</p> <p>18920E00</p>	 <p>Roller plunger 8074/2-.-R-40</p> <p>18917E00</p>	 <p>Misalignment switch 8074/2-.-SR-40</p> <p>18918E00</p>	 <p>Long rotary lever 8074/2-.-DL-40</p> <p>18915E00</p>	 <p>Roller lever 8074/2-.-WH-40</p> <p>18921E00</p>
 <p>Parallel roller lever 8074/2-.-WPH-40</p> <p>18922E00</p>	 <p>Rotary lever 8074/2-.-D-40</p> <p>18913E00</p>	 <p>Adjustable rotary lever 8074/2-.-DS-40</p> <p>18916E00</p>	 <p>Rod lever 8074/2-.-DD-40</p> <p>18914E00</p>	 <p>Safety switch 8074/2-.-AZ-20</p> <p>18912E00</p>
 <p>36 x 10° = 360°</p> <p>Slewing range</p> <p>18538E00</p>				

7.2.2 Actuator Assembly

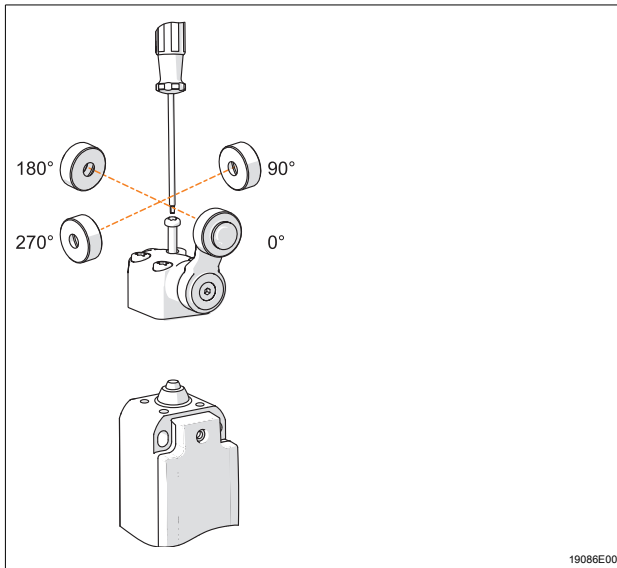

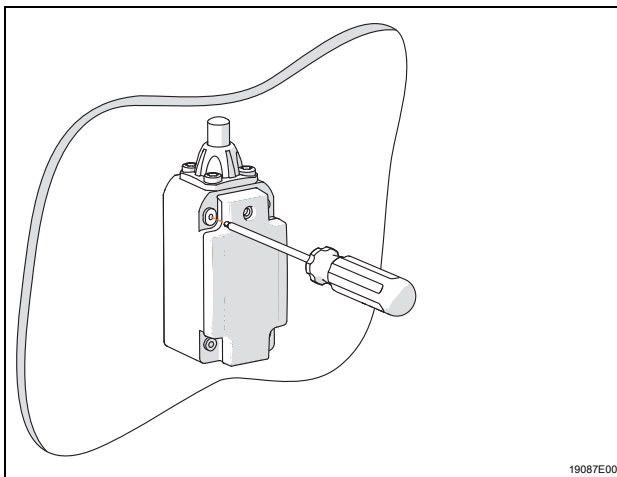

- Place the actuator in the desired position on the end switch. Can be rotated 90° in 4 different ways.
- Tighten the actuator using 4 screws and with a torque of 1 to 1.5 Nm (use a screwdriver Torx T20).

7.2.3 Wall Mounting



- Mount the position switch enclosure in a suitable location with a torque of 1.3 to 1.8 Nm.
- Mount the device carefully and only in accordance with the safety notes.
- Mount the device torsion-free only on a level surface.

7.3 Installation

	<p style="text-align: center;">DANGER</p> <p>Explosion hazard due to improper installation or operation! Non-compliance results in severe or fatal injuries.</p> <ul style="list-style-type: none"> • Do not use position switch as a mechanical stop. • Protect it from changing position when used with a safety function.
	<p>Operation under difficult conditions, such as, in particular, on ships, requires additional measures to be taken for correct installation, depending on the place of use. Further information and instructions on this can be obtained from your regional sales contact on request.</p>

7.3.1 Mains Connection

	<p>If core end sleeves are used, they must be gas-tight and attached using a suitable tool.</p>
---	---

- The conductor must be connected carefully.
- The conductor insulation must reach to the terminal. Do not damage (nick) the conductor when stripping it.
- Ensure that the maximum permissible conductor temperatures are not exceeded by performing a suitable selection of electric lines used and means of running them.
- The specifications for the terminals are to be observed (see "Technical Data").

7.3.2 Back-Up Fuse

A back-up fuse with max. 10 A tripping characteristic gL/gG according to IEC 60269-1 can be used for short-circuit protection.

7.3.3 Snap Switch Connection (for 8074/2-2-...)

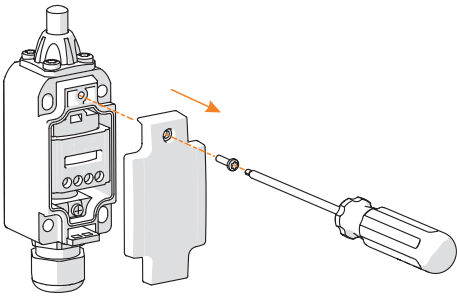
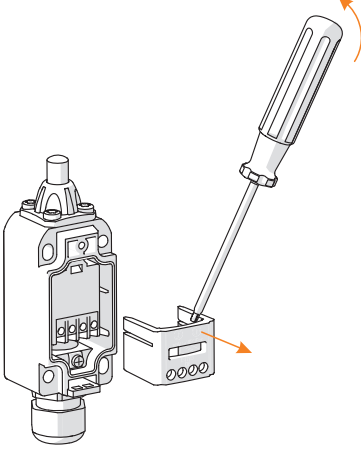
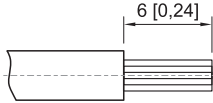
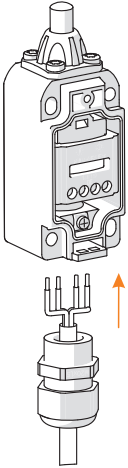
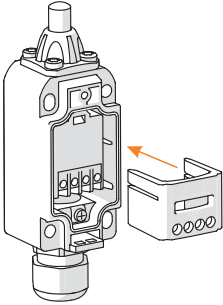
 <p>19021E00</p>	<ul style="list-style-type: none"> • Loosen the enclosure cover screw (use a screwdriver Torx T10). • Remove the enclosure cover.
 <p>19022E00</p>	<ul style="list-style-type: none"> • Remove insert (e.g. using a screwdriver).
 <p>18599E00</p>	<ul style="list-style-type: none"> • Strip the 6 mm connection line. • Do not damage the conductor when removing the insulation.
 <p>19023E00</p>	<ul style="list-style-type: none"> • Connect the connection line to the terminal on the contact block using a torque of 0.4 Nm. • Guide the connection line insulation to the clamping unit.
 <p>19024E00</p>	<ul style="list-style-type: none"> • Insert the insert into the enclosure.

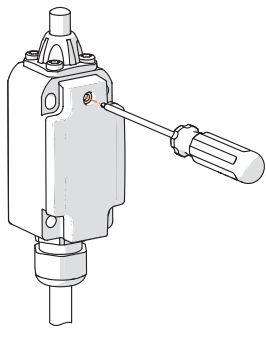
 <p>19016E00</p>	<ul style="list-style-type: none"> • Close the enclosure using the enclosure cover. • Fasten the enclosure cover with a torque of 1.5 to 2 Nm (use a screwdriver Torx T10).
---	---

7.3.4 Slow-Action Circuit Connection

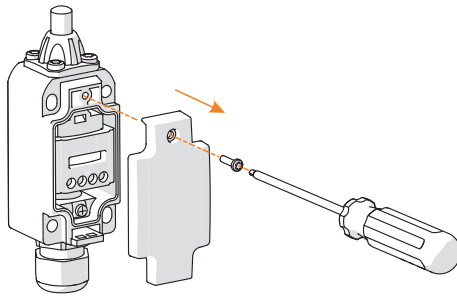
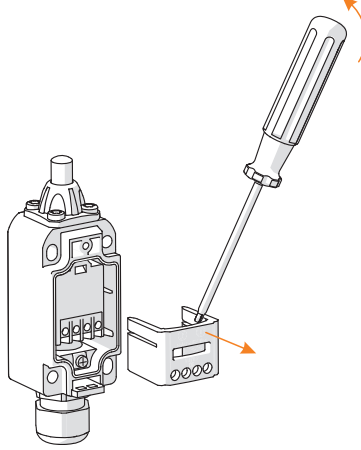
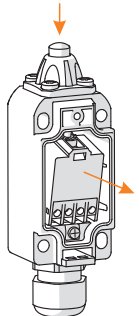
 <p>19021E00</p>	<ul style="list-style-type: none"> • Loosen the enclosure cover screw (use a screwdriver Torx T10). • Remove the enclosure cover.
 <p>19022E00</p>	<ul style="list-style-type: none"> • Remove insert (e.g. using a screwdriver).
 <p>19017E00</p>	<ul style="list-style-type: none"> • Press the actuator and simultaneously tilt the contact block to the outside.

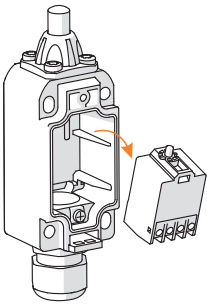
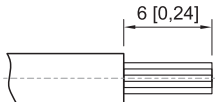
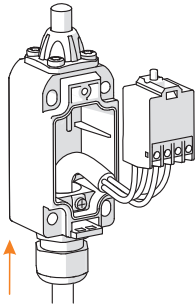
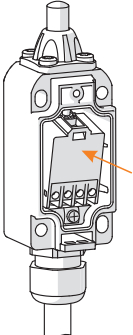
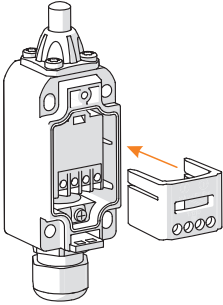
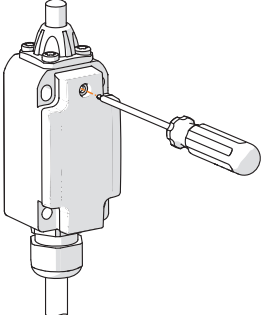
 <p style="text-align: right;">19018E00</p>	<ul style="list-style-type: none"> Remove the contact block.
 <p style="text-align: right;">18599E00</p>	<ul style="list-style-type: none"> Strip the 6 mm connection line. Do not damage the conductor when removing the insulation.
 <p style="text-align: right;">19019E00</p>	<ul style="list-style-type: none"> Connect the connection line to the terminal on the contact block using a torque of 0.4 Nm. Guide the connection line insulation to the clamping unit.
 <p style="text-align: right;">19020E00</p>	<ul style="list-style-type: none"> Insert the contact block into the enclosure.
 <p style="text-align: right;">19024E00</p>	<ul style="list-style-type: none"> Insert the insert into the enclosure.
 <p style="text-align: right;">19016E00</p>	<ul style="list-style-type: none"> Close the enclosure using the enclosure cover. Fasten the enclosure cover with a torque of 1.5 to 2 Nm (use a screwdriver Torx T10).

7.3.5 Cable Entry Assembly

	Cable entry assembly, see Brief Instructions attached.
---	--

8 Commissioning

	DANGER
	<p>Explosion hazard due to incorrect installation! Non-compliance results in severe or fatal injuries.</p> <ul style="list-style-type: none"> • Check the device for proper installation before commissioning. • Comply with national regulations.

Before commissioning, ensure the following:

- Check to see if the enclosure is damaged.
- Check to see if parts of the flameproof enclosure are damaged.
- If necessary, remove foreign bodies.
- If necessary, clean the connection chamber.
- Check if the conductors have been inserted correctly.
- Check to see if the conductors / wires have been installed properly.
- Check if all screws and nuts have been tightened firmly.
- Check whether all the cable entries and stopping plugs have been tightened firmly.

9 Maintenance, Overhaul, Repair



9.1 Maintenance

- Consult the relevant national regulations to determine the type and extent of inspections.
- Adapt inspection intervals according to the operating conditions.

At a minimum, check the following points during maintenance work on the device:

- Firm fit of the conductors,
- Compliance with the permissible temperatures (according to IEC/EN 60079),
- Damage to the enclosure and seals.

9.2 Overhaul

	DANGER
	<p>Overheating and explosion hazard due to defective switching contacts! Non-compliance results in severe or fatal injuries.</p> <ul style="list-style-type: none"> • Replace the switch after each short circuit in the main circuit (the element is hermetically sealed and the state of the switching contacts cannot be checked).
	<p>Observe the relevant national regulations in the country of use.</p>

9.3 Repair

	DANGER
	<p>Explosion hazard due to improper repair! Non-compliance results in severe or fatal injuries.</p> <ul style="list-style-type: none"> • Repair work on the devices must be performed only by R. STAHL Schaltgeräte GmbH.

9.4 Returning the Device

- Only return or package the devices after consulting R. STAHL!
Contact the responsible representative from R. STAHL.

R. STAHL's customer service is available to handle returns if repair or service is required.

- Contact customer service personally.

or

- Go to the r-stahl.com website.
- Under "Support" > "RMA" > select "RMA-REQUEST".
- Fill out the form and send it.
You will automatically receive an RMA form via email. Please print this file off.
- Send the device along with the RMA form in the packaging to R. STAHL Schaltgeräte GmbH (refer to chapter 1.1 for the address).

10 Cleaning

- To avoid electrostatic charging, the devices located in potentially explosive areas may only be cleaned using a damp cloth.
- When cleaning with a damp cloth, use water or mild, non-abrasive, non-scratching cleaning agents.
- Do not use aggressive detergents or solvents.

11 Disposal

- Observe national and local regulations and statutory regulation regarding disposal.
- Separate materials when sending it for recycling.
- Ensure environmentally friendly disposal of all components according to the statutory regulations.

12 Accessories and Spare Parts

NOTICE

Malfunction or damage to the device due to the use of non-original components.

Non-compliance can result in material damage.

- Use only original accessories and spare parts from R. STAHL Schaltgeräte GmbH.



For accessories and spare parts, see data sheet on our homepage r-stahl.com.