

## Temperatur Input Modul für Zone 2 / Div. 2

Reihe 9482/33



## Inhaltsverzeichnis

1	Allgemeine Angaben .....	3
1.1	Hersteller .....	3
1.2	Angaben zur Betriebsanleitung .....	3
1.3	Weitere Dokumente .....	3
1.4	Konformität zu Normen und Bestimmungen .....	3
2	Erläuterung der Symbole .....	3
2.1	Symbole in der Betriebsanleitung .....	3
2.2	Warnhinweise .....	4
2.3	Symbole am Gerät .....	4
3	Sicherheitshinweise .....	5
3.1	Aufbewahrung der Betriebsanleitung .....	5
3.2	Qualifikation des Personals .....	5
3.3	Sichere Verwendung .....	5
3.4	Umbauten und Änderungen .....	6
4	Funktion und Geräteaufbau .....	7
4.1	Funktion .....	7
4.2	Geräteaufbau .....	8
5	Technische Daten .....	9
6	Projektierung .....	16
6.1	Anschlussbelegung steckbare Klemmen X1 und X2 .....	17
6.2	Leitungsfehlerunterdrückung .....	18
6.3	Anschlussbeispiel .....	19
6.4	Nachweis der Eigensicherheit .....	19
7	Transport und Lagerung .....	30
8	Montage und Installation .....	31
8.1	Maßangaben / Befestigungsmaße .....	31
8.2	Montage / Demontage, Gebrauchslage .....	31
8.3	Installation .....	34
9	Inbetriebnahme .....	35
9.1	Abgleich für 2-Leiter-Widerstandsthermometer .....	35
9.2	Potentiometer im Betrieb "4 Leiter schnell" (Joystick) .....	36
10	Betrieb .....	36
10.1	Anzeige .....	36
10.2	Fehlerbeseitigung .....	37
11	Instandhaltung, Wartung, Reparatur .....	38
11.1	Instandhaltung .....	38
11.2	Wartung .....	38
11.3	Reparatur .....	38
11.4	Rücksendung .....	39
12	Reinigung .....	39
13	Entsorgung .....	39
14	Zubehör und Ersatzteile .....	39

## 1 Allgemeine Angaben

### 1.1 Hersteller

R. STAHL Schaltgeräte GmbH  
Am Bahnhof 30  
74638 Waldenburg  
Germany

Tel.: +49 7942 943-0  
Fax: +49 7942 943-4333  
Internet: r-stahl.com  
E-Mail: info@r-stahl.com

### 1.2 Angaben zur Betriebsanleitung

ID-Nr.: 218150 / 948260310020  
Publikationsnummer: 2020-10-02-BA00-III-de-03

Die Originalbetriebsanleitung ist die englische Ausgabe.  
Diese ist rechtsverbindlich in allen juristischen Angelegenheiten.

### 1.3 Weitere Dokumente

- Kopplungsbeschreibung IS1+ (Download unter r-stahl.com)
- Anleitung "Erdung und Schirmung" (Download unter r-stahl.com)
- Datenblatt

Dokumente in weiteren Sprachen, siehe r-stahl.com.

### 1.4 Konformität zu Normen und Bestimmungen



Zertifikate und EU-Konformitätserklärung, siehe r-stahl.com.

Das Gerät verfügt über eine IECEx-Zulassung. Zertifikat siehe IECEx-Homepage:  
<http://iecex.iec.ch/>

Weitere nationale Zertifikate stehen unter dem folgenden Link zum Download bereit:  
<https://r-stahl.com/de/global/support/downloads/>.

## 2 Erläuterung der Symbole



### 2.1 Symbole in der Betriebsanleitung

Symbol	Bedeutung
	Tipps und Empfehlungen zum Gebrauch des Geräts
	Gefahr durch explosionsfähige Atmosphäre



## 2.2 Warnhinweise

Warnhinweise unbedingt befolgen, um das konstruktive und durch den Betrieb bedingte Risiko zu minimieren. Die Warnhinweise sind wie folgt aufgebaut:

- Signalwort: GEFAHR, WARNUNG, VORSICHT, HINWEIS
- Art und Quelle der Gefahr/des Schadens
- Folgen der Gefahr
- Ergreifen von Gegenmaßnahmen zum Vermeiden der Gefahr bzw. des Schadens

	<b>GEFAHR</b>
	Gefahren für Personen Nichtbeachtung der Anweisung führt zu schweren oder tödlichen Verletzungen bei Personen.
	<b>WARNUNG</b>
	Gefahren für Personen Nichtbeachtung der Anweisung kann zu schweren oder tödlichen Verletzungen bei Personen führen.
	<b>VORSICHT</b>
	Gefahren für Personen Nichtbeachtung der Anweisung kann zu leichten Verletzungen bei Personen führen.
<b>HINWEIS</b>	
Vermeidung von Sachschaden Nichtbeachtung der Anweisung kann zu einem Sachschaden am Gerät und/oder seiner Umgebung führen.	

## 2.3 Symbole am Gerät

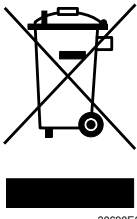
Symbol	Bedeutung
	CE-Kennzeichnung gemäß aktuell gültiger Richtlinie.
	Stromkreis gemäß Kennzeichnung für explosionsgefährdete Bereiche zertifiziert.
	Sicherheitshinweise, welche unerlässlich zur Kenntnis genommen werden müssen: Bei Geräten mit diesem Symbol sind die entsprechenden Daten und / oder die sicherheitsrelevanten Hinweise der Betriebsanleitung zu beachten!
	Kennzeichnung gemäß WEEE-Richtlinie 2012/19/EU

## 3 Sicherheitshinweise

### 3.1 Aufbewahrung der Betriebsanleitung

- Betriebsanleitung sorgfältig lesen.
- Betriebsanleitung am Einbauort des Geräts aufbewahren.
- Mitgeltende Dokumente und Betriebsanleitungen der anzuschließenden Geräte beachten.

### 3.2 Qualifikation des Personals

Für die in dieser Betriebsanleitung beschriebenen Tätigkeiten ist eine entsprechend qualifizierte Fachkraft erforderlich. Dies gilt vor allem für Arbeiten in den Bereichen

- Projektierung
- Montage/Demontage des Geräts
- (Elektrische) Installation
- Inbetriebnahme
- Instandhaltung, Reparatur, Reinigung

Fachkräfte, die diese Tätigkeiten ausführen, müssen einen Kenntnisstand haben, der relevante nationale Normen und Bestimmungen umfasst.

Für Tätigkeiten in explosionsgefährdeten Bereichen sind weitere Kenntnisse erforderlich!

R. STAHL empfiehlt einen Kenntnisstand, der in folgenden Normen beschrieben wird:

- IEC/EN 60079-14 (Projektierung, Auswahl und Errichtung elektrischer Anlagen)
- IEC/EN 60079-17 (Prüfung und Instandhaltung elektrischer Anlagen)
- IEC/EN 60079-19 (Gerätereparatur, Überholung und Regenerierung)

### 3.3 Sichere Verwendung

#### Vor der Montage

- Sicherheitshinweise in dieser Betriebsanleitung lesen und beachten!
- Sicherstellen, dass der Inhalt dieser Betriebsanleitung vom zuständigen Personal voll verstanden wurde.
- Gerät nur bestimmungsgemäß und nur für den zugelassenen Einsatzzweck verwenden.
- Bei Betriebsbedingungen, die durch die technischen Daten des Geräts nicht abgedeckt werden, unbedingt bei der R. STAHL Schaltgeräte GmbH rückfragen.
- Sicherstellen, dass das Gerät unbeschädigt ist.
- Für Schäden, die durch fehlerhaften oder unzulässigen Einsatz des Geräts sowie durch Nichtbeachtung dieser Betriebsanleitung entstehen, besteht keine Haftung.

#### Bei Montage und Installation



- Montage und Installation nur durch qualifizierte und autorisierte Personen (siehe Kapitel "Qualifikation des Personals") durchführen lassen.
- Gerät nur in Bereichen installieren, für die es aufgrund seiner Kennzeichnung geeignet ist.
- Bei Installation und im Betrieb die Angaben (Kennwerte und Bemessungsbetriebsbedingungen) auf Typ- und Datenschildern sowie die Hinweisschilder am Gerät beachten.
- Vor Installation sicherstellen, dass das Gerät unbeschädigt ist.

- Stromkreise der Zündschutzart "Ex i", die mit Stromkreisen anderer Zündschutzarten betrieben wurden, dürfen danach nicht mehr als Stromkreise der Zündschutzart "Ex i" betrieben werden.
- Bei Einsatz in Zone 2 oder Zone 22 ist das Gerät in ein schützendes Gehäuse oder einen Schrank entsprechend der IEC/EN 60079-0 einzubauen, die eine geeignete Schutzart bieten.
- Bei Einsatz in Zone 2 und im sicheren Bereich ist ein Gehäuse mit mindestens IP54 erforderlich.
- Bei Einsatz in Zone 22 ist ein Gehäuse mit mindestens IP64 nach IEC/EN 60079-31 erforderlich.
- Das Modul darf ausschließlich auf der BusRail 9494 montiert werden.
- Module mit eigensicheren und nicht-eigensicheren Feldstromkreisen dürfen gemischt auf einer BusRail betrieben werden. Hierbei sind 50 mm Abstand zwischen den Klemmen mit eigensicheren und nicht-eigensicheren Feldstromkreisen einzuhalten. (z.B.: Trennwand 220101 oder Leerplatz).
- Zusammenschaltung mehrerer aktiver, eigensicherer Feldstromkreise können zu anderen sicherheitstechnischen Maximalwerten führen. Dies kann die Eigensicherheit gefährden, so dass ein entsprechender Nachweis zu führen ist.
- Die sicherheitstechnischen Höchstwerte der angeschlossenen Feldgeräte müssen zu den Werten der Module gemäß Datenblatt, Betriebsanleitung oder EU-Baumusterprüfbescheinigung und Zertifikaten passen.

**Inbetriebnahme, Wartung, Reparatur**

- Inbetriebnahme und Instandsetzung nur durch qualifizierte und autorisierte Personen (siehe Kapitel "Qualifikation des Personals") durchführen lassen.
- Vor Inbetriebnahme sicherstellen, dass das Gerät unbeschädigt ist.
- Nur Wartungsarbeiten durchführen, die in dieser Betriebsanleitung beschrieben sind.
- Module und Steckverbinder dürfen im Betrieb in explosionsgefährdeten Bereichen gesteckt und getrennt werden (hot-swap und hot-plug).
- Gerät nur mit feuchtem Tuch reinigen, um elektrostatische Aufladung zu vermeiden.

**3.4 Umbauten und Änderungen**

	<p style="text-align: center;"><b>GEFAHR</b></p> <p>Explosionsgefahr durch Umbauten und Änderungen am Gerät! Nichtbeachten führt zu schweren oder tödlichen Verletzungen.</p> <ul style="list-style-type: none"> <li>• Gerät nicht umbauen oder verändern.</li> </ul>
	<p>Für Schäden, die durch Umbauten und Änderungen entstehen, besteht keine Haftung und keine Gewährleistung.</p>

## 4 Funktion und Geräteaufbau

	GEFAHR
	<p>Explosionsgefahr durch zweckentfremdete Verwendung! Nichtbeachten führt zu schweren oder tödlichen Verletzungen.</p> <ul style="list-style-type: none"> <li>• Gerät nur entsprechend den in dieser Betriebsanleitung festgelegten Betriebsbedingungen verwenden.</li> <li>• Gerät nur entsprechend dem in dieser Betriebsanleitung genannten Einsatzzweck verwenden.</li> </ul>

### 4.1 Funktion

#### Einsatzbereich

Das Temperatur Input Modul Typ 9482/33 dient zum Anschluss von bis zu 8 eigensicheren Temperatursensoren an das Remote I/O-System IS1+.

Das Temperatur Input Modul ist für den Einsatz in gasexplosionsgefährdeten Bereichen der Zone 2, in staubexplosionsgefährdeten Bereichen der Zone 22 sowie auch im sicheren Bereich zugelassen.

#### Arbeitsweise

Jeder Kanal kann als Eingang für Widerstandsthermometer und Widerstandsferngeber in 2-, 3- oder 4-Leitertechnik oder Thermoelementen und mV-Gebern verwendet werden. Bei der Verwendung von Widerstandsthermometern oder Widerstandsferngebern erfolgt der Leitungsabgleich bei 2-Leiter-Schaltung bei Bedarf über die Tastatur und das Display des zugehörigen CPU und Power Moduls (CPM bzw. CPU und PM) als auch automatisch über das Modul.

In der Betriebsart "4 Kanal schnell" (parametrierbar) werden sehr kurze Signalverzögerungen erreicht, wodurch spezielle Applikationen wie z.B. ein Joystick möglich sind.

Bei der Verwendung von Thermoelementen oder mV-Gebern kann die Kompensation der Vergleichsstellen-Temperatur intern an den Anschlussklemmen oder optional über die an Kanal 6 und 7 angeschlossene externe Vergleichsstelle (CJC) über ein Widerstandsthermometer erfolgen.

Jeder Eingang wird einzeln auf Drahtbruch und Kurzschluss überwacht.

Die Schnittstelle des Temperatur Input Moduls zum internen Datenbus der BusRail ist redundant ausgeführt.

	<p>Funktionskompatibler Ersatz für IS1 I/O-Module: Reihe 9480/12 und 9481/12.</p>
---	---

4.2 Geräteaufbau

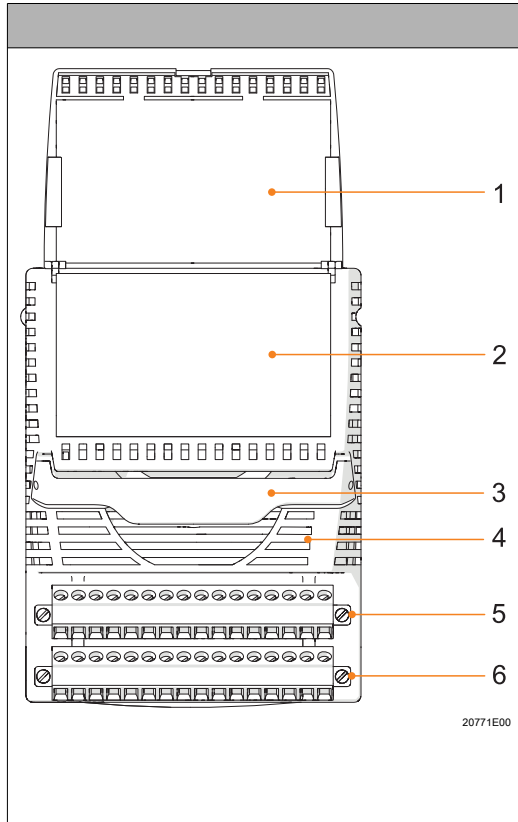

#	Gerätelement	Beschreibung
1	Abdeckklappe	Abdeckklappe mit Einlegeschild und Anschlussplan (geöffnet)
2	Beschriftung	Angaben zum Modul (Seriennummer, Hardware-Revisionsnummer, Software-Revisionsnummer, Herstellungsdatum, z.B.: 12345678914-004 Rev. A 01-01 0514)
3	Rasthebel	Rasthebel zum Entfernen des Moduls von der BusRail
4	LED	LED zur Anzeige Wartung ("M/S", blau), Betrieb ("RUN", grün) und Fehler ("ERR", rot) (weitere Informationen siehe Kapitel "Anzeigen")
5	Klemme	Steckbare Klemme X2 mit zwei Sicherungsschrauben
6	Klemme	Steckbare Klemme X1 mit zwei Sicherungsschrauben



## 5 Technische Daten

### Explosionsschutz

#### Global (IECEX)

Gas und Staub	IECEX DEK 13.0046X Ex ec ia [ia Ga] IIC T4 Gc [Ex ia Da] IIIC
---------------	---

#### Europa (ATEX)

Gas und Staub	DEKRA 13 ATEX 0140 X ⊕ II 3 (1) G Ex ec ia [ia Ga] IIC T4 Gc ⊕ II (1) D [Ex ia Da] IIIC
---------------	---

#### Bescheinigungen und Zertifikate

Bescheinigungen	IECEX, ATEX, Brasilien (INMETRO), Indien (PESO), Kanada (cFM), EAC (Eurasische Wirtschaftsunion), USA (FM)
Schiffszertifikate	EU RO Mutual Recognition (inkl. ABS, BV, CCS, CRS, DNV GL, IRS, KR, LR, ClassNK, PRS, RINA, RS)

#### Weitere Parameter

Installation	in Zone 2, Zone 22 und im sicheren Bereich
Weitere Angaben	siehe jeweilige Bescheinigung und Betriebsanleitung

#### Sicherheitstechnische Daten

Hinweis	siehe Kapitel "Nachweis der Eigensicherheit"
Max. innere Kapazität $C_i$	vernachlässigbar
Max. innere Induktivität $L_i$	vernachlässigbar

### Technische Daten

#### Elektrische Daten

Ex i Eingänge	
Widerstands-thermometer / Widerstandsgeber	
Anzahl Kanäle	8
Betriebsarten	8 Kanal genau / 4 Kanal schnell (Joystick)
Anschlussart	2-, 3-, 4- Leiterschaltung
Widerstandsbereich	0 ... 10 k $\Omega$
Messstrom	< 200 $\mu$ A gemultiplext
Max. Leitungswiderstand pro Ader	100 $\Omega$
Messgenauigkeit	0,025 % (8 Kanal genau) / $\pm$ 1 % (4 Kanal schnell Joystick)
Hinweis	Alle Angaben in % des Messbereiches bei 23 °C

**Technische Daten**

Einfluss der Umgebungstemperatur

0,025 % / 10 K

Linearität (parametrierbar)

temperaturlinear / widerstandslinear

Anschließbare Widerstandsthermometer / Widerstandsgeber

Typ	Referenz	Messbereich (ITS-90)	Mittlere Auflösung
Pt100	IEC 60751	-200 ... +850 °C	0,1 K
Pt500	IEC 60751	-200 ... +850 °C	0,1 K
Pt1000	IEC 60751	-200 ... +850 °C	0,1 K
Ni100	DIN 43760	-60 ... +180 °C	0,1 K
Ni500	DIN 43760	-60 ... +180 °C	0,1 K
Ni1000	DIN 43760	-60 ... +180 °C	0,1 K
Pt46	GOST 6651-94	-200 ... +1100 °C	0,15 K
Pt50	GOST 6651-94	-200 ... +1100 °C	0,15 K
Pt100	GOST 6651-94	-200 ... +1100 °C	0,1 K
Cu53	GOST 6651-94	-50 ... +180 °C	0,1 K
M50	GOST 6651-94	-200 ... +200 °C	0,15 K
M100	GOST 6651-94	-200 ... +200 °C	0,1 K
Widerstandsgeber (3-Leiter)	–	0 ... 500 Ω	0,02 Ω
Widerstandsgeber (3-Leiter)	–	0 ... 2,5 kΩ	0,10 Ω
Widerstandsgeber (3-Leiter)	–	0 ... 5 kΩ	0,20 Ω
Widerstandsgeber (3-Leiter)	–	0 ... 10 kΩ	0,4 Ω
Joystick (4-Leiter)	–	500 ... 10 kΩ	

## Technische Daten

Reaktionszeit	Typ	Schaltungsart	Betriebsart 4 Kanal schnell Fehlerüberwachung		Betriebsart 8 Kanal genau Fehlerüberwachung	
			aktiviert	deaktiviert	aktiviert	deaktiviert
			RTD	2-Leiter	400 ms	400 ms
RTD	3-Leiter	400 ms	400 ms	750 ms	720 ms	
RTD	4-Leiter	400 ms	400 ms	750 ms	720 ms	
R	2-Leiter in R	400 ms	400 ms	750 ms	720 ms	
R	3-Leiter in %	90 ms	70 ms	750 ms	720 ms	
R	4-Leiter in R	400 ms	400 ms	750 ms	720 ms	
R	4-Leiter in %	90 ms	70 ms	750 ms	720 ms	

Damit die Zeiten mit "Fehlerüberwachung deaktiviert" erreicht werden, muss bei allen Kanälen die Fehlerüberwachung "AUS" sein! Sobald nur bei einem Kanal die Fehlerüberwachung "EIN" ist, gelten die Zeiten für "Fehlerüberwachung aktiviert".

Thermoelemente / mV-Geber					
Anzahl Kanäle	8				
Betriebsarten	8 Kanal genau / 4 Kanal schnell				
Anschlussart	2-Leiterschaltung				
Signalbereich	-10 ... +100 mV				
Linearität (parametrierbar)	temperaturlinear / spannungslinear				
Hinweis	Alle Angaben in % des Messbereichs bei 23 °C				
Anschließbare Thermoelemente / mV-Geber	Typ	Referenz	Messbereich (ITS-90)	Mittlere Auflösung	Mittlere Messabweichung bezogen auf Messbereich
	B	IEC 60584-1	+400 ... +1800 °C	0,25 K	0,1 %
	E	IEC 60584-1	-200 ... +1000 °C	0,1 K	0,013 %
	J	IEC 60584-1	-200 ... +1200 °C	0,1 K	0,014 %
	K	IEC 60584-1	-200 ... +1370 °C	0,1 K	0,02 %
	N	IEC 60584-1	-200 ... +1300 °C	0,1 K	0,02 %
	R	IEC 60584-1	-50 ... +1767 °C	0,2 K	0,05 %
	S	IEC 60584-1	-50 ... +1767 °C	0,2 K	0,053 %
	T	IEC 60584-1	-200 ... +400 °C	0,1 K	0,042 %
	L	DIN 43710	-200 ... +900 °C	0,1 K	0,027 %
	U	DIN 43710	-200 ... +600 °C	0,1 K	0,038 %
	XK	GOST 8.585	-50 ... +800 °C	0,1 K	0,02 %
	mV	–	0 ... +100 mV	3,6 µV	0,01 %

**Technische Daten**

Reaktionszeit	Typ	Schaltungsart	Betriebsart 4 Kanal schnell Fehlerüberwachung		Betriebsart 8 Kanal genau Fehlerüberwachung	
			aktiviert	deaktiviert	aktiviert	deaktiviert
			Thermoelement	2-Leiter	500 ms	450 ms
0 ... 100 mV	2-Leiter	500 ms	450 ms	800 ms	750 ms	

Damit die Zeiten mit "Fehlerüberwachung deaktiviert" erreicht werden, muss bei allen Kanälen die Fehlerüberwachung "AUS" sein! Sobald nur bei einem Kanal die Fehlerüberwachung "EIN" ist, gelten die Zeiten für "Fehlerüberwachung aktiviert".

Eingangswiderstand	10 MΩ
Einfluss der Umgebungstemperatur	0,025 % / 10 K
Vergleichsstellen Kompensation	
Anzahl Kanäle	1 (Klemmstellen siehe Betriebsanleitung)
Betriebsarten	intern (parametrierbar) / extern 3-Leiterschaltung
Anschlussart	3- Leiterschaltung (extern)
Messbereich	-40 ... +80 °C
Messgenauigkeit	intern: 0,025% / extern: abhängig vom Sensortyp, siehe "Anschließbare Widerstandsthermometer"
Auflösung	0,1 K
Temperaturabweichung bei Thermoelementen mit interner Kompensation	± 2 K

## Technische Daten

Galvanische Trennung	
Prüfspannung	
gemäß Norm	EN 60079-11
Zwischen Hilfsenergie / Systemkomponenten	≥ 1500 V AC
Zwischen zwei I/O-Modulen	≥ 500 V AC
Zwischen I/O-Kanälen / Systemkomponenten	≥ 500 V AC
Zwischen I/O-Kanälen / Erde (PA)	≥ 500 V AC
Elektromagnetische Verträglichkeit	
Elektromagnetische Verträglichkeit	Geprüft nach folgenden Normen und Vorschriften: EN 61326-1, IEC 61000-4-1 ... 6, NAMUR NE 21
Messgenauigkeit	0,1 % (8 Kanal genau) siehe auch Hinweis Montage und Installation
Elektrischer Anschluss	
Energieversorgung	BusRail-Typen 9494
Ex i Feldsignale	Steckbare, blaue Klemmen, 16-polig, 2,5 mm <sup>2</sup> , Schraub- oder Federzugausführung mit Arretierung
Hilfsenergie	
Maximale Leistungsaufnahme	1 W
Maximale Verlustleistung	1 W

**Technische Daten****Gerätespezifische Daten**

Einstellungen	
Modul	
Diagnose-Meldung	EIN / AUS
Betriebsart	8 Kanal genau / 4 Kanal schnell
Auswahl Vergleichsstelle	intern / extern 3-Leiter
Typ externe Vergleichsstelle	PT100, PT1000, PT100 GOST
Signal	
Verhalten im Fehlerfall	letzten Wert halten
Fehlerüberwachung	EIN / AUS
Schaltungsart	2-, 3-, 4-Leiter

**Umgebungsbedingungen**

Umgebungstemperatur	-40 ... +75 °C
Lagertemperatur	-40 ... +80 °C
Maximale relative Luftfeuchte	95 % (ohne Betauung)
Maximale Einsatzhöhe	< 2000 m
Schock, halbsinusförmig (IEC/EN 60068-2-27)	15 g (3 Schocks pro Achse und Richtung)
Vibration, sinusförmig (IEC/EN 60068-2-6)	Frequenzbereich: 2 ... 13,2 Hz, Amplitude: 1,0 mm (Spitzenwert) Frequenzbereich: 13,2... 100 Hz, Beschleunigungsamplitude: 0,7 g

**Mechanische Daten**

Schutzart (IEC 60529)	IP20
Modulgehäuse	Polyamid 6GF
Brandfestigkeit (UL 94)	V2
Schadstoffklasse	entspricht G3
Abmessungen	L = 128 mm, B = 96,5 mm, H = 67 mm

**Technische Daten****Anzeige**

LED-Anzeige	
Wartungsbedarf Modul	LED "M/S", blau
Betriebszustand	LED "RUN", grün
Sammelfehler	LED "ERR", rot
Funktionsanzeige	
Abrufbare Parameter	Hersteller, Typ, HW-Revision, SW-Revision, Seriennummer
Fehleranzeige	
Modulstatus und -alarme	<ul style="list-style-type: none"> <li>• Fehler interner Bus primär / redundant</li> <li>• Keine Antwort vom IOM</li> <li>• Konfiguration ungleich Modul</li> <li>• Hardwarefehler</li> <li>• Übertemperatur</li> <li>• Fehler Steckplatz</li> <li>• Wartungsbedarf Modul</li> </ul>
Signalfehler je Kanal	
Signal- Status-Bit	"0" = Signal gestört; "1" = Signal gültig
Drahtbruch Eingang	Widerstandsthermometer / Widerstandsgeber: > 100 Ω; Thermoelemente / mV-Geber: > 1000 Ω
Kurzschluss Eingang	Widerstandsthermometer / Widerstandsgeber: < 15 Ω
Messbereich	Überschreitung / Unterschreitung

**Montage / Installation**

Einbaubedingungen	
Montageart	auf 35 mm DIN-Schiene NS 35/15 (DIN EN 60715)
Einbaulage	waagrecht oder senkrecht (Betriebsanleitung beachten)

Weitere technische Daten, siehe [r-stahl.com](http://r-stahl.com).

## 6 Projektierung

### HINWEIS

Ausfall der installierten Geräte im Schaltschrank durch zu hohe Umgebungstemperatur!

Nichtbeachten kann zu Sachschäden führen.

- Schaltschrank so aufbauen und einrichten, dass er immer innerhalb des zulässigen Temperaturbereichs betrieben wird.

Bei der Projektierung folgende Bedingungen beachten:

- Installation des Geräts zur bestimmungsgemäßen Verwendung nur auf der IS1 BusRail 9494.
- Drei zulässige Montagelagen für den Betrieb des Geräts: siehe Kapitel "Montage / Demontage auf BusRail".
- Module mit eigensicheren und nicht-eigensicheren Feldstromkreisen dürfen gemischt auf einer BusRail betrieben werden. Hierbei sind 50 mm Abstand zwischen den Klemmen mit eigensicheren zu denen mit nicht-eigensicheren Feldstromkreisen einzuhalten. (z.B.: Trennwand 220101 oder Leerplatz).



### 6.1 Anschlussbelegung steckbare Klemmen X1 und X2

Für das Modul sind zwei steckbare Klemmen X1 und X2 (Schraubklemmen 162702 und 162718 oder Federzugklemmen 162695 und 162716) zum Anschluss von Feldgeräten als Zubehör erhältlich (nicht im Lieferumfang des Moduls enthalten).

Die steckbaren Klemmen X1 und X2 haben je 16 Klemmstellen zum Anschluss der Feldkabel.

Anschlussbelegung steckbare Klemmen X1 und X2					
	Widerstandssensoren			Thermoelemente und mV-Geber	externe Vergleichsstelle
	2-Leiter	3-Leiter	4-Leiter	2 Leiter	3 Leiter
Kanal	X1- /X2-Klemmen			X1- /X2-Klemmen	X2-Klemmen
0	1 (I+), 4 (I-)	1 (I+), 3 (V-), 4 (I-)	1 (I+), 2 (V+), 3 (V-), 4 (I-)	2 (V+), 3 (V-)	–
1	5 (I+), 8 (I-)	5 (I+), 7 (V-), 8 (I-)	5 (I+), 6 (V+), 7 (V-), 8 (I-)	6 (V+), 7 (V-)	–
2	9 (I+), 12 (I-)	9 (I+), 11 (V-), 12 (I-)	9 (I+), 10 (V+), 11 (V-), 12 (I-)	10 (V+), 11 (V-)	–
3	13 (I+), 16 (I-)	13 (I+), 15 (V-), 16 (I-)	13 (I+), 14 (V+), 15 (V-), 16 (I-)	14 (V+), 15 (V-)	–
4	17 (I+), 20 (I-)	17 (I+), 19 (V-), 20 (I-)	17 (I+), 18 (V+), 19 (V-), 20 (I-)	18 (V+), 19 (V-)	–
5	21 (I+), 24 (I-)	21 (I+), 23 (V-), 24 (I-)	21 (I+), 22 (V+), 23 (V-), 24 (I-)	22 (V+), 23 (V-)	–
6	25 (I+), 28 (I-)	25 (I+), 27 (V-), 28 (I-)	25 (I+), 26 (V+), 27 (V-), 28 (I-)	26 (V+), 27 (V-)	25 (I+)
7	29 (I+), 32 (I-)	29 (I+), 31 (V-), 32 (I-)	29 (I+), 30 (V+), 31 (V-), 32 (I-)	30 (V+), 31 (V-)	29 (I+), 32 (I-)

Die Signaleingänge sind untereinander galvanisch verbunden. Da sie als Differenzeingänge ausgelegt sind, werden Erdschleifen bei geerdeten Thermoelementen wirksam unterbunden.

## 6.2 Leitungsfehlerunterdrückung

Nicht verwendete Kanäle können zur Unterdrückung von Leitungsfehler-Meldungen optional mit Widerständen (einfaches elektrisches Betriebsmittel für eigensichere Stromkreise gemäß EN 60079-11) beschaltet werden.

<b>i</b>	Die Widerstände sind als Zubehör erhältlich.
----------	--

Je nach Signal-Typ kann wie folgt bestückt werden, z.B. Kanal 0:

2-Leiter TC/Vm-Geber	62R zwischen Klemmstelle 2 und 3
2-Leiter RTD	62R zwischen Klemmstelle 1 und 4
3-Leiter RTD	62R zwischen Klemmstelle 2 und 3, wobei 3 und 4 gebrückt werden
4-Leiter RTD	62R zwischen Klemmstelle 2 und 3, wobei 1 und 2 sowie 3 und 4 gebrückt werden

### 6.3 Anschlussbeispiel

Anschluss von bis zu 8 Thermoelementen oder mV-Gebern zusammen mit Widerstandsthermometern und externer Vergleichsstelle.

Mögliche Mischung unterschiedlicher Signale, z.B.:

- Thermoelemente oder mV-Geber am Kanal 0, 2, 6 und 7
- Widerstandsthermometer oder Widerstandsferngeber am Kanal 1, 3 und 5
- externe Vergleichsstelle am Kanal 6 und 7

**RTD und Potentiometer mit Thermoelementen und mV-Gebern mit externer CJC**

Kanal	Thermoelement / mV-Geber	RTD 2-Leiter	RTD 3-Leiter	externe CJC 3-Leiter / RTD 4-Leiter
0	2 (V+), 3 (V-)	–	–	–
1	6 (V+), 7 (V-)	–	–	–
2	–	–	9 (I+), 11 (V-), 12 (I-)	–
3	–	13 (I+), 16 (I-)	–	–
4	–	–	–	17 (I+), 18 (V+), 19 (V-), 20 (I-)
5	–	–	–	21 (I+), 22 (V+), 23 (V-), 24 (I-)
6	26 (V+), 27 (V-)	–	–	25 (I+), 29 (I+), 32 (I-)
7	30 (V+), 31 (V-)	–	–	

**i** Die sicherheitstechnischen Daten des Anschlussbeispiels werden nach der Beschaltungsart I ermittelt!

### 6.4 Nachweis der Eigensicherheit

Für den Nachweis der Eigensicherheit werden je nach verwendetem Sensor, Sensorkombination und Beschaltung die sicherheitstechnischen Daten angegeben. Für alle verwendeten Sensoren müssen entsprechend den im Folgenden aufgeführten Sensor Beschaltungen die jeweiligen sicherheitstechnische Daten entnommen werden: Das Modul unterstützt die unterschiedlichen Temperatursensoren (Widerstandsthermometer, Widerstandsgeber, Thermoelemente und mV-Geber) sowohl in reiner als auch in gemischter Beschaltung. Je nach Beschaltung ergeben sich unterschiedliche sicherheitstechnische Daten für den jeweiligen Messkanal. Das Flussdiagramm dient zur richtigen Auswahl der sicherheitstechnischen Daten.

6.4.1 Flussdiagramm zur Auswahl der sicherheitstechnischen Daten

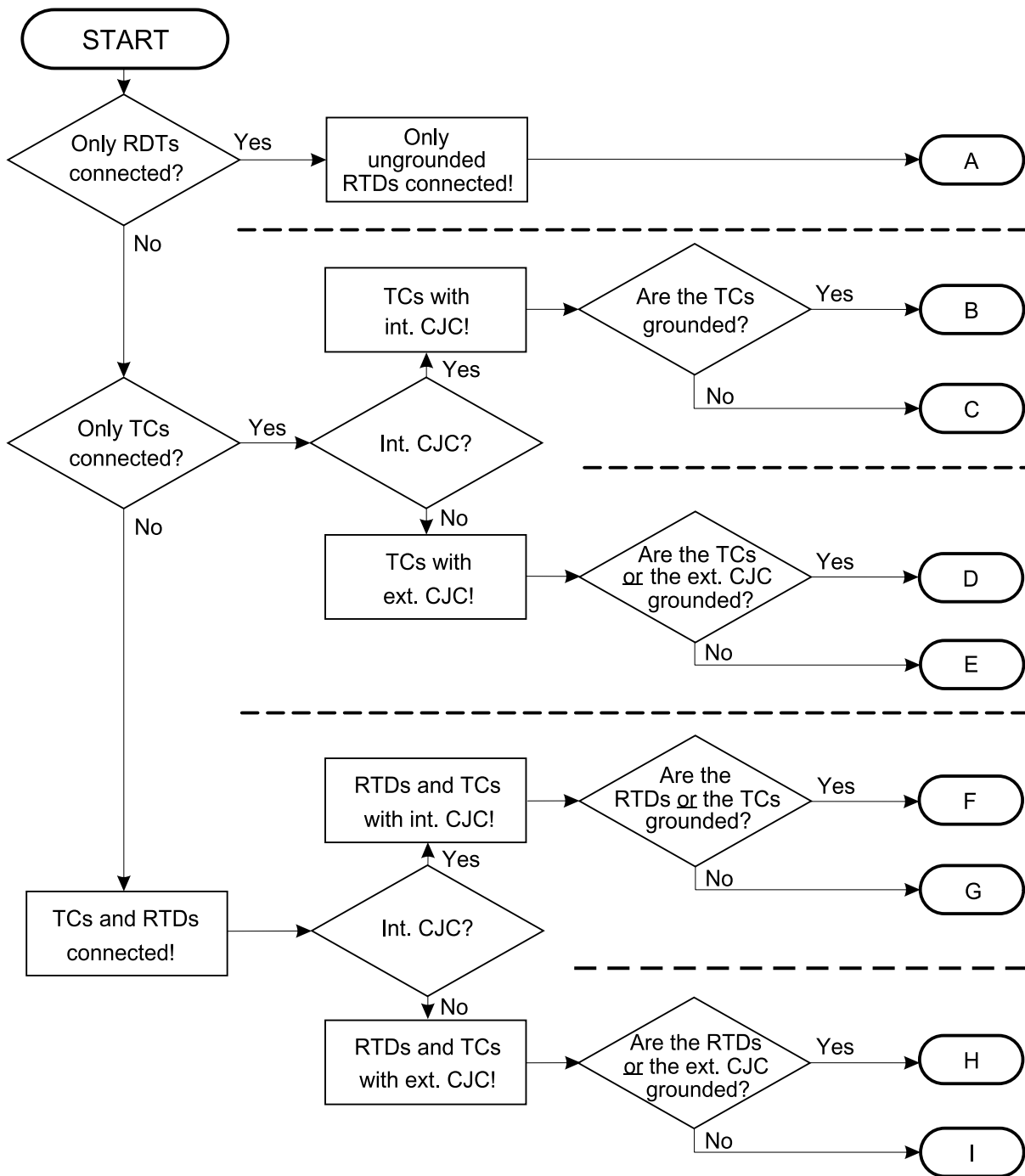

16556E00

**Legende**

- RTD = Widerstandsthermometer und / oder Widerstandsferngeber
- TC = Thermoelemente und / oder mV-Geber
- Ext. / Int. CJC = externe / interne Vergleichsstelle
- ungrounded / grounded = isoliert / geerdet

## 6.4.2 Mögliche Beschaltungsarten

<p><b>i</b></p>	<p>Die folgenden sicherheitstechnischen Daten gelten nur für die</p> <ul style="list-style-type: none"> <li>• Beschaltung mit Widerstandsthermometern und Widerstandsgebern (Beschaltungsart A)</li> <li>• Beschaltung mit Thermoelementen und mV-Gebern (Beschaltungsart B – E)</li> <li>• Beschaltungs-Kombinationen mit Widerstandsthermometern und Widerstandsgebern sowie Thermoelementen und mV-Gebern (Beschaltungsarten F – I)</li> </ul> <p>Bitte beachten:</p> <ul style="list-style-type: none"> <li>• Die Beschaltungsarten unterscheiden sich durch die angegebenen elektrischen Schutzmaßnahmen (erden, isolieren) und die angeschlossenen Vergleichsstellen (intern, extern) der Temperatursensoren!</li> <li>• Die sicherheitstechnischen Daten müssen für Thermoelemente, Widerstandssensoren und externe Vergleichsstellen jeweils getrennt ermittelt werden.</li> <li>• Die Temperatursensoren dürfen in der Regel in beliebiger Konstellation angeschlossen werden. Bei Anschluss weiterer Thermo- oder Widerstandssensoren bitte die Kombinations-Beschaltungsarten F – I heranziehen.</li> <li>• Eine externe Vergleichsstelle darf ausschließlich an die Kanäle 6 und 7 angeschlossen werden.</li> </ul>
<p><b>i</b></p>	<p>Weitere Sicherheitstechnische Höchstwerte dem Zertifikat entnehmen!</p>

**Beschaltungsart A: only RTD, ungrounded**

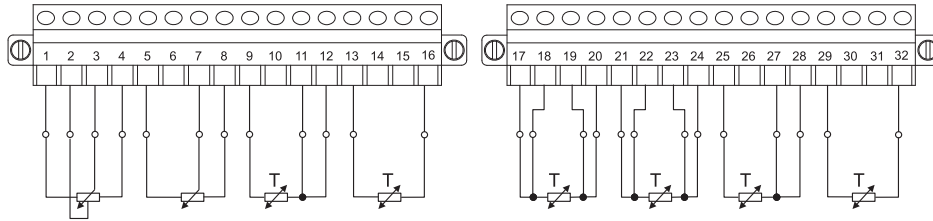

17810E00

**Bis zu 8 Widerstandsthermometer oder Widerstandsgeber**

Hinweis	keine Thermoelemente / mV-Geber angeschlossen, keine Vergleichsstelle angeschlossen						
Installationsart	isoliert						
Max. Ausgangsspannung	6,42 V						
$U_{o\ ext}$							
Max. Strom $I_o$	2 Leiter		3 Leiter		4 Leiter		
Max. Leistung $P_o$	6,5 mA		7,8 mA		9,8 mA		
Max. anschließbare Kapazität $C_o$	10,5 mW		12,5 mW		15,7 mW		
IIC	1,1 $\mu$ F	1,2 $\mu$ F	1,4 $\mu$ F	2,0 $\mu$ F	3,2 $\mu$ F	7,0 $\mu$ F	25 $\mu$ F
IIB / IIIC	5,8 $\mu$ F	6,3 $\mu$ F	7,1 $\mu$ F	10 $\mu$ F	19 $\mu$ F	51 $\mu$ F	570 $\mu$ F
Max. anschließbare Induktivität $L_o$							
IIC	100 mH	50 mH	20 mH	2 mH	0,2 mH	0,02 mH	0,002 mH
IIB / IIIC	100 mH	50 mH	20 mH	2 mH	0,2 mH	0,02 mH	0,002 mH

### Beschaltungsart B: TC with int. CJC, grounded

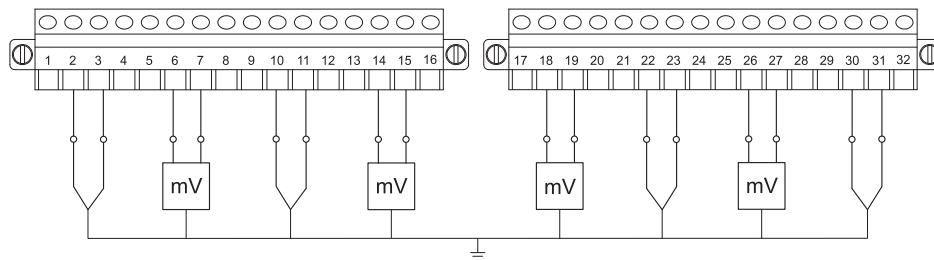

16553E00

Bis zu 8 geerdete Thermoelemente oder mV-Geber mit interner Vergleichsstelle

Installationsart	geerdet						
Vergleichsstelle	intern						
Max. Ausgangsspannung	12,92 V						
$U_{o\ ext}$							
Max. Strom $I_o$	25,0 mA						
Max. Leistung $P_o$	81,0 mW						
Max. Eingangsspannung $U_i$	6,5 V (für $U_i = 3,5$ V siehe Tabelle im Zertifikat)						
Max. anschließbare Kapazität $C_o$							
IIC	0,17 $\mu$ F	0,22 $\mu$ F	0,34 $\mu$ F	0,46 $\mu$ F	0,53 $\mu$ F	0,62 $\mu$ F	0,78 $\mu$ F
IIB / IIIC	1,2 $\mu$ F	1,6 $\mu$ F	2,1 $\mu$ F	3,0 $\mu$ F	3,5 $\mu$ F	4,5 $\mu$ F	5,7 $\mu$ F
Max. anschließbare Induktivität $L_o$							
IIC	72 mH	50 mH	10 mH	2 mH	1 mH	0,5 mH	0,2 mH
IIB / IIIC	100 mH	20 mH	5 mH	1 mH	0,5 mH	0,2 mH	0,1 mH

### Beschaltungsart C: TC with int. CJC, ungrounded

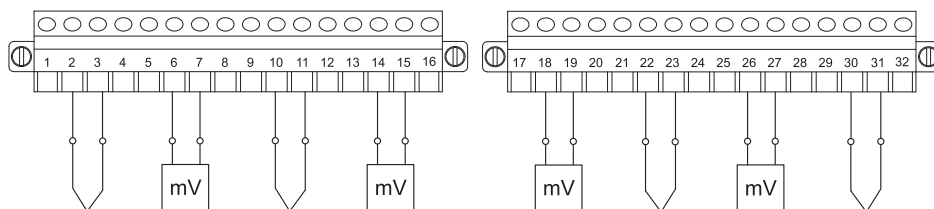

17811E00

Bis zu 8 isolierte Thermoelemente oder mV-Geber mit intern Vergleichsstelle

Installationsart	isoliert						
Vergleichsstelle	intern						
Max. Ausgangsspannung	12,92 V						
$U_{o\ ext}$							
Max. Strom $I_o$	6,53 mA						
Max. Leistung $P_o$	21,1 mW						
Max. Eingangsspannung $U_i$	6,5 V (für $U_i = 3,5$ V siehe Tabelle im Zertifikat)						
Max. anschließbare Kapazität $C_o$							
IIC	0,30 $\mu$ F	0,32 $\mu$ F	0,38 $\mu$ F	0,42 $\mu$ F	0,55 $\mu$ F	0,63 $\mu$ F	0,79 $\mu$ F
IIB / IIIC	1,5 $\mu$ F	1,6 $\mu$ F	1,9 $\mu$ F	3,0 $\mu$ F	3,5 $\mu$ F	4,6 $\mu$ F	5,7 $\mu$ F
Max. anschließbare Induktivität $L_o$							
IIC	100 mH	50 mH	10 mH	5 mH	1 mH	0,5 mH	0,2 mH
IIB / IIIC	100 mH	50 mH	10 mH	1 mH	0,5 mH	0,2 mH	0,1 mH

**Beschaltungsart D: TC with ext. CJC, grounded**

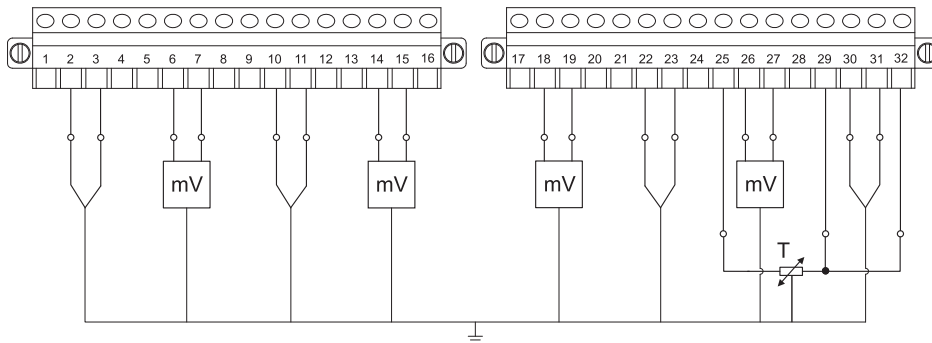

16558E00

Bis zu 8 geerdete Thermoelemente oder mV-Geber mit externer Vergleichsstelle

Installationsart	geerdet							
Vergleichsstelle	extern							
Max. Ausgangsspannung	12,92 V							
$U_{o\ ext}$								
Max. Strom $I_o$	25,0 mA							
Max. Leistung $P_o$	81,0 mW							
Max. Eingangsspannung	6,5 V (für $U_i = 3,5$ V siehe Tabelle im Zertifikat)							
$U_i$								
Max. anschließbare Kapazität $C_o$								
IIC	0,17 $\mu$ F	0,22 $\mu$ F	0,34 $\mu$ F	0,46 $\mu$ F	0,53 $\mu$ F	0,62 $\mu$ F	0,78 $\mu$ F	
IIB / IIIC	1,2 $\mu$ F	1,6 $\mu$ F	2,1 $\mu$ F	3,0 $\mu$ F	3,5 $\mu$ F	4,5 $\mu$ F	5,7 $\mu$ F	
Max. anschließbare Induktivität $L_o$								
IIC	72 mH	50 mH	10 mH	2 mH	1 mH	0,5 mH	0,2 mH	
IIB / IIIC	100 mH	20 mH	5 mH	1 mH	0,5 mH	0,2 mH	0,1 mH	

**Geerdete externe Vergleichsstelle**

Installationsart	geerdet							
Vergleichsstelle	extern (3-Leiter)							
Max. Ausgangsspannung	12,92 V							
$U_{o\ ext}$								
Max. Strom $I_o$	68,6 mA							
Max. Leistung $P_o$	222,0 mW							
Max. Eingangsspannung	6,5 V (für $U_i = 3,5$ V siehe Tabelle im Zertifikat)							
$U_i$								
Max. anschließbare Kapazität $C_o$								
IIC	0,25 $\mu$ F	0,27 $\mu$ F	0,39 $\mu$ F	0,48 $\mu$ F	0,58 $\mu$ F	0,75 $\mu$ F	0,92 $\mu$ F	
IIB / IIIC	1 $\mu$ F	1,1 $\mu$ F	1,5 $\mu$ F	1,9 $\mu$ F	2,8 $\mu$ F	3,4 $\mu$ F	5,6 $\mu$ F	
Max. anschließbare Induktivität $L_o$								
IIC	5,6 mH	5 mH	2 mH	1 mH	0,5 mH	0,2 mH	0,1 mH	
IIB / IIIC	25 mH	20 mH	10 mH	5 mH	1 mH	0,5 mH	0,1 mH	



**Beschaltungsart E: TC with ext. CJC, ungrounded**

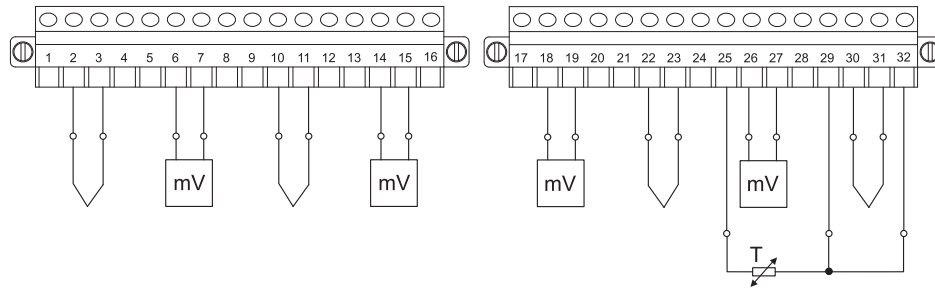

16498E00

**Bis zu 8 isolierte Thermoelemente oder mV-Geber mit externer Vergleichsstelle**

Installationsart	isoliert						
Vergleichsstelle	extern						
Max. Ausgangsspannung	12,92 V						
$U_{o\ ext}$							
Max. Strom $I_o$	6,53 mA						
Max. Leistung $P_o$	21,1 mW						
Max. Eingangsspannung $U_i$	6,5 V (für $U_i = 3,5$ V siehe Tabelle im Zertifikat)						
Max. anschließbare Kapazität $C_o$							
IIC	0,30 $\mu$ F	0,32 $\mu$ F	0,38 $\mu$ F	0,42 $\mu$ F	0,55 $\mu$ F	0,63 $\mu$ F	0,79 $\mu$ F
IIB / IIIC	1,5 $\mu$ F	1,6 $\mu$ F	1,9 $\mu$ F	3,0 $\mu$ F	3,5 $\mu$ F	4,6 $\mu$ F	5,7 $\mu$ F
Max. anschließbare Induktivität $L_o$							
IIC	100 mH	50 mH	10 mH	5 mH	1 mH	0,5 mH	0,2 mH
IIB / IIIC	100 mH	50 mH	10 mH	1 mH	0,5 mH	0,2 mH	0,1 mH

**Isolierte externe Vergleichsstelle**

Installationsart	isoliert						
Vergleichsstelle	extern (3-Leiter)						
Max. Ausgangsspannung	12,92 V						
$U_{o\ ext}$							
Max. Strom $I_o$	17,4 mA						
Max. Leistung $P_o$	56,2 mW						
Max. Eingangsspannung $U_i$	6,5 V (für $U_i = 3,5$ V siehe Tabelle im Zertifikat)						
Max. anschließbare Kapazität $C_o$							
IIC	0,17 $\mu$ F	0,21 $\mu$ F	0,29 $\mu$ F	0,39 $\mu$ F	0,53 $\mu$ F	0,62 $\mu$ F	0,78 $\mu$ F
IIB / IIIC	1,2 $\mu$ F	1,6 $\mu$ F	2,1 $\mu$ F	2,9 $\mu$ F	3,5 $\mu$ F	4,5 $\mu$ F	5,7 $\mu$ F
Max. anschließbare Induktivität $L_o$							
IIC	66 mH	50 mH	20 mH	5 mH	1 mH	0,5 mH	0,2 mH
IIB / IIIC	100 mH	20 mH	5 mH	1 mH	0,5 mH	0,2 mH	0,1 mH

**Beschaltungsart F: RTD and TC Mixed with int. CJC, grounded**

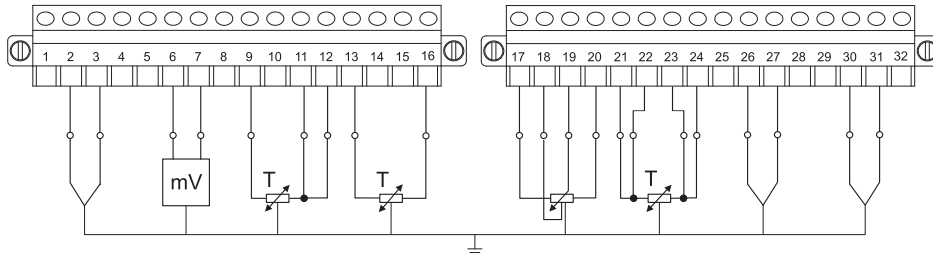

16560E00

**Bis zu 8 geerdete Thermoelemente oder mV-Geber mit interner Vergleichsstelle**

Installationsart	geerdet							
Vergleichsstelle	intern							
Max. Ausgangsspannung	12,92 V							
$U_{o\ ext}$								
Max. Strom $I_o$	25,0 mA							
Max. Leistung $P_o$	81,0 mW							
Max. Eingangsspannung $U_i$	6,5 V (für $U_i = 3,5$ V siehe Tabelle im Zertifikat)							
Max. anschließbare Kapazität $C_o$								
IIC	0,17 $\mu$ F	0,22 $\mu$ F	0,34 $\mu$ F	0,46 $\mu$ F	0,53 $\mu$ F	0,62 $\mu$ F	0,78 $\mu$ F	
IIB / IIIC	1,2 $\mu$ F	1,6 $\mu$ F	2,1 $\mu$ F	3,0 $\mu$ F	3,5 $\mu$ F	4,5 $\mu$ F	5,7 $\mu$ F	
Max. anschließbare Induktivität $L_o$								
IIC	72 mH	50 mH	10 mH	2 mH	1 mH	0,5 mH	0,2 mH	
IIB / IIIC	100 mH	20 mH	5 mH	1 mH	0,5 mH	0,2 mH	0,1 mH	

**Bis zu 8 geerdete Widerstandsthermometer oder Widerstandsgeber**

Installationsart	geerdet							
Max. Ausgangsspannung	12,92 V							
$U_{o\ ext}$								
Max. Strom $I_o$	2 Leiter 47,9 mA		3 Leiter 58,5 mA		4 Leiter 68,8 mA			
Max. Leistung $P_o$	155,0 mW		189,0 mW		220,0 mW			
Max. Eingangsspannung $U_i$	6,5 V (für $U_i = 3,5$ V siehe Tabelle im Zertifikat)							
Max. anschließbare Kapazität $C_o$								
IIC	0,23 $\mu$ F	0,31 $\mu$ F	0,41 $\mu$ F	0,50 $\mu$ F	0,60 $\mu$ F	0,76 $\mu$ F	0,93 $\mu$ F	
IIB / IIIC	0,94 $\mu$ F	1,3 $\mu$ F	1,6 $\mu$ F	1,9 $\mu$ F	2,9 $\mu$ F	3,4 $\mu$ F	5,6 $\mu$ F	
Max. anschließbare Induktivität $L_o$								
IIC	9 mH	5 mH	2 mH	1 mH	0,5 mH	0,2 mH	0,1 mH	
IIB / IIIC	40 mH	20 mH	10 mH	5 mH	1 mH	0,5 mH	0,1 mH	

**Beschaltungsart G: RTD and TC Mixed with int. CJC, ungrounded**

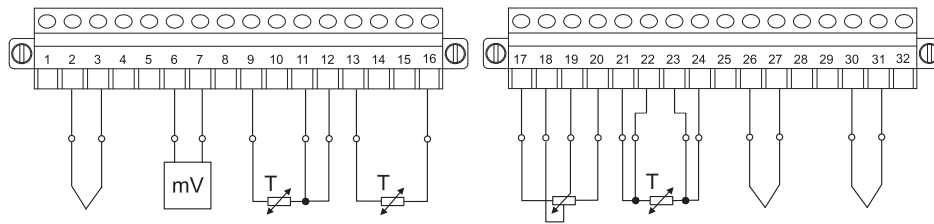

16559E00

**Bis zu 8 isolierte Thermoelemente oder mV-Geber mit interner Vergleichsstelle**

Installationsart	isoliert						
Vergleichsstelle	intern						
Max. Ausgangsspannung	12,92 V						
$U_{o\ ext}$							
Max. Strom $I_o$	6,53 mA						
Max. Leistung $P_o$	21,1 mW						
Max. Eingangsspannung	6,5 V (für $U_i = 3,5$ V siehe Tabelle im Zertifikat)						
$U_i$							
Max. anschließbare Kapazität $C_o$							
IIC	0,30 $\mu$ F	0,32 $\mu$ F	0,38 $\mu$ F	0,42 $\mu$ F	0,55 $\mu$ F	0,63 $\mu$ F	0,79 $\mu$ F
IIB / IIIC	1,5 $\mu$ F	1,6 $\mu$ F	1,9 $\mu$ F	3,0 $\mu$ F	3,5 $\mu$ F	4,6 $\mu$ F	5,7 $\mu$ F
Max. anschließbare Induktivität $L_o$							
IIC	100 mH	50 mH	10 mH	5 mH	1 mH	0,5 mH	0,2 mH
IIB / IIIC	100 mH	50 mH	10 mH	1 mH	0,5 mH	0,2 mH	0,1 mH

**Bis zu 8 isolierte Widerstandsthermometer oder Widerstandsgeber**

Installationsart	isoliert						
Max. Ausgangsspannung	12,92 V						
$U_{o\ ext}$							
Max. Strom $I_o$	2 Leiter 13,1 mA		3 Leiter 15,7 mA		4 Leiter 19,6 mA		
Max. Leistung $P_o$	42,2 mW		50,6 mW		63,3 mW		
Max. Eingangsspannung	6,5 V (für $U_i = 3,5$ V siehe Tabelle im Zertifikat)						
$U_i$							
Max. anschließbare Kapazität $C_o$							
IIC	0,19 $\mu$ F	0,25 $\mu$ F	0,31 $\mu$ F	0,40 $\mu$ F	0,54 $\mu$ F	0,63 $\mu$ F	0,78 $\mu$ F
IIB / IIIC	1,3 $\mu$ F	1,7 $\mu$ F	1,9 $\mu$ F	2,5 $\mu$ F	3,0 $\mu$ F	3,5 $\mu$ F	5,7 $\mu$ F
Max. anschließbare Induktivität $L_o$							
IIC	100 mH	50 mH	20 mH	5 mH	1 mH	0,5 mH	0,2 mH
IIB / IIIC	100 mH	20 mH	10 mH	2 mH	1 mH	0,5 mH	0,1 mH

**Beschaltungsart H: RTD and TC Mixed with ext. CJC, grounded**

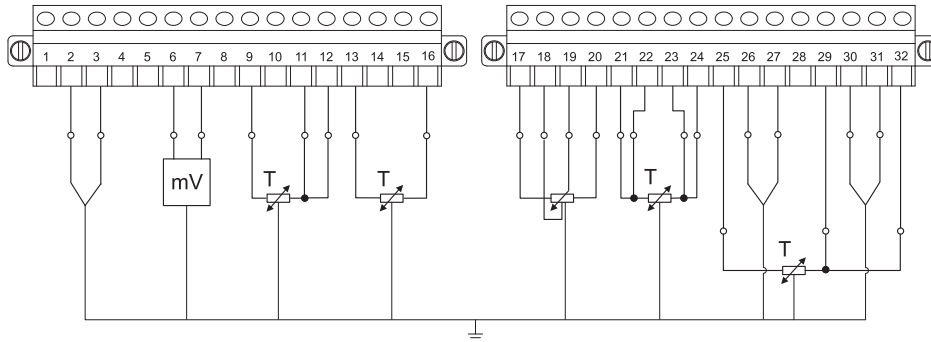

16561E00

**Bis zu 8 geerdete Thermoelemente oder mV-Geber mit externer Vergleichsstelle**

Installationsart	geerdet						
Vergleichsstelle	extern						
Max. Ausgangsspannung	12,92 V						
$U_{o\ ext}$							
Max. Strom $I_o$	25,0 mA						
Max. Leistung $P_o$	81,0 mW						
Max. Eingangsspannung	6,5 V (für $U_i = 3,5$ V siehe Tabelle im Zertifikat)						
$U_i$							
Max. anschließbare Kapazität $C_o$							
IIC	0,17 $\mu$ F	0,22 $\mu$ F	0,34 $\mu$ F	0,46 $\mu$ F	0,53 $\mu$ F	0,62 $\mu$ F	0,78 $\mu$ F
IIB / IIIC	1,2 $\mu$ F	1,6 $\mu$ F	2,1 $\mu$ F	3,0 $\mu$ F	3,5 $\mu$ F	4,5 $\mu$ F	5,7 $\mu$ F
Max. anschließbare Induktivität $L_o$							
IIC	72 mH	50 mH	10 mH	2 mH	1 mH	0,5 mH	0,2 mH
IIB / IIIC	100 mH	20 mH	5 mH	1 mH	0,5 mH	0,2 mH	0,1 mH

**Bis zu 8 geerdete Widerstandsthermometer oder Widerstandsgeber**

Installationsart	geerdet						
Max. Ausgangsspannung	12,92 V						
$U_{o\ ext}$							
Max. Strom $I_o$	2 Leiter	3 Leiter	4 Leiter				
Max. Leistung $P_o$	47,9 mA	58,5 mA	68,8 mA				
Max. Leistung $P_o$	155,0 mW	189,0 mW	220,0 mW				
Max. Eingangsspannung	6,5 V (für $U_i = 3,5$ V siehe Tabelle im Zertifikat)						
$U_i$							
Max. anschließbare Kapazität $C_o$							
IIC	0,23 $\mu$ F	0,31 $\mu$ F	0,41 $\mu$ F	0,50 $\mu$ F	0,60 $\mu$ F	0,76 $\mu$ F	0,93 $\mu$ F
IIB / IIIC	0,94 $\mu$ F	1,3 $\mu$ F	1,6 $\mu$ F	1,9 $\mu$ F	2,9 $\mu$ F	3,4 $\mu$ F	5,6 $\mu$ F
Max. anschließbare Induktivität $L_o$							
IIC	9 mH	5 mH	2 mH	1 mH	0,5 mH	0,2 mH	0,1 mH
IIB / IIIC	40 mH	20 mH	10 mH	5 mH	1 mH	0,5 mH	0,1 mH

### Geerdete externe Vergleichsstelle

Installationsart	geerdet						
Vergleichsstelle	extern (3 Leiter)						
Max. Ausgangsspannung	12,92 V						
$U_{o\ ext}$							
Max. Strom $I_o$	68,8 mA						
Max. Leistung $P_o$	222,0 mW						
Max. Eingangsspannung $U_i$	6,5 V (für $U_i = 3,5$ V siehe Tabelle im Zertifikat)						
Max. anschließbare Kapazität $C_o$							
IIC	0,25 $\mu$ F	0,27 $\mu$ F	0,39 $\mu$ F	0,48 $\mu$ F	0,58 $\mu$ F	0,75 $\mu$ F	0,92 $\mu$ F
IIB / IIIC	1 $\mu$ F	1,1 $\mu$ F	1,5 $\mu$ F	1,9 $\mu$ F	2,8 $\mu$ F	3,4 $\mu$ F	5,6 $\mu$ F
Max. anschließbare Induktivität $L_o$							
IIC	5,6 mH	5 mH	2 mH	1 mH	0,5 mH	0,2 mH	0,1 mH
IIB / IIIC	25 mH	20 mH	10 mH	5 mH	1 mH	0,5 mH	0,1 mH

### Beschaltungsart I: RTD and TC Mixed with ext. CJC, ungrounded

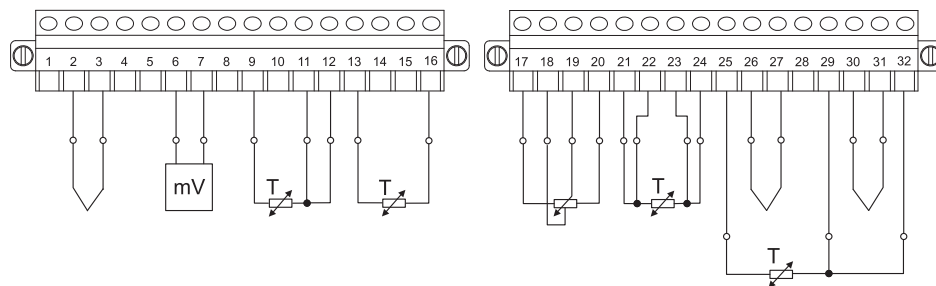

16497E00

### Bis zu 8 isolierte Thermoelemente oder mV-Geber mit externer Vergleichsstelle

Installationsart	isoliert						
Vergleichsstelle	extern						
Max. Ausgangsspannung	12,92 V						
$U_{o\ ext}$							
Max. Strom $I_o$	6,53 mA						
Max. Leistung $P_o$	21,1 mW						
Max. Eingangsspannung $U_i$	6,5 V (für $U_i = 3,5$ V siehe Tabelle im Zertifikat)						
Max. anschließbare Kapazität $C_o$							
IIC	0,30 $\mu$ F	0,32 $\mu$ F	0,38 $\mu$ F	0,42 $\mu$ F	0,55 $\mu$ F	0,63 $\mu$ F	0,79 $\mu$ F
IIB / IIIC	1,5 $\mu$ F	1,6 $\mu$ F	1,9 $\mu$ F	3,0 $\mu$ F	3,5 $\mu$ F	4,6 $\mu$ F	5,7 $\mu$ F
Max. anschließbare Induktivität $L_o$							
IIC	100 mH	50 mH	10 mH	5 mH	1 mH	0,5 mH	0,2 mH
IIB / IIIC	100 mH	50 mH	10 mH	1 mH	0,5 mH	0,2 mH	0,1 mH

Bis zu 8 isolierte Widerstandsthermometer oder Widerstandsgeber

Installationsart	isoliert							
Max. Ausgangsspannung $U_{o\ ext}$	12,92 V							
	2 Leiter		3 Leiter		4 Leiter			
Max. Strom $I_o$	13,1 mA		15,7 mA		19,6 mA			
Max. Leistung $P_o$	42,2 mW		50,6 mW		63,3 mW			
Max. Eingangsspannung $U_i$	6,5 V (für $U_i = 3,5$ V siehe Tabelle im Zertifikat)							
Max. anschließbare Kapazität $C_o$								
IIC	0,19 $\mu$ F	0,25 $\mu$ F	0,31 $\mu$ F	0,40 $\mu$ F	0,54 $\mu$ F	0,63 $\mu$ F	0,78 $\mu$ F	
IIB / IIIC	1,3 $\mu$ F	1,7 $\mu$ F	1,9 $\mu$ F	2,5 $\mu$ F	3,0 $\mu$ F	3,5 $\mu$ F	5,7 $\mu$ F	
Max. anschließbare Induktivität $L_o$								
IIC	100 mH	50 mH	20 mH	5 mH	1 mH	0,5 mH	0,2 mH	
IIB / IIIC	100 mH	20 mH	10 mH	2 mH	1 mH	0,5 mH	0,1 mH	

Isolierte externe Vergleichsstelle

Installationsart	isoliert							
Vergleichsstelle	extern (3 Leiter)							
Max. Ausgangsspannung $U_{o\ ext}$	12,92 V							
Max. Strom $I_o$	17,4 mA							
Max. Leistung $P_o$	56,2 mW							
Max. Eingangsspannung $U_i$	6,5 V (für $U_i = 3,5$ V siehe Tabelle im Zertifikat)							
Max. anschließbare Kapazität $C_o$								
IIC	0,17 $\mu$ F	0,21 $\mu$ F	0,29 $\mu$ F	0,39 $\mu$ F	0,53 $\mu$ F	0,62 $\mu$ F	0,78 $\mu$ F	
IIB / IIIC	1,2 $\mu$ F	1,6 $\mu$ F	2,1 $\mu$ F	2,9 $\mu$ F	3,5 $\mu$ F	4,5 $\mu$ F	5,7 $\mu$ F	
Max. anschließbare Induktivität $L_o$								
IIC	66 mH	50 mH	20 mH	5 mH	1 mH	0,5 mH	0,2 mH	
IIB / IIIC	100 mH	20 mH	5 mH	1 mH	0,5 mH	0,2 mH	0,1 mH	

7 Transport und Lagerung

- Gerät nur in Originalverpackung transportieren und lagern.
- Gerät trocken (keine Betauung) und erschütterungsfrei lagern.
- Gerät nicht stürzen.

## 8 Montage und Installation

Das Gerät ist für den Einsatz in gasexplosionsgefährdeten Bereichen der Zone 2, in staubexplosionsgefährdeten Bereichen der Zone 22 sowie auch im sicheren Bereich zugelassen.



Wenn in der Anlage starke elektromagnetische Störquellen vorhanden sind oder die Leitungen länger als 30 m sind, wird empfohlen, geschirmte Feldkabel zu verwenden, um die spezifizierte Genauigkeit zu erreichen. Der Schirm muss dann mit dem Potentialausgleich des explosionsgefährdeten Bereichs verbunden und möglichst nahe der Eintrittsstelle auf den Schirmschienen im Gehäuse aufgelegt werden! Die Schirmschienen sind ebenfalls nahe der Eintrittsstelle der Feldverkabelung auf möglichst kurzem Weg mit der Montageplatte zu verbinden!  
Anleitung "Erdung und Schirmung" beachten!

### 8.1 Maßangaben / Befestigungsmaße

Maßzeichnungen (alle Maße in mm [Zoll]) – Änderungen vorbehalten

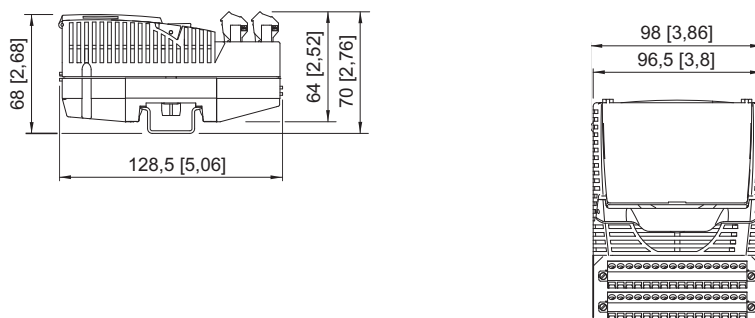

15254E00

### 8.2 Montage / Demontage, Gebrauchslage

#### 8.2.1 Montage / Demontage auf BusRail

#### **HINWEIS**

Fehlfunktion oder Geräteschaden durch unsachgemäße Montage.

Nichtbeachten kann Sachschaden verursachen!

- Gerät nur in vertikaler oder horizontaler Lage montieren und betreiben!  
(Orientierung horizontal: Lese-Richtung von unten)

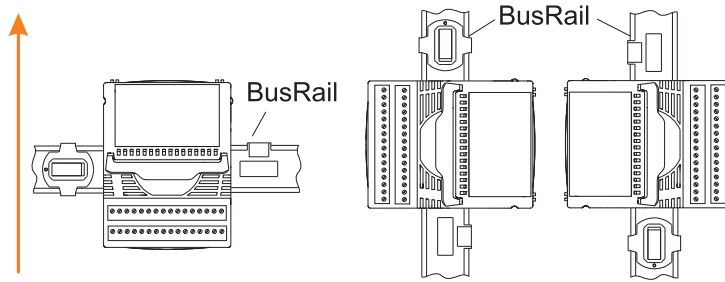

2073E00

## Montage auf BusRail

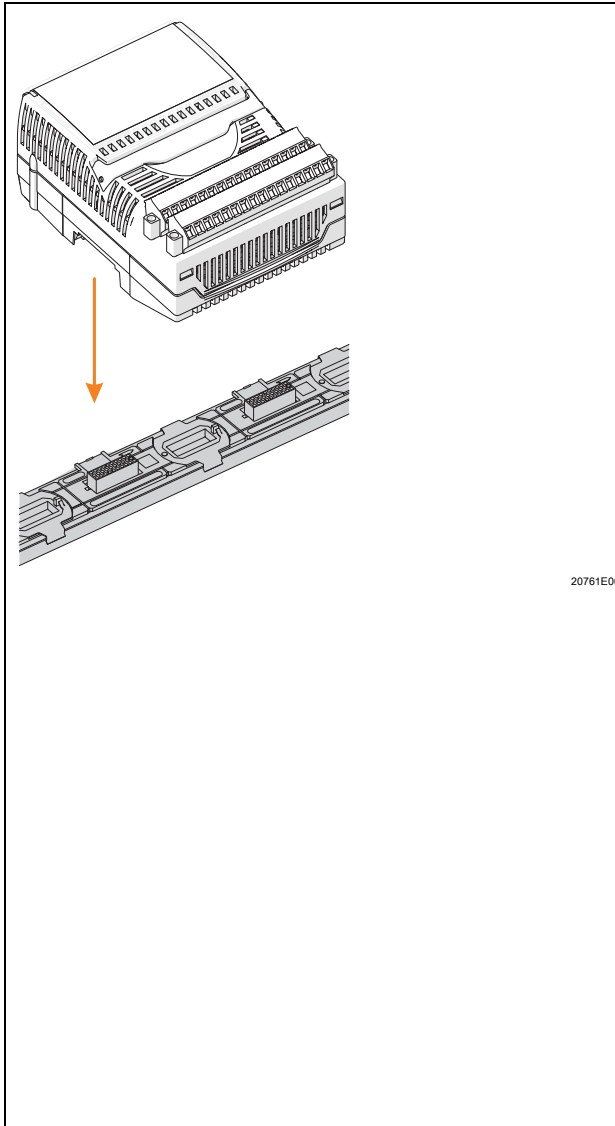

- Modul senkrecht auf vorgesehenen Steckplatz der BusRail aufsetzen und durch leichtes Drücken einrasten.
- Um sicherzustellen, dass das Modul richtig eingerastet ist, nochmals links und rechts das Modul auf die BusRail drücken!

Zwischen Modul und BusRail sollte keine Lücke sein!

Modul darf sich ohne Betätigen des Griffs nicht mehr lösen lassen.

- Steckbare Klemme X1 und X2 auf Modul stecken und mit den Sicherungsschrauben gegen Lockern sichern (Anzugsdrehmoment 0,5 ... 0,6 Nm).
  - Um den Abstand von mind. 50 mm zwischen eigensicheren und nicht-eigensicheren Stromkreisen zu gewährleisten, gegebenenfalls Trennwand (220101) auf benachbartes Ex i Modul montieren oder Leerplatz zwischen Ex i und nicht Ex i Modulen vorsehen.
- Hinweis:**  
Trennwand kann ausschließlich auf Ex i Modulen montiert werden.  
Wenn das Ex i Modul 2 Klemmreihen besitzt, muss die Trennwand noch bearbeitet werden (Sollbruchstelle).



## 8.2.2 Voraussetzungen für Demontage / Modulwechsel

Vor der Demontage bzw. dem Wechsel des Moduls Folgendes beachten:

- Bei Betrieb im Nicht Ex Bereich ist ein Stecken/Ziehen der Klemmen X1, X2 jederzeit funktionell möglich. Ebenfalls darf auch das Modul auf die BusRail gesteckt oder abgezogen werden (Hot Swap).
- Das Modul ohne angeschlossene bzw. spannungslose Feldkabel darf im Ex-Bereich auf die BusRail gesteckt oder von ihr gezogen werden.
- Bei Betrieb im Ex Bereich dürfen die steckbaren Feldkabelanschlüsse X1, X2 nur spannungslos gesteckt oder gezogen werden! Alle an die Klemmen X1 und X2 angeschlossenen Stromkreise sind daher zuvor spannungsfrei zu schalten!

### Demontage

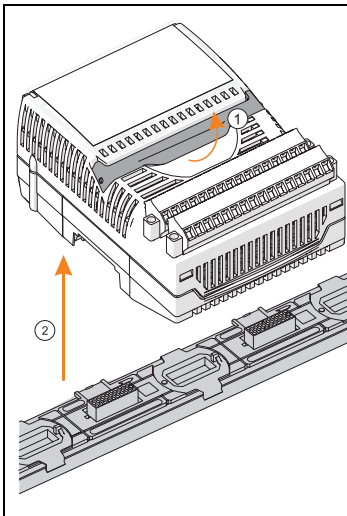

- Schrauben der steckbaren Klemmen X1 und X2 lösen.
- Steckbare Klemme X1 und X2 vom auszutauschenden Modul abziehen.
- Blauen Rasthebel des Moduls nach oben ziehen (1), um das Modul zu entriegeln.
- Modul senkrecht von BusRail abziehen (2).

20762E00

### Modulwechsel (nach Demontage)

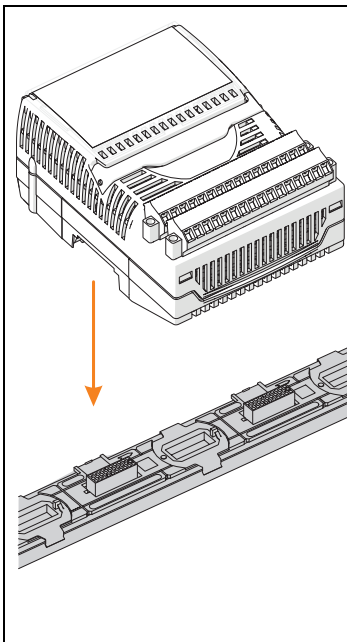

- Neues Modul senkrecht auf vorgesehenen Steckplatz der BusRail aufsetzen und durch leichtes Drücken einrasten.
- Um sicherzustellen, dass das Modul richtig eingerastet ist, nochmals links und rechts das Modul auf die BusRail drücken. Dabei prüfen: Zwischen Modul und BusRail sollte keine Lücke sein! Das Modul darf sich ohne Betätigen des Rasthebels nicht mehr lösen lassen!
- Steckbare Klemmen X1 und X2 auf Modul stecken und mit Schrauben gegen Lockern sichern (Anzugsdrehmoment 0,5 ... 0,6 Nm).

20761E00

## Austausch von Modulen

<b>i</b>	Beim Austausch des Moduls durch ein baugleiches Modul werden die eingestellten Parameter übernommen. Es sind keine weiteren Einstellungen notwendig. Beim Austausch des Moduls durch ein Modul mit anderer Funktion meldet das Modul einen Konfigurationsfehler (rote LED "ERR" blinkt). Das Modul muss entweder neu parametrierter werden oder es muss ein Modul des richtigen Typs verwendet werden.
----------	--

Bei Ersatz eines IS1 Moduls 9480/12 bzw. 9481/12 durch ein funktionsgleiches IS1+ Modul 9482/32 Folgendes beachten:

- Sicherstellen, dass die Anschlussbelegung auf die des 9482/32 angepasst wird.
- Um die neuen IS1+-Funktionen zu nutzen, gegebenenfalls die Firmware des CPM 9440 bzw. der CPU 9441 aktualisieren.
- Bei PROFIBUS-DP-Betrieb gegebenenfalls eine neue GSD verwenden.
- Für weitere Informationen bitte an zuständige Vertriebsstelle wenden.

## 8.3 Installation

<b>i</b>	Bei Betrieb unter erschwerten Bedingungen wie insbesondere auf Schiffen sind zusätzliche Maßnahmen zur korrekten Installation je nach Einsatzort zu treffen. Weitere Informationen und Anweisungen hierzu erhalten Sie gerne auf Anfrage von Ihrem zuständigen Vertriebskontakt.
----------	--

In der Abdeckklappe befindet sich ein Einlegeschild, in das die Zuordnung der Feldgeräte zu den Kanälen eingetragen werden kann. Die Beschriftung des Einlegeschildes kann z.B. über IS Wizard erfolgen.

- Feldgeräte an steckbaren Klemmen X1 und X2 gemäß Anschlussbelegung (siehe Kapitel "Projektierung" oder Einlegeschild unter Abdeckung) anschließen.
- Schirme der Feldverkabelung (falls vorhanden) möglichst nahe der Eintrittsstelle am Feldgehäuse auf die Erdungsschiene auflegen.
- Gegebenenfalls Trennwand auf das benachbarte Ex i Modul einrasten.
- Steckbare Klemmen X1 und X2 auf Modul stecken und mit Schrauben gegen Lockern sichern (Anzugsdrehmoment 0,5 ... 0,6 Nm).

<b>i</b>	Das Modul und die steckbaren Klemmen X1 und X2 können während des Betriebs im explosionsgefährdeten Bereich gefahrlos gesteckt oder gezogen werden (hot-swap).
----------	--

## 9 Inbetriebnahme

Vor Inbetriebnahme Folgendes sicherstellen:

- Vorschriftsmäßige Installation des Gerätes.
- Richtiger Anschluss der Kabel.
- Keine Schäden am Gerät und an Anschlusskabeln.
- Fester Sitz der Schrauben an den Klemmen.  
Richtiges Anzugsdrehmoment: 0,5 ... 0,6 Nm.

### 9.1 Abgleich für 2-Leiter-Widerstandsthermometer

- TIM 9482 konfigurieren, Kanal auf "2 Leiter (R in  $\Omega$ )" und Remote I/O in Betrieb setzen (LED "RUN", grün am I/O-Modul = EIN).
- Sensor am Anschlusskabel des abzugleichenden Kanals in der Nähe des Sensors für ca. 10 Sekunden (min. 6, max. 14 Sek) kurzschließen.
- Während des Abgleichs auf niederohmigen Kurzschluss am Leitungsende achten. (Leitungswiderstand kleiner 15  $\Omega$  und Diagnose zeigt Kurzschluss an).
- Nach beseitigtem Kurzschluss korrekte Funktion der Messstelle prüfen. Wird nachfolgend ein Signalfehler am I/O-Modul angezeigt (LED "ERR", rot am I/O-Modul = EIN) und im Automatisierungssystem "Fehler 2-Leiter-Abgleich (2 wire calibration failed)" gemeldet, dann wurde der 2-Leiter-Abgleich fehlerhaft beendet.
- Neuen Abgleich durchführen.

Abgleich für Pt100 GOST, M50 GOST, M100 GOST, Cu53 GOST, Pt46 GOST, Pt50 GOST und Widerstandsmessung

- Zuerst auf Pt1000 einstellen, dann Abgleich durchführen und wieder zurück zu dem gewünschten Sensor. Ein einmal ermittelter Wert für den Leitungswiderstand bei 2-Leiter ist für jeden Kanal gespeichert.

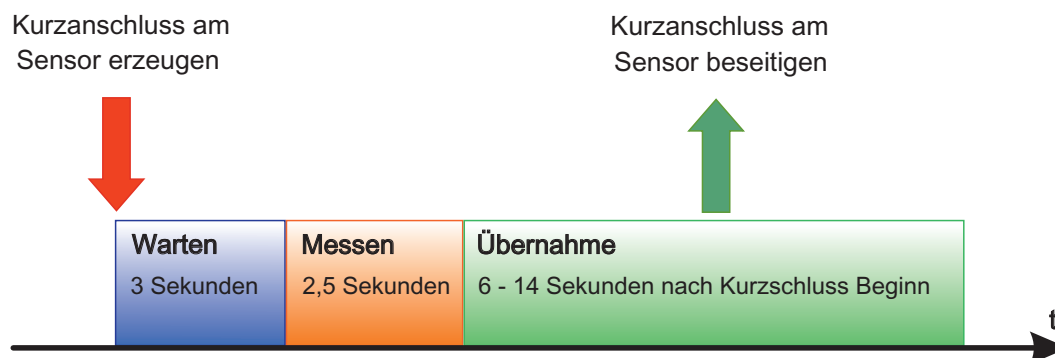

16557E01

## 9.2 Potentiometer im Betrieb "4 Leiter schnell" (Joystick)

In dieser Betriebsart werden sehr kurze Signalverzögerungen erreicht, wodurch spezielle Applikationen wie z.B. Joystick möglich sind.

- TIM 9482 konfigurieren
- Modul Betriebsart auf "4 Kanal R schnell" setzen.
- Kanal auf Schaltungsart "4 Leiter" setzen.
- Kanal unter Typ Eingang den gewünschten Widerstand auswählen.

Bei 4-Leiter-Betrieb mit Potentiometer (Joystick) können nur die ersten 4 Kanäle (0-3) betrieben werden.

Schematisch	
	4-Leiter Joystick
Kanal	X1-Klemmen
0	1 (I+), 2 (V+), 3 (V-), 4 (I-)
1	5 (I+), 6 (V+), 7 (V-), 8 (I-)
2	9 (I+), 10 (V+), 11 (V-), 12 (I-)
3	13 (I+), 14 (V+), 15 (V-), 16 (I-)

## 10 Betrieb

### 10.1 Anzeige

Entsprechende LEDs am Gerät zeigen den Betriebszustand des Geräts an (siehe auch Kapitel "Funktion und Geräteaufbau").

LED	Farbe	Bedeutung
LED "RUN"	grün	Betriebsanzeige: Gerät läuft störungsfrei
LED "ERR"	rot	Anzeige Modulfehler
LED "M/S"	blau	Wartungsbedarf oder außerhalb Spezifikation

## 10.2 Fehlerbeseitigung

Bei der Fehlerbeseitigung folgenden Fehlersuchplan beachten:

Fehler	Fehlerursache	Fehlerbehebung
LED "RUN" blinkt	Modul ist in Ordnung, jedoch noch nicht für den zyklischen Datenaustausch bereit (es ist noch kein Parametersatz vorhanden). Ausgänge in leistungslosem Zustand	<ul style="list-style-type: none"> <li>• Zyklischen Datenverkehr mit dem Master in Betrieb setzen</li> <li>• Master, Busverbindung und CPM oder CPU und PM prüfen</li> </ul>
LED "RUN" erloschen	<ul style="list-style-type: none"> <li>• Keine Versorgungsspannung am I/O-Modul vorhanden</li> <li>• I/O-Modul defekt</li> </ul>	<ul style="list-style-type: none"> <li>• System-Versorgung prüfen</li> <li>• CPM oder CPU und PM prüfen</li> <li>• BusRail prüfen</li> <li>• I/O-Modul richtig auf die BusRail aufrasten</li> <li>• I/O-Modul tauschen</li> </ul>
LED "ERR" blinkt	<ul style="list-style-type: none"> <li>• Fehler im Feldstromkreis</li> <li>• Leitungsbruch oder Kurzschluss</li> <li>• Messbereichsüber-/unterschreitung</li> </ul>	<ul style="list-style-type: none"> <li>• Signal-LEDs "rot" prüfen</li> <li>• Ursache im angezeigten Feldstromkreis beseitigen, Leitungen und Feldgeräte überprüfen</li> </ul>
	Konfiguration ist nicht in Ordnung oder falsches Modul ist gesteckt	Konfiguration im Automatisierungssystem ändern oder richtiges Modul stecken
	Zyklischer Datenverkehr mit dem Automatisierungssystem unterbrochen	<ul style="list-style-type: none"> <li>• CPM bzw. CPU auf zyklischen Datenverkehr überprüfen (LCD bzw. LED "RUN")</li> <li>• Busverbindung prüfen</li> <li>• Zyklischen Datenverkehr mit dem Automatisierungssystem in Betrieb setzen</li> </ul>
LED "ERR" leuchtet	Modul defekt	Modul austauschen
LED "M/S" blinkt	Umgebungstemperatur außerhalb der Spezifikation	Umgebungstemperatur verringern durch z.B.: Beschattung oder Kühlung <b>Hinweis: Ohne Behebung wird das Modul dauerhaft geschädigt</b>
LED "M/S" leuchtet	Steckplatzfehler oder Modul geschädigt durch Übertemperatur oder Ende der Lebensdauer erreicht	Modul baldmöglichst (innerhalb der nächsten 12 Monate) tauschen, sonst droht Modulausfall

Wenn sich der Fehler mit den genannten Vorgehensweisen nicht beheben lässt:

- An R. STAHL Schaltgeräte GmbH wenden.

Zur schnellen Bearbeitung folgende Angaben bereithalten:

- Typ und Seriennummer des Geräts
- DCS/SPS
- Protokoll
- Revisions-Nr/Firmware-Version
- Kaufdaten
- Fehlerbeschreibung
- Einsatzzweck (insbesondere Eingangs-/Ausgangsbeschaltung)

## 11 Instandhaltung, Wartung, Reparatur

### 11.1 Instandhaltung



- Art und Umfang der Prüfungen den entsprechenden nationalen Vorschriften entnehmen.
- Prüfungsintervalle an Betriebsbedingungen anpassen.

Bei der Instandhaltung des Geräts mindestens folgende Punkte prüfen:

- fester Sitz der untergeklemmten Leitungen,
- Rissbildung und andere sichtbare Schäden am Gerätegehäuse und / oder Schutzgehäuse,
- Einhaltung der zulässigen Umgebungstemperaturen,
- Bestimmungsgemäße Funktion.

### 11.2 Wartung

Das Gerät benötigt keine regelmäßige Wartung.

	Wenn die blaue LED "M/S" kontinuierlich leuchtet, wird empfohlen, das Modul in absehbarer Zeit auszutauschen. Ansonsten steigt nach 12 Monaten die Ausfallwahrscheinlichkeit an (siehe Kapitel "Anzeigen" und "Fehlerbeseitigung").
	Die geltenden nationalen Bestimmungen im Einsatzland beachten.

### 11.3 Reparatur

	<b>GEFAHR</b>
	Explosionsgefahr durch unsachgemäße Reparatur! Nichtbeachten führt zu schweren oder tödlichen Verletzungen. <ul style="list-style-type: none"> <li>• Reparaturen an den Geräten ausschließlich durch R. STAHL Schaltgeräte GmbH ausführen lassen.</li> </ul>

## 11.4 Rücksendung

- Rücksendung bzw. Verpackung der Geräte nur in Absprache mit R. STAHL durchführen! Dazu mit der zuständigen Vertretung von R. STAHL Kontakt aufnehmen.

Für die Rücksendung im Reparatur- bzw. Servicefall steht der Kundenservice von R. STAHL zur Verfügung.

- Kundenservice persönlich kontaktieren.

oder

- Internetseite r-stahl.com aufrufen.
- Unter "Support" > "RMA Formular" > "RMA-Schein anfordern" wählen.
- Formular ausfüllen und absenden.  
Sie erhalten per E-Mail automatisch einen RMA-Schein zugeschickt.  
Bitte drucken Sie diese Datei aus.
- Gerät zusammen mit dem RMA-Schein in der Verpackung an die R. STAHL Schaltgeräte GmbH senden (Adresse siehe Kapitel 1.1).

## 12 Reinigung

- Zur Vermeidung elektrostatischer Aufladung dürfen die Geräte in explosionsgefährdeten Bereichen nur mit einem feuchten Tuch gereinigt werden.
- Bei feuchter Reinigung: Wasser oder milde, nicht scheuernde, nicht kratzende Reinigungsmittel verwenden.
- Keine aggressiven Reinigungsmittel oder Lösungsmittel verwenden.

## 13 Entsorgung

- Nationale und lokal gültige Vorschriften und gesetzliche Bestimmungen zur Entsorgung beachten.
- Materialien getrennt dem Recycling zuführen.
- Umweltgerechte Entsorgung aller Bauteile gemäß den gesetzlichen Bestimmungen sicherstellen.

## 14 Zubehör und Ersatzteile

### HINWEIS

Fehlfunktion oder Geräteschaden durch den Einsatz nicht originaler Bauteile.  
Nichtbeachten kann Sachschaden verursachen!

- Nur Original-Zubehör und Original-Ersatzteile der R. STAHL Schaltgeräte GmbH verwenden.



Zubehör und Ersatzteile, siehe Datenblatt auf Homepage r-stahl.com.





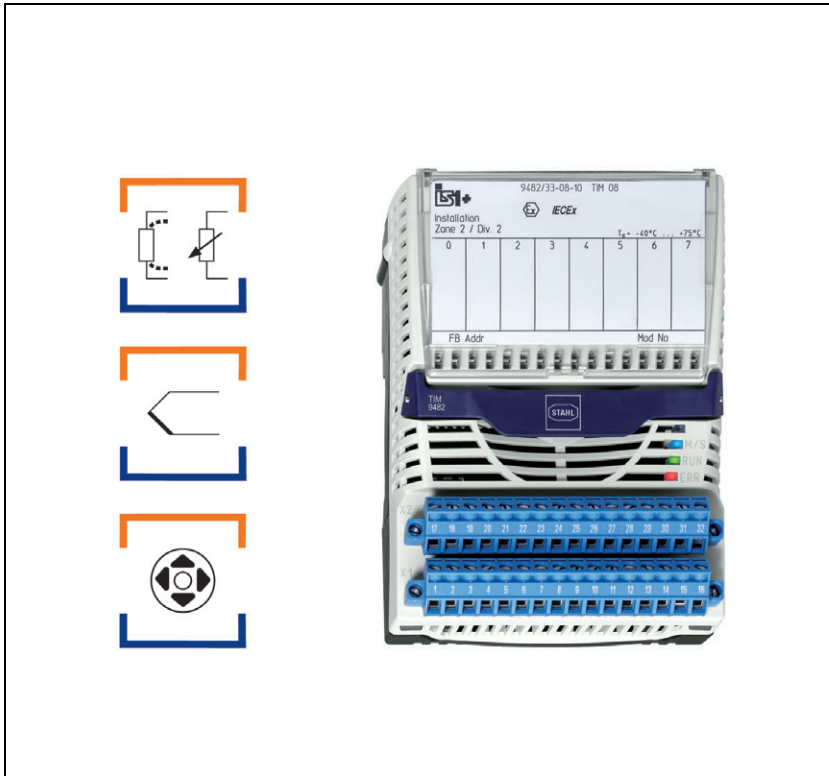

## Temperature Input Module for Zone 2 / Div. 2

Series 9482/33



## Contents

1	General Information .....	3
1.1	Manufacturer .....	3
1.2	Information regarding the Operating Instructions .....	3
1.3	Further Documents .....	3
1.4	Conformity with Standards and Regulations .....	3
2	Explanation of the Symbols .....	3
2.1	Symbols in these Operating Instructions .....	3
2.2	Warning Notes .....	4
2.3	Symbols on the Device .....	4
3	Safety Notes .....	5
3.1	Operating Instructions Storage .....	5
3.2	Personnel Qualification .....	5
3.3	Safe Use .....	5
3.4	Modifications and Alterations .....	6
4	Function and Device Design .....	7
4.1	Function .....	7
4.2	Device Design .....	8
5	Technical Data .....	9
6	Engineering .....	16
6.1	Terminal Assignment of the pluggable Terminals X1 and X2 .....	17
6.2	Line Fault Suppression .....	18
6.3	Connection Example .....	19
6.4	Proof of Intrinsic Safety .....	19
7	Transport and Storage .....	30
8	Mounting and Installation .....	31
8.1	Dimensions / Fastening Dimensions .....	31
8.2	Mounting / Dismounting, Operating Position .....	31
8.3	Installation .....	34
9	Commissioning .....	35
9.1	Compensation for 2-Wire Resistance Temperature Detector .....	35
9.2	Potentiometer in quick 4-Wire Operation (Joystick) .....	36
10	Operation .....	36
10.1	Indication .....	36
10.2	Troubleshooting .....	37
11	Maintenance, Overhaul, Repair .....	38
11.1	Maintenance .....	38
11.2	Overhaul .....	38
11.3	Repair .....	38
11.4	Returning the Device .....	39
12	Cleaning .....	39
13	Disposal .....	39
14	Accessories and Spare Parts .....	39

## 1 General Information

### 1.1 Manufacturer

R. STAHL Schaltgeräte GmbH  
Am Bahnhof 30  
74638 Waldenburg  
Germany

Phone: +49 7942 943-0  
Fax: +49 7942 943-4333  
Internet: r-stahl.com  
E-Mail: info@r-stahl.com

### 1.2 Information regarding the Operating Instructions

ID-No.: 218150 / 948260310020  
Publication Code: 2020-10-02-BA00-III-en-03

The original instructions are the English edition.  
They are legally binding in all legal affairs.

### 1.3 Further Documents

- IS1+ coupling description (download from r-stahl.com)
- "Earthing and shielding" instructions (download from r-stahl.com)
- Data sheet

For documents in additional languages, see r-stahl.com.

### 1.4 Conformity with Standards and Regulations



See certificates and EU Declaration of Conformity: r-stahl.com.

The device has IECEx approval. For certificate please refer to the IECEx homepage:  
<http://iecex.iec.ch/>

Further national certificates can be downloaded via the following link:  
<https://r-stahl.com/en/global/support/downloads/>.

## 2 Explanation of the Symbols



### 2.1 Symbols in these Operating Instructions

Symbol	Meaning
	Tips and recommendations on the use of the device
	Danger due to explosive atmosphere





## 2.2 Warning Notes

Warnings must be observed under all circumstances, in order to minimize the risk due to construction and operation. The warning notes have the following structure:

- Signalling word: DANGER, WARNING, CAUTION, NOTICE
- Type and source of danger/damage
- Consequences of danger
- Taking countermeasures to avoid the danger or damage

	<b>DANGER</b>
	Danger to persons Non-compliance with the instruction results in severe or fatal injuries to persons.
	<b>WARNING</b>
	Danger to persons Non-compliance with the instruction can result in severe or fatal injuries to persons.
	<b>CAUTION</b>
	Danger to persons Non-compliance with the instruction can result in light injuries to persons.
<b>NOTICE</b>	
Avoiding material damage Non-compliance with the instruction can result in material damage to the device and / or its environment.	

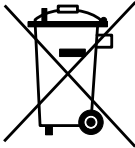
## 2.3 Symbols on the Device

Symbol	Meaning
 <small>05594E00</small>	CE marking according to the current applicable directive.
 <small>02198E00</small>	Electric circuit certified for hazardous areas according to the marking.
 <small>11048E00</small>	Safety instructions that must always be followed: The respective data must be noted and/or the safety-related instructions contained in the operating instructions must be followed for devices with this symbol!
  <small>20690E00</small>	Marking according to the WEEE directive 2012/19/EU

## 3 Safety Notes

### 3.1 Operating Instructions Storage

- Read the operating instructions carefully.
- Store the operating instructions at the mounting location of the device.
- Observe applicable documents and operating instructions of the devices to be connected.

### 3.2 Personnel Qualification

Qualified specialist personnel are required to perform the tasks described in these operating instructions. This primarily applies to work in the following areas

- Project engineering
- Mounting/dismounting the device
- (Electrical) Installation
- Commissioning
- Maintenance, repair, cleaning

Specialists who perform these tasks must have a level of knowledge that meets applicable national standards and regulations.

Additional knowledge is required for tasks in hazardous areas! R. STAHL recommends having a level of knowledge equal to that described in the following standards:

- IEC/EN 60079-14 (Electrical installations design, selection and construction)
- IEC/EN 60079-17 (Inspection and maintenance of electrical installations)
- IEC/EN 60079-19 (Equipment repair, overhaul and reclamation)

### 3.3 Safe Use

#### Before mounting

- Read and observe the safety notes in these operating instructions!
- Ensure that the contents of these operating instructions are fully understood by the personnel in charge.
- Use the device in accordance with its intended and approved purpose only.
- Always consult with R. STAHL Schaltgeräte GmbH if using the device under operating conditions which are not covered by the technical data.
- Make sure that the device is not damaged.
- We cannot be held liable for damage at the device caused by incorrect or unauthorised use or non-compliance with these operating instructions.

#### For mounting and installation



- Have mounting and installation performed only by qualified and authorised persons (see chapter "Qualification of the personnel").
- The device is only to be installed in areas for which it is suited based on its marking.
- During installation and operation, observe the information (characteristic values and rated operating conditions) on the rating, data and information plates located on the device.
- Before installation, make sure that the device is not damaged.

- Electrical circuits with the "Ex i" type of protection can no longer be operated as circuits with this protection type after being operated with circuits with other types of protection.
- When used in Zone 2 or Zone 22, the device is to be installed in a protective enclosure or in a cabinet that offers a suitable degree of protection in accordance with IEC/EN 60079-0.
- An enclosure with at least an IP54 protection rating is required for use in Zone 2 and in safe areas.
- An enclosure with at least an IP64 protection rating in accordance with IEC/EN 60079-31 is required for use in Zone 22.
- The module may only be mounted on the BusRail 9494.
- Modules with intrinsically safe and non-intrinsically safe field circuits may be operated simultaneously on one BusRail. In this case, a distance of 50 mm must be maintained between the terminals with intrinsically safe and those with non-intrinsically safe field circuits (e.g. partition 220101 or empty space).
- Interconnection of several active, intrinsically safe field circuits can result in deviating safety-related maximum values. This may endanger intrinsic safety such that corresponding verification needs to be provided.
- The safety-related maximum values of the connected field devices must match the values of the modules according to the data sheet, operating instructions or EU Type Examination Certificate and certificates.

**Commissioning, maintenance, repair**

- Only have commissioning and repairs performed by qualified and authorised persons (see chapter "Personnel qualification").
- Before commissioning, make sure that the device is not damaged.
- Perform only maintenance work described in these operating instructions.
- Modules and plug connectors may be connected and disconnected during operation in hazardous areas (hot swap and hot plug).
- Always clean the device with a damp cloth to prevent electrostatic charge.

**3.4 Modifications and Alterations**

	DANGER
	<p>Explosion hazard due to modifications and alterations to the device!                  Non-compliance results in severe or fatal injuries.</p> <ul style="list-style-type: none"> <li>• Do not modify or alter the device.</li> </ul>
	<p>No liability or warranty for damage resulting from modifications and alterations.</p>

## 4 Function and Device Design

	DANGER
	<p>Explosion hazard due to improper use! Non-compliance results in severe or fatal injuries.</p> <ul style="list-style-type: none"> <li>• Use the device only in accordance with the operating conditions described in these operating instructions.</li> <li>• Use the device only for the intended purpose specified in these operating instructions.</li> </ul>

### 4.1 Function

#### Application range

The type 9482/33 temperature input module is used to connect up to 8 intrinsically safe temperature sensors to the remote I/O system IS1+.

The temperature input module is approved for use in gas explosion hazardous areas of Zone 2, dust explosion hazardous areas of Zone 22 and in safe areas.

#### Mode of operation

Each channel can be used as input for resistance temperature detectors and potentiometers in 2, 3 or 4-wire technology or thermocouples and mV transmitters. When using resistance temperature detectors or potentiometers, the line compensation for a 2-conductor circuit can be performed by means of the keyboard or display of the corresponding CPU and power module (CPM or CPU and PM) or automatically via the module.

The "4 channel fast" operating mode (adjustable parameters) achieves very short signal delays, which allows for special applications, such as joystick applications.

If thermocouples or mV transmitters are used, the reference junction temperature can be compensated internally at the connection terminals or optionally via the external reference junction (CJC) connected to channel 6 and 7 or via a resistance temperature detector.

Each input is individually monitored for wire breakage and short circuit.

The interface of the Temperature Input Module to the internal data bus of the BusRail is designed redundantly.

	<p>Function-compatible replacement for IS1 I/O modules: Series 9480/12 and 9481/12.</p>
---	---

## 4.2 Device Design

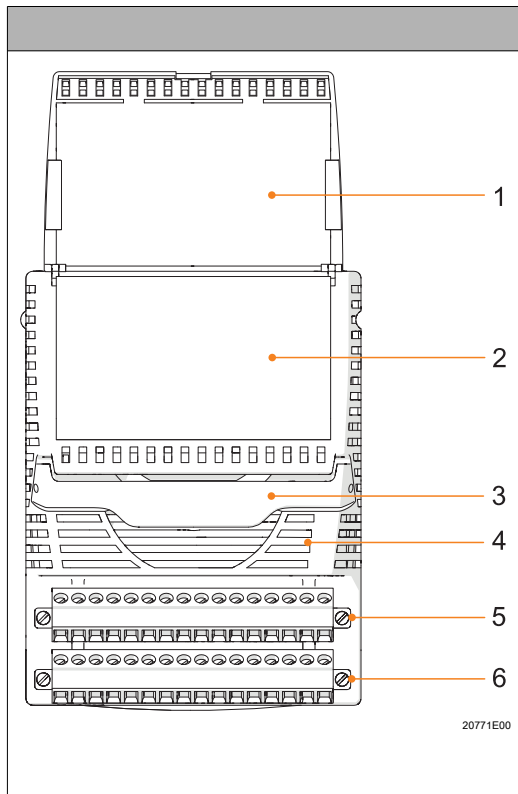

#	Device component	Description
1	Cover flap	Cover flap with insert disc and connection diagram (open)
2	Labelling	Module data (serial number, hardware revision number, software revision number, date of manufacture, e.g.: 12345678914-004 Rev.A 01-01 0514)
3	Notch lever	Notch lever for removing the module from the BusRail
4	LED	LED for indication Maintenance ("M/S", blue), operation ("RUN", green) and error ("ERR", red) (for further information, see "Indication" chapter)
5	Terminal	Pluggable terminal X2 with two safety screws
6	Terminal	Pluggable terminal X1 with two safety screws

20771E00



## 5 Technical Data

### Explosion Protection

#### Global (IECEX)

Gas and dust	IECEX DEK 13.0046X Ex ec ia [ia Ga] IIC T4 Gc [Ex ia Da] IIIC
--------------	---

#### Europe (ATEX)

Gas and dust	DEKRA 13 ATEX 0140 X ⊕ II 3 (1) G Ex ec ia [ia Ga] IIC T4 Gc ⊕ II (1) D [Ex ia Da] IIIC
--------------	---

#### Certifications and certificates

Certificates	IECEX, ATEX, Brazil (INMETRO), India (PESO), Canada (cFM), EAC (Eurasian Economic Union), USA (FM)
Ship approval	EU RO Mutual Recognition (incl. ABS, BV, CCS, CRS, DNV GL, IRS, KR, LR, ClassNK, PRS, RINA, RS)

#### Further parameters

Installation	in Zone 2, Zone 22 and in the safe area
Further information	see respective certificate and operating instructions

#### Safety data

Note	See chapter "Documentation of intrinsic safety"
Max. internal capacity $C_i$	negligible
Max. internal inductance $L_i$	negligible

### Technical Data

#### Electrical data

Ex i inputs	
Resistance temperature detector / resistance transmitter	
Number of channels	8
Operating modes	8 channel precise/ 4 channel fast (joystick)
Connection type	2-, 3- and 4-wire circuits
Resistance range	0 to 10 k $\Omega$
Measuring current	< 200 $\mu$ A multiplexed
Max. line resistance per cable	100 $\Omega$
Measurement accuracy	0.025 % (8 channel precise) / $\pm$ 1 % (4 channel fast joystick)
Note	All values in % of measuring range at 23 °C

**Technical Data**

Ambient temperature influence

0.025 % / 10 K

Linearity (adjustable parameters)

Temperature linear / resistance linear

Connectable resistance temperature detectors / resistance transmitters

Type	Reference	Measuring range (ITS-90)	Medium resolution
Pt100	IEC 60751	-200 to +850 °C	0.1 K
Pt500	IEC 60751	-200 to +850 °C	0.1 K
Pt1000	IEC 60751	-200 to +850 °C	0.1 K
Ni100	DIN 43760	-60 to +180 °C	0.1 K
Ni500	DIN 43760	-60 to +180 °C	0.1 K
Ni1000	DIN 43760	-60 to +180 °C	0.1 K
Pt46	GOST 6651-94	-200 to +1100 °C	0.15 K
Pt50	GOST 6651-94	-200 to +1100 °C	0.15 K
Pt100	GOST 6651-94	-200 to +1100 °C	0.1 K
Cu53	GOST 6651-94	-50 to +180 °C	0.1 K
M50	GOST 6651-94	-200 to +200 °C	0.15 K
M100	GOST 6651-94	-200 to +200 °C	0.1 K
Resistance transmitter (3-conductor)	–	0 to 500 Ω	0.02 Ω
Resistance transmitter (3-conductor)	–	0 to 2.5 kΩ	0.10 Ω
Resistance transmitter (3-conductor)	–	0 to 5 kΩ	0.20 Ω
Resistance transmitter (3-conductor)	–	0 to 10 kΩ	0.4 Ω
Joystick (4-conductor)	–	500 to 10 kΩ	

Technical Data

Reaction time	Type	Type of connection	Operating mode 4 channel fast Error control		Operating mode 8 channel accurate Error control	
			Activated	Deactiva- ted	Activated	Deactiva- ted
			RTD	2-conductor	400 ms	400 ms
RTD	3-conductor	400 ms	400 ms	750 ms	720 ms	
RTD	4-conductor	400 ms	400 ms	750 ms	720 ms	
R	2-conductor in R	400 ms	400 ms	750 ms	720 ms	
R	3-conductor in %	90 ms	70 ms	750 ms	720 ms	
R	4-conductor in R	400 ms	400 ms	750 ms	720 ms	
R	4-conductor in %	90 ms	70 ms	750 ms	720 ms	

To achieve the times with "error control deactivated", the error control must be "OFF" for all channels! As soon as the error control is "ON" for just one channel, the times for "error control activated" apply.

Thermocouples / mV sensors				
Number of channels	8			
Operating modes	8 channel precise/4 channel fast			
Connection type	2-wire circuits			
Signal range	-10 to +100 mV			
Linearity (adjustable parameters)	Temperature linear / voltage linear			
Note	All values in % of the measuring range at 23 °C			
Connectable thermocouples / mV sensors				
Type	Reference	Measuring range (ITS-90)	Medium resolution	Medium error of measurement with regard to measuring range
B	IEC 60584-1	+400 to +1800 °C	0.25 K	0.1 %
E	IEC 60584-1	-200 to +1000 °C	0.1 K	0.013 %
J	IEC 60584-1	-200 to +1200 °C	0.1 K	0.014 %
K	IEC 60584-1	-200 to +1370 °C	0.1 K	0.02 %
N	IEC 60584-1	-200 to +1300 °C	0.1 K	0.02 %
R	IEC 60584-1	-50 to +1767 °C	0.2 K	0.05 %
S	IEC 60584-1	-50 to +1767 °C	0.2 K	0.053 %
T	IEC 60584-1	-200 to +400 °C	0.1 K	0.042 %
L	DIN 43710	-200 to +900 °C	0.1 K	0.027 %
U	DIN 43710	-200 to +600 °C	0.1 K	0.038 %
XK	GOST 8.585	-50 to +800 °C	0.1 K	0.02 %
mV	-	0 to +100 mV	3.6 µV	0.01 %

Technical Data

Reaction time	Type	Type of connection	Operating mode 4 channel fast Error control		Operating mode 8 channel accurate Error control	
			Activated	Deactivated	Activated	Deactivated
	Thermocouple	2-conductor	500 ms	450 ms	800 ms	750 ms
	0 to 100 mV	2-conductor	500 ms	450 ms	800 ms	750 ms
<p>To achieve the times with "error control deactivated", the error control must be "OFF" for all channels! As soon as the error control is "ON" for just one channel, the times for "error control activated" apply.</p>						
Input resistance	10 MΩ					
Ambient temperature influence	0.025 % / 10 K					
Reference junction compensation						
Number of channels	1 (clamping unit see operating instructions)					
Operating modes	internal (adjustable parameters) / external 3-wire circuit					
Connection type	3-wire circuit (external)					
Measuring range	-40 to +80 °C					
Measurement accuracy	internal: 0.025 % / external: depending on sensor type, see "Connectable resistance temperature detectors"					
Resolution	0.1 K					
Temperature deviation for thermocouples with internal compensation	± 2 K					

**Technical Data**

Galvanic separation	
Test voltage	
acc. to standard	EN 60079-11
Between auxiliary power / system components	≥ 1500 V AC
Between two I/O modules	≥ 500 V AC
Between I/O channels / system components	≥ 500 V AC
Between I/O channels / ground (PA)	≥ 500 V AC
Electromagnetic compatibility	
Electromagnetic compatibility	Tested to the following standards and regulations: EN 61326-1, IEC 61000-4-1 to 6, NAMUR NE 21
Measurement accuracy	0.1 % (8 channel precise)
	see also note mounting and installation
Electrical connection	
Power supply	BusRail Types 9494
Ex i field signals	Pluggable, blue terminals, 16-pole, 2.5 mm <sup>2</sup> , screw- or spring-type versions with lock
Auxiliary power	
Maximum power consumption	1 W
Maximum power dissipation	1 W

**Technical Data**

**Device-specific data**

Settings

Module

Diagnostics message	ON / OFF
Operating mode	8 channel precise / 4 channel fast
Selection reference junction	internal / external 3-conductor
Type external reference junction	PT100, PT1000, PT100 GOST

Signal

Behaviour in case of error	hold last value
Error control	ON / OFF
Type of connection	2-, 3-, 4-wire

**Ambient conditions**

Ambient temperature	-40 to +75 °C
Storage temperature	-40 to +80 °C
Maximum relative humidity	95 % (without condensation)
Maximum operating altitude	< 2000 m
Semi-sinusoidal shock (IEC/EN 60068-2-27)	15 g (3 shocks per axis and direction)
Sinusoidal vibration (IEC/EN 60068-2-6)	Frequency range: 2 to 13.2 Hz, amplitude: 1.0 mm (peak value) Frequency range: 13.2 to 100 Hz, acceleration amplitude: 0.7 g

**Mechanical data**

Degree of protection (IEC 60529)	IP20
Module enclosure	polyamide 6GF
Fire resistance (UL 94)	V2
Pollutant class	corresponds to G3
Dimensions	L = 128 mm, W = 96.5 mm, H = 67 mm

**Technical Data**

**Indication**

LED indication	
Module requires maintenance	"M/S" LED, blue
Operating state	"RUN" LED, green
Group error	"ERR" LED, red
Function indication	
Retrievable parameters	Manufacturer, Type, hardware revision, software revision, serial number
Error indication	
Module status and alarms	<ul style="list-style-type: none"> <li>• Internal bus error primer / redundant</li> <li>• No response from IOM</li> <li>• Configuration does not correspond to the module</li> <li>• Hardware error</li> <li>• Excess temperature</li> <li>• Slot error</li> <li>• Module requires maintenance</li> </ul>
Signal errors for each channel	
Signal status bit	"0" = signal interference present; "1" = signal valid
Wire breakage input	Resistance temperature detector / resistance transmitter: > 100 Ω; thermocouples / mV-sensors: > 1000 Ω
Short circuit input	Resistance temperature detector / resistance transmitter: < 15 Ω
Measuring range	Exceeding / shortfall

**Mounting / Installation**

Installation conditions	
Mounting type	On 35 mm DIN rail NS 35/15 (DIN EN 60715)
Mounting orientation	horizontal or vertical (observe operating instructions)

For further technical data, see [r-stahl.com](http://r-stahl.com).

## 6 Engineering

### *NOTICE*

An ambient temperature that is too high may cause failure of the devices installed in the cabinet.

Non-compliance can result in material damage.

- Install and adjust the cabinet in such a way that it is always operated within the permissible temperature range.

The following conditions must be observed during project engineering:

- To ensure adherence with the intended use, only install the device on the IS1 BusRail 9494.
- Operation of the device is only permissible in three approved mounting positions: See chapter "Mounting/dismounting on BusRail".
- Modules with intrinsically safe and non-intrinsically safe field circuits may be operated simultaneously on one BusRail. In this case, a distance of 50 mm must be maintained between the terminals with intrinsically safe field circuits and those with non-intrinsically safe field circuits (e.g. partition 220101 or empty space).



## 6.1 Terminal Assignment of the pluggable Terminals X1 and X2

For the module, two pluggable terminals X1 and X2 (screw terminals 162702 and 162718 or spring clamp terminals 162695 and 162716) for connection of field devices are available as accessories (not included in the scope of delivery of the module!).

The pluggable terminals X1 and X2 have 16 clamping units for connection of the field cables.

Terminal assignment of the pluggable terminals X1 and X2					
	Resistance sensors			Thermocouples and mV transmitters	External reference junction
	 16495E00			 16552E00	 16551E00
	2-conductor	3-conductor	4-conductor	2-conductor	3-conductor
Channel	X1/X2 terminals			X1/X2 terminals	X2 terminals
0	1 (I+), 4 (I-)	1 (I+), 3 (V-), 4 (I-)	1 (I+), 2 (V+), 3 (V-), 4 (I-)	2 (V+), 3 (V-)	–
1	5 (I+), 8 (I-)	5 (I+), 7 (V-), 8 (I-)	5 (I+), 6 (V+), 7 (V-), 8 (I-)	6 (V+), 7 (V-)	–
2	9 (I+), 12 (I-)	9 (I+), 11 (V-), 12 (I-)	9 (I+), 10 (V+), 11 (V-), 12 (I-)	10 (V+), 11 (V-)	–
3	13 (I+), 16 (I-)	13 (I+), 15 (V-), 16 (I-)	13 (I+), 14 (V+), 15 (V-), 16 (I-)	14 (V+), 15 (V-)	–
4	17 (I+), 20 (I-)	17 (I+), 19 (V-), 20 (I-)	17 (I+), 18 (V+), 19 (V-), 20 (I-)	18 (V+), 19 (V-)	–
5	21 (I+), 24 (I-)	21 (I+), 23 (V-), 24 (I-)	21 (I+), 22 (V+), 23 (V-), 24 (I-)	22 (V+), 23 (V-)	–
6	25 (I+), 28 (I-)	25 (I+), 27 (V-), 28 (I-)	25 (I+), 26 (V+), 27 (V-), 28 (I-)	26 (V+), 27 (V-)	25 (I+)
7	29 (I+), 32 (I-)	29 (I+), 31 (V-), 32 (I-)	29 (I+), 30 (V+), 31 (V-), 32 (I-)	30 (V+), 31 (V-)	29 (I+), 32 (I-)

The signal inputs are galvanically connected with each other. Since they are designed as differential inputs, they prevent generation of earth loops for earthed thermocouples.

## 6.2 Line Fault Suppression

Optionally, non-used channels can be wired to resistors for suppressing line fault indications (simple electrical equipment for intrinsically safe circuits in acc. with EN 60079-11).

<b>i</b>	The resistors are available as accessories.
----------	---

Can be equipped as follows based on the signal type, e.g. channel 0:

2-conductor TC/Vm transmitter	62R between clamping unit 2 and 3
2-conductor RTD	62R between clamping unit 1 and 4
3-conductor RTD	62R between clamping unit 2 and 3, where 3 and 4 are bridged
4-conductor RTD	62R between clamping unit 2 and 3, where 1 and 2 as well as 3 and 4 are bridged

### 6.3 Connection Example

Up to 8 thermocouples or mV transmitters as well as resistance temperature detectors and an external reference junction are connected.

A mixture of different signals is possible, for example:

- Thermocouples or mV transmitters on channel 0, 2, 6 and 7
- Resistance temperature detectors or potentiometers on channel 1, 3 and 5
- External reference junction on channel 6 and 7

RTD and potentiometer with thermocouples and mV transmitters with external CJC				
	16497E00			
Chan- nel	Thermocouple / mV sensor	2-conductor RTD	3-conductor RTD	External 3-conductor CJC / 4-conductor RTD
0	2 (V+), 3 (V-)	–	–	–
1	6 (V+), 7 (V-)	–	–	–
2	–	–	9 (I+), 11 (V-), 12 (I-)	–
3	–	13 (I+), 16 (I-)	–	–
4	–	–	–	17 (I+), 18 (V+), 19 (V-), 20 (I-)
5	–	–	–	21 (I+), 22 (V+), 23 (V-), 24 (I-)
6	26 (V+), 27 (V-)	–	–	25 (I+), 29 (I+), 32 (I-)
7	30 (V+), 31 (V-)	–	–	
<b>i</b>	The safety data of the connection example are determined depending on the combination of connection !!			

### 6.4 Proof of Intrinsic Safety

To verify the intrinsic safety, the safety data according to the sensor, sensor combination and circuitry used are displayed. For all sensors used, the safety data of the sensor circuitry indicated below must be taken into account: the module supports the different temperature sensors (resistance temperature detectors, resistance transmitters, thermocouples and mV transmitters) with pure or mixed circuitry. Depending on the circuitry, the safety data for the respective measurement channel may vary.

The flow chart will help you select the correct safety data.

6.4.1 Flow Chart for Selection of the Safety Data

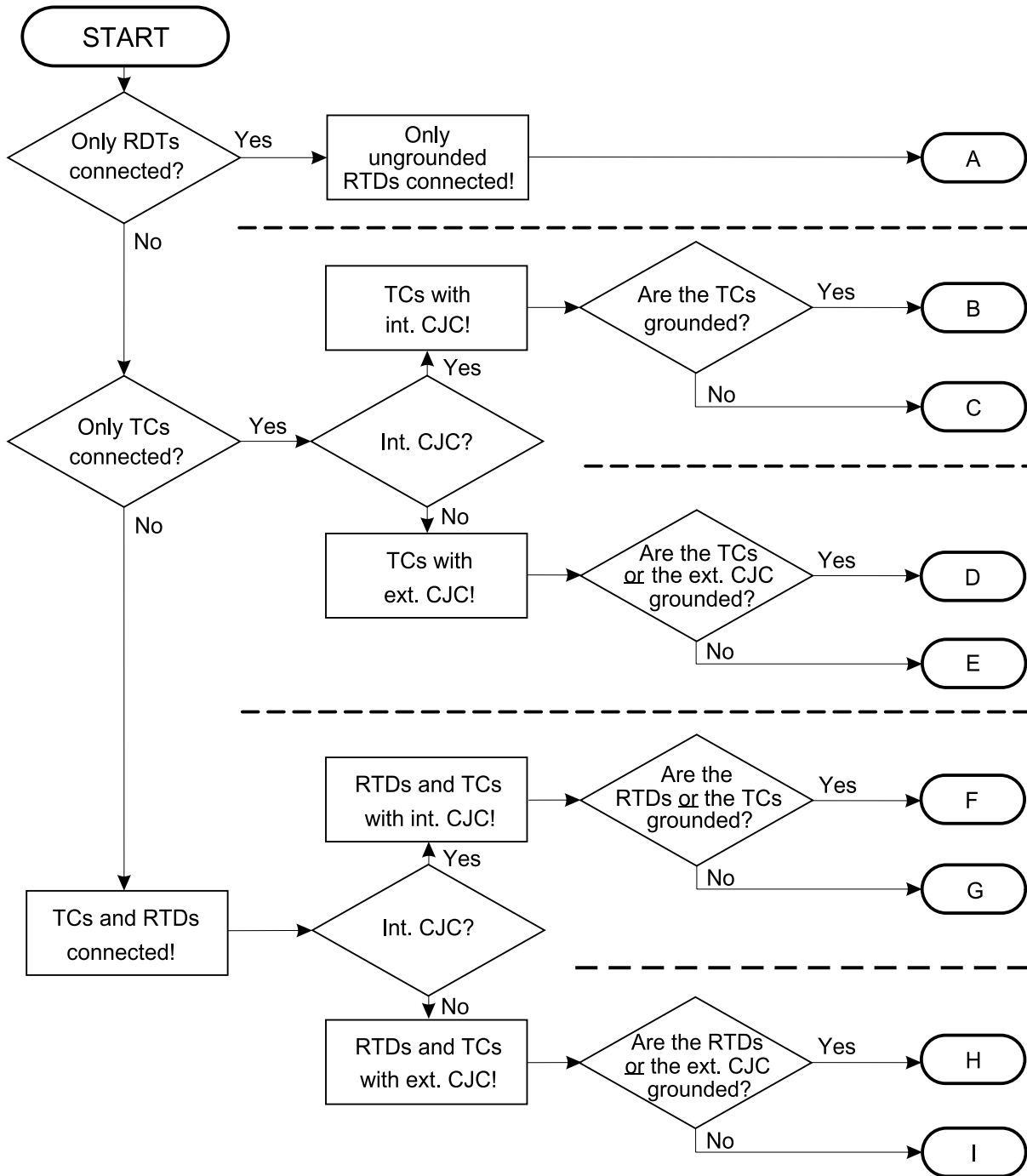

16556E00

Legend

- RTD = Resistance temperature detectors and/or resistance temperature detectors
- TC = Thermocouples and/or mV transmitters
- Ext. / int. CJC = External / internal reference junction
- Unearthed / earthed = Insulated / earthed

## 6.4.2 Possible Types of Circuitry

<p><b>i</b></p>	<p>The following safety data are only applicable to</p> <ul style="list-style-type: none"> <li>• Circuitry with resistance temperature detectors and resistance transmitters (combination of connection A)</li> <li>• Circuitry with thermocouples and mV transmitters (combinations of connection B – E)</li> <li>• Circuitry combinations with resistance temperature detectors, resistance transmitters and thermocouples and mV transmitters (combinations of connection F – I)</li> </ul> <p>Please note:</p> <ul style="list-style-type: none"> <li>• The combinations of connections differ with respect to the specified electrical safety measures (earthing, insulating) and the connected reference junctions (internal, external) of the temperature sensors!</li> <li>• The safety data for the thermocouples, resistance sensors and external reference junctions must be determined separately in each case.</li> <li>• Usually, the temperature sensors can be connected in any configuration. Be sure to use the combinations of connections F – I when connecting additional temperature or resistance sensors.</li> <li>• An external reference junction may only be connected to channels 6 and 7.</li> </ul>
<p><b>i</b></p>	<p>Refer to the certificate for additional maximum safety values!</p>

Combination of connection A: only RTD, unearthed

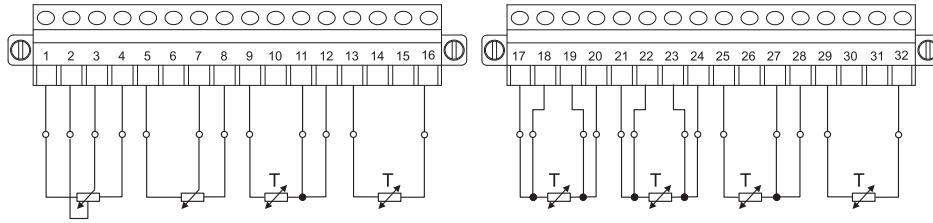

17810E00

Up to 8 resistance temperature detectors or resistance transmitters

Note	No thermocouples / mV transmitters connected, no reference junction connected						
Installation type	insulated						
Max. output voltage $U_{o\ ext}$	6.42 V						
Max. current $I_o$	2-conductor		3-conductor		4-conductor		
Max. power $P_o$	6.5 mA		7.8 mA		9.8 mA		
Max. connectable capacitance $C_o$	10.5 mW		12.5 mW		15.7 mW		
IIC	1.1 $\mu F$	1.2 $\mu F$	1.4 $\mu F$	2.0 $\mu F$	3.2 $\mu F$	7.0 $\mu F$	25 $\mu F$
IIB / IIIC	5.8 $\mu F$	6.3 $\mu F$	7.1 $\mu F$	10 $\mu F$	19 $\mu F$	51 $\mu F$	570 $\mu F$
Max. connectable inductance $L_o$							
IIC	100 mH	50 mH	20 mH	2 mH	0.2 mH	0.02 mH	0.002 mH
IIB / IIIC	100 mH	50 mH	20 mH	2 mH	0.2 mH	0.02 mH	0.002 mH

### Combination of connection B: TC with int. CJC, earthed

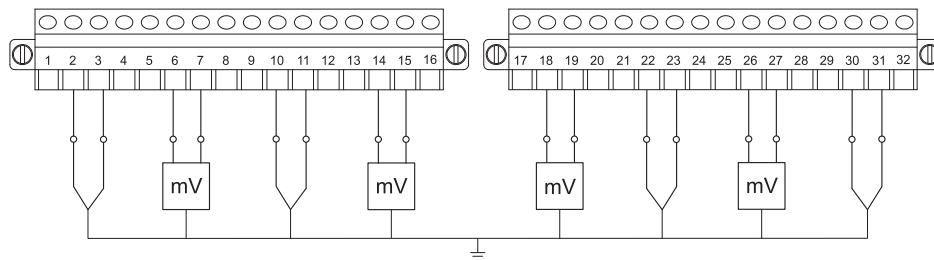

#### Up to 8 earthed thermocouples or mV transmitters with internal reference junction

16553E00

Installation type	earthed						
Reference junction	internal						
Max. output voltage $U_{o\ ext}$	12.92 V						
Max. current $I_o$	25.0 mA						
Max. power $P_o$	81.0 mW						
Max. input voltage $U_i$	6.5 V (for $U_i = 3.5$ V, see table in certificate)						
Max. connectable capacitance $C_o$							
IIC	0.17 $\mu$ F	0.22 $\mu$ F	0.34 $\mu$ F	0.46 $\mu$ F	0.53 $\mu$ F	0.62 $\mu$ F	0.78 $\mu$ F
IIB / IIIC	1.2 $\mu$ F	1.6 $\mu$ F	2.1 $\mu$ F	3.0 $\mu$ F	3.5 $\mu$ F	4.5 $\mu$ F	5.7 $\mu$ F
Max. connectable inductance $L_o$							
IIC	72 mH	50 mH	10 mH	2 mH	1 mH	0.5 mH	0.2 mH
IIB / IIIC	100 mH	20 mH	5 mH	1 mH	0.5 mH	0.2 mH	0.1 mH

### Combination of connection C: TC with int. CJC, unearthed

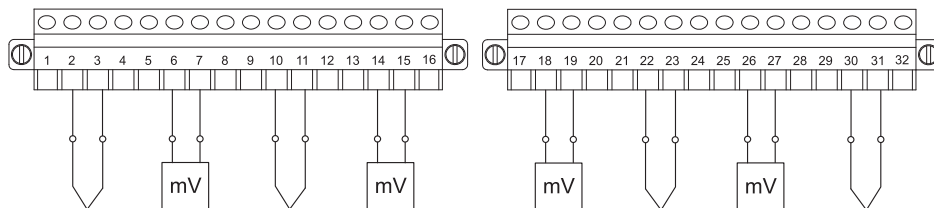

#### Up to 8 insulated thermocouples or mV transmitters with internal reference junction

17811E00

Installation type	insulated						
Reference junction	internal						
Max. output voltage $U_{o\ ext}$	12.92 V						
Max. current $I_o$	6.53 mA						
Max. power $P_o$	21.1 mW						
Max. input voltage $U_i$	6.5 V (for $U_i = 3.5$ V, see table in certificate)						
Max. connectable capacitance $C_o$							
IIC	0.30 $\mu$ F	0.32 $\mu$ F	0.38 $\mu$ F	0.42 $\mu$ F	0.55 $\mu$ F	0.63 $\mu$ F	0.79 $\mu$ F
IIB / IIIC	1.5 $\mu$ F	1.6 $\mu$ F	1.9 $\mu$ F	3.0 $\mu$ F	3.5 $\mu$ F	4.6 $\mu$ F	5.7 $\mu$ F
Max. connectable inductance $L_o$							
IIC	100 mH	50 mH	10 mH	5 mH	1 mH	0.5 mH	0.2 mH
IIB / IIIC	100 mH	50 mH	10 mH	1 mH	0.5 mH	0.2 mH	0.1 mH

Combination of connection D: TC with ext. CJC, earthed

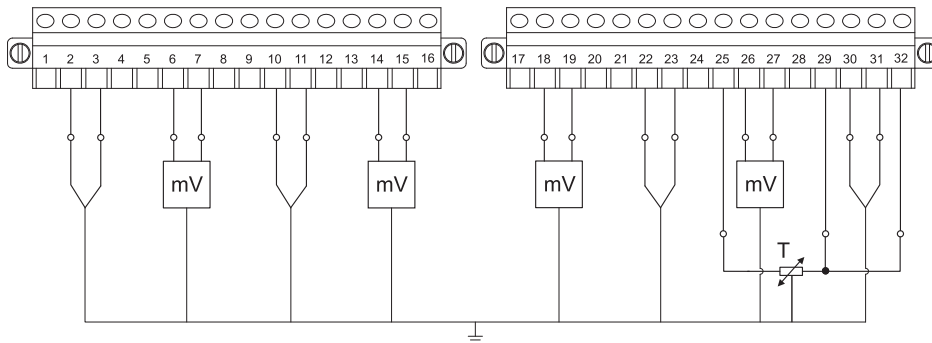

16558E00

Up to 8 earthed thermocouples or mV transmitters with external reference junction

Installation type	earthed							
Reference junction	external							
Max. output voltage $U_{o\ ext}$	12.92 V							
Max. current $I_o$	25.0 mA							
Max. power $P_o$	81.0 mW							
Max. input voltage $U_i$	6.5 V (for $U_i = 3.5$ V, see table in certificate)							
Max. connectable capacitance $C_o$								
IIC	0.17 $\mu$ F	0.22 $\mu$ F	0.34 $\mu$ F	0.46 $\mu$ F	0.53 $\mu$ F	0.62 $\mu$ F	0.78 $\mu$ F	
IIB / IIIC	1.2 $\mu$ F	1.6 $\mu$ F	2.1 $\mu$ F	3.0 $\mu$ F	3.5 $\mu$ F	4.5 $\mu$ F	5.7 $\mu$ F	
Max. connectable inductance $L_o$								
IIC	72 mH	50 mH	10 mH	2 mH	1 mH	0.5 mH	0.2 mH	
IIB / IIIC	100 mH	20 mH	5 mH	1 mH	0.5 mH	0.2 mH	0.1 mH	

Earthed external reference junction

Installation type	earthed							
Reference junction	external (3-conductor)							
Max. output voltage $U_{o\ ext}$	12.92 V							
Max. current $I_o$	68.6 mA							
Max. power $P_o$	222.0 mW							
Max. input voltage $U_i$	6.5 V (for $U_i = 3.5$ V, see table in certificate)							
Max. connectable capacitance $C_o$								
IIC	0.25 $\mu$ F	0.27 $\mu$ F	0.39 $\mu$ F	0.48 $\mu$ F	0.58 $\mu$ F	0.75 $\mu$ F	0.92 $\mu$ F	
IIB / IIIC	1 $\mu$ F	1.1 $\mu$ F	1.5 $\mu$ F	1.9 $\mu$ F	2.8 $\mu$ F	3.4 $\mu$ F	5.6 $\mu$ F	
Max. connectable inductance $L_o$								
IIC	5.6 mH	5 mH	2 mH	1 mH	0.5 mH	0.2 mH	0.1 mH	
IIB / IIIC	25 mH	20 mH	10 mH	5 mH	1 mH	0.5 mH	0.1 mH	



## Combination of connection E: TC with ext. CJC, unearthed

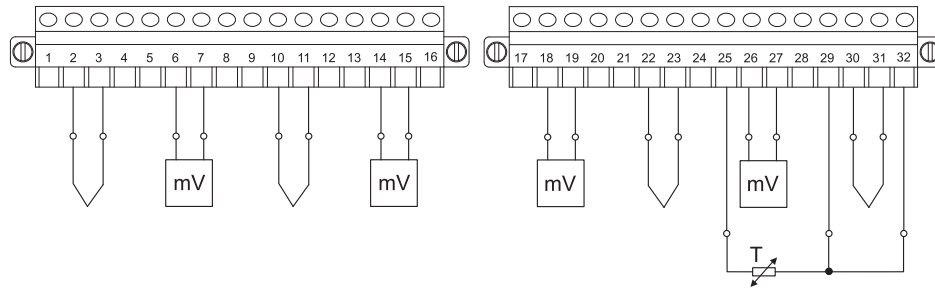

16498E00

### Up to 8 insulated thermocouples or mV transmitters with external reference junction

Installation type	insulated						
Reference junction	external						
Max. output voltage $U_{o\ ext}$	12.92 V						
Max. current $I_o$	6.53 mA						
Max. power $P_o$	21.1 mW						
Max. input voltage $U_i$	6.5 V (for $U_i = 3.5$ V, see table in certificate)						
Max. connectable capacitance $C_o$							
IIC	0.30 $\mu$ F	0.32 $\mu$ F	0.38 $\mu$ F	0.42 $\mu$ F	0.55 $\mu$ F	0.63 $\mu$ F	0.79 $\mu$ F
IIB / IIIC	1.5 $\mu$ F	1.6 $\mu$ F	1.9 $\mu$ F	3.0 $\mu$ F	3.5 $\mu$ F	4.6 $\mu$ F	5.7 $\mu$ F
Max. connectable inductance $L_o$							
IIC	100 mH	50 mH	10 mH	5 mH	1 mH	0.5 mH	0.2 mH
IIB / IIIC	100 mH	50 mH	10 mH	1 mH	0.5 mH	0.2 mH	0.1 mH

### Insulated external reference junction

Installation type	insulated						
Reference junction	external (3-conductor)						
Max. output voltage $U_{o\ ext}$	12.92 V						
Max. current $I_o$	17.4 mA						
Max. power $P_o$	56.2 mW						
Max. input voltage $U_i$	6.5 V (for $U_i = 3.5$ V, see table in certificate)						
Max. connectable capacitance $C_o$							
IIC	0.17 $\mu$ F	0.21 $\mu$ F	0.29 $\mu$ F	0.39 $\mu$ F	0.53 $\mu$ F	0.62 $\mu$ F	0.78 $\mu$ F
IIB / IIIC	1.2 $\mu$ F	1.6 $\mu$ F	2.1 $\mu$ F	2.9 $\mu$ F	3.5 $\mu$ F	4.5 $\mu$ F	5.7 $\mu$ F
Max. connectable inductance $L_o$							
IIC	66 mH	50 mH	20 mH	5 mH	1 mH	0.5 mH	0.2 mH
IIB / IIIC	100 mH	20 mH	5 mH	1 mH	0.5 mH	0.2 mH	0.1 mH

Combination of connection F: RTD and TC Mixed with int. CJC, earthed

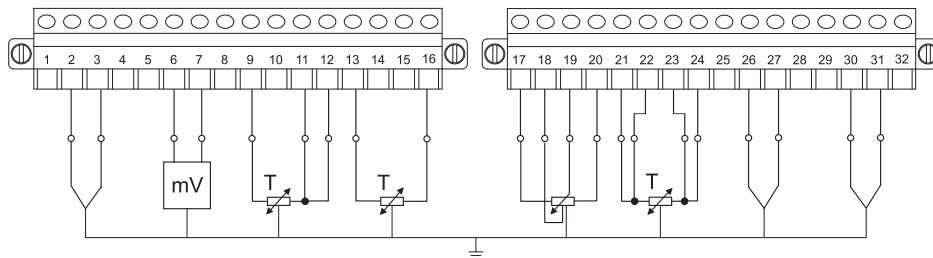

16560E00

Up to 8 earthed thermocouples or mV transmitters with internal reference junction

Installation type	earthed							
Reference junction	internal							
Max. output voltage $U_{o\ ext}$	12.92 V							
Max. current $I_o$	25.0 mA							
Max. power $P_o$	81.0 mW							
Max. input voltage $U_i$	6.5 V (for $U_i = 3.5$ V, see table in certificate)							
Max. connectable capacitance $C_o$								
IIC	0.17 $\mu$ F	0.22 $\mu$ F	0.34 $\mu$ F	0.46 $\mu$ F	0.53 $\mu$ F	0.62 $\mu$ F	0.78 $\mu$ F	
IIB / IIIC	1.2 $\mu$ F	1.6 $\mu$ F	2.1 $\mu$ F	3.0 $\mu$ F	3.5 $\mu$ F	4.5 $\mu$ F	5.7 $\mu$ F	
Max. connectable inductance $L_o$								
IIC	72 mH	50 mH	10 mH	2 mH	1 mH	0.5 mH	0.2 mH	
IIB / IIIC	100 mH	20 mH	5 mH	1 mH	0.5 mH	0.2 mH	0.1 mH	

Up to 8 earthed resistance temperature detectors or resistance transmitters

Installation type	earthed							
Max. output voltage $U_{o\ ext}$	12.92 V							
	2-conductor		3-conductor		4-conductor			
Max. current $I_o$	47.9 mA		58.5 mA		68.8 mA			
Max. power $P_o$	155.0 mW		189.0 mW		220.0 mW			
Max. input voltage $U_i$	6.5 V (for $U_i = 3.5$ V, see table in certificate)							
Max. connectable capacitance $C_o$								
IIC	0.23 $\mu$ F	0.31 $\mu$ F	0.41 $\mu$ F	0.50 $\mu$ F	0.60 $\mu$ F	0.76 $\mu$ F	0.93 $\mu$ F	
IIB / IIIC	0.94 $\mu$ F	1.3 $\mu$ F	1.6 $\mu$ F	1.9 $\mu$ F	2.9 $\mu$ F	3.4 $\mu$ F	5.6 $\mu$ F	
Max. connectable inductance $L_o$								
IIC	9 mH	5 mH	2 mH	1 mH	0.5 mH	0.2 mH	0.1 mH	
IIB / IIIC	40 mH	20 mH	10 mH	5 mH	1 mH	0.5 mH	0.1 mH	

### Combination of connection G: RTD and TC Mixed with int. CJC, unearthed

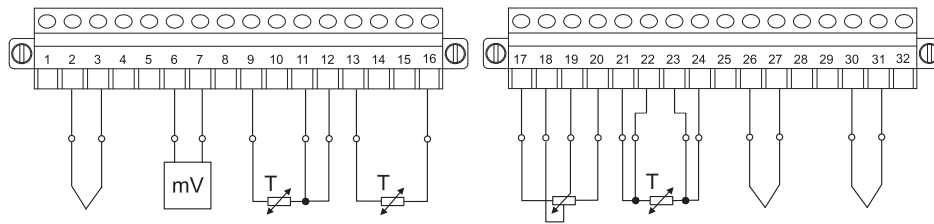

16559E00

#### Up to 8 insulated thermocouples or mV transmitters with internal reference junction

Installation type	insulated						
Reference junction	internal						
Max. output voltage $U_{o\ ext}$	12.92 V						
Max. current $I_o$	6.53 mA						
Max. power $P_o$	21.1 mW						
Max. input voltage $U_i$	6.5 V (for $U_i = 3.5$ V, see table in certificate)						
Max. connectable capacitance $C_o$							
IIC	0.30 $\mu$ F	0.32 $\mu$ F	0.38 $\mu$ F	0.42 $\mu$ F	0.55 $\mu$ F	0.63 $\mu$ F	0.79 $\mu$ F
IIB / IIIC	1.5 $\mu$ F	1.6 $\mu$ F	1.9 $\mu$ F	3.0 $\mu$ F	3.5 $\mu$ F	4.6 $\mu$ F	5.7 $\mu$ F
Max. connectable inductance $L_o$							
IIC	100 mH	50 mH	10 mH	5 mH	1 mH	0.5 mH	0.2 mH
IIB / IIIC	100 mH	50 mH	10 mH	1 mH	0.5 mH	0.2 mH	0.1 mH

#### Up to 8 insulated resistance temperature detectors or resistance transmitters

Installation type	insulated						
Max. output voltage $U_{o\ ext}$	12.92 V						
	2-conductor		3-conductor		4-conductor		
Max. current $I_o$	13.1 mA		15.7 mA		19.6 mA		
Max. power $P_o$	42.2 mW		50.6 mW		63.3 mW		
Max. input voltage $U_i$	6.5 V (for $U_i = 3.5$ V, see table in certificate)						
Max. connectable capacitance $C_o$							
IIC	0.19 $\mu$ F	0.25 $\mu$ F	0.31 $\mu$ F	0.40 $\mu$ F	0.54 $\mu$ F	0.63 $\mu$ F	0.78 $\mu$ F
IIB / IIIC	1.3 $\mu$ F	1.7 $\mu$ F	1.9 $\mu$ F	2.5 $\mu$ F	3.0 $\mu$ F	3.5 $\mu$ F	5.7 $\mu$ F
Max. connectable inductance $L_o$							
IIC	100 mH	50 mH	20 mH	5 mH	1 mH	0.5 mH	0.2 mH
IIB / IIIC	100 mH	20 mH	10 mH	2 mH	1 mH	0.5 mH	0.1 mH

Combination of connection H: RTD and TC Mixed with ext. CJC, earthed

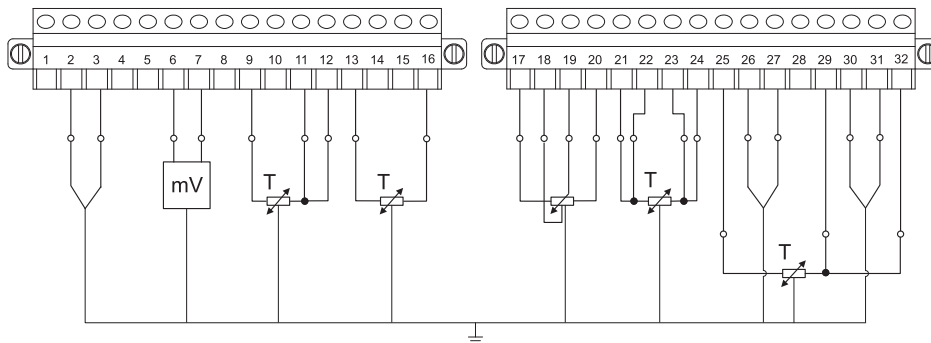

16561E00

Up to 8 earthed thermocouples or mV transmitters with external reference junction

Installation type	earthed						
Reference junction	external						
Max. output voltage $U_{o\ ext}$	12.92 V						
Max. current $I_o$	25.0 mA						
Max. power $P_o$	81.0 mW						
Max. input voltage $U_i$	6.5 V (for $U_i = 3.5$ V, see table in certificate)						
Max. connectable capacitance $C_o$							
IIC	0.17 $\mu$ F	0.22 $\mu$ F	0.34 $\mu$ F	0.46 $\mu$ F	0.53 $\mu$ F	0.62 $\mu$ F	0.78 $\mu$ F
IIB / IIIC	1.2 $\mu$ F	1.6 $\mu$ F	2.1 $\mu$ F	3.0 $\mu$ F	3.5 $\mu$ F	4.5 $\mu$ F	5.7 $\mu$ F
Max. connectable inductance $L_o$							
IIC	72 mH	50 mH	10 mH	2 mH	1 mH	0.5 mH	0.2 mH
IIB / IIIC	100 mH	20 mH	5 mH	1 mH	0.5 mH	0.2 mH	0.1 mH

Up to 8 earthed resistance temperature detectors or resistance transmitters

Installation type	earthed						
Max. output voltage $U_{o\ ext}$	12.92 V						
	2-conductor		3-conductor		4-conductor		
Max. current $I_o$	47.9 mA		58.5 mA		68.8 mA		
Max. power $P_o$	155.0 mW		189.0 mW		220.0 mW		
Max. input voltage $U_i$	6.5 V (for $U_i = 3.5$ V, see table in certificate)						
Max. connectable capacitance $C_o$							
IIC	0.23 $\mu$ F	0.31 $\mu$ F	0.41 $\mu$ F	0.50 $\mu$ F	0.60 $\mu$ F	0.76 $\mu$ F	0.93 $\mu$ F
IIB / IIIC	0.94 $\mu$ F	1.3 $\mu$ F	1.6 $\mu$ F	1.9 $\mu$ F	2.9 $\mu$ F	3.4 $\mu$ F	5.6 $\mu$ F
Max. connectable inductance $L_o$							
IIC	9 mH	5 mH	2 mH	1 mH	0.5 mH	0.2 mH	0.1 mH
IIB / IIIC	40 mH	20 mH	10 mH	5 mH	1 mH	0.5 mH	0.1 mH

### Earthed external reference junction

Installation type	earthed						
Reference junction	external (3 conductors)						
Max. output voltage $U_{o\ ext}$	12.92 V						
Max. current $I_o$	68.8 mA						
Max. power $P_o$	222.0 mW						
Max. input voltage $U_i$	6.5 V (for $U_i = 3.5$ V, see table in certificate)						
Max. connectable capacitance $C_o$							
IIC	0.25 $\mu$ F	0.27 $\mu$ F	0.39 $\mu$ F	0.48 $\mu$ F	0.58 $\mu$ F	0.75 $\mu$ F	0.92 $\mu$ F
IIB / IIIC	1 $\mu$ F	1.1 $\mu$ F	1.5 $\mu$ F	1.9 $\mu$ F	2.8 $\mu$ F	3.4 $\mu$ F	5.6 $\mu$ F
Max. connectable inductance $L_o$							
IIC	5.6 mH	5 mH	2 mH	1 mH	0.5 mH	0.2 mH	0.1 mH
IIB / IIIC	25 mH	20 mH	10 mH	5 mH	1 mH	0.5 mH	0.1 mH

### Combination of connection I: RTD and TC Mixed with ext. CJC, unearthed

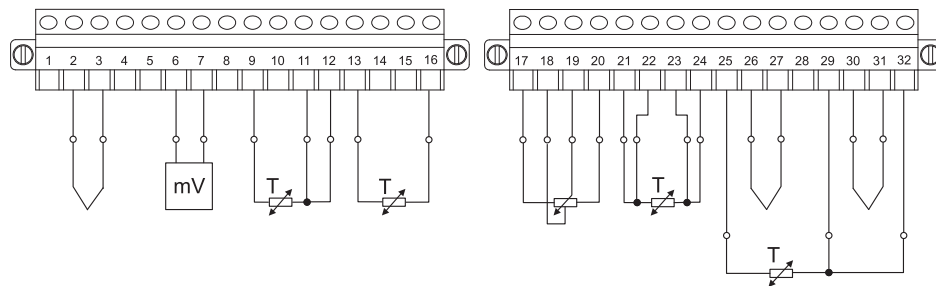

16497E00

### Up to 8 insulated thermocouples or mV transmitters with external reference junction

Installation type	insulated						
Reference junction	external						
Max. output voltage $U_{o\ ext}$	12.92 V						
Max. current $I_o$	6.53 mA						
Max. power $P_o$	21.1 mW						
Max. input voltage $U_i$	6.5 V (for $U_i = 3.5$ V, see table in certificate)						
Max. connectable capacitance $C_o$							
IIC	0.30 $\mu$ F	0.32 $\mu$ F	0.38 $\mu$ F	0.42 $\mu$ F	0.55 $\mu$ F	0.63 $\mu$ F	0.79 $\mu$ F
IIB / IIIC	1.5 $\mu$ F	1.6 $\mu$ F	1.9 $\mu$ F	3.0 $\mu$ F	3.5 $\mu$ F	4.6 $\mu$ F	5.7 $\mu$ F
Max. connectable inductance $L_o$							
IIC	100 mH	50 mH	10 mH	5 mH	1 mH	0.5 mH	0.2 mH
IIB / IIIC	100 mH	50 mH	10 mH	1 mH	0.5 mH	0.2 mH	0.1 mH

Up to 8 insulated resistance temperature detectors or resistance transmitters

Installation type	insulated							
Max. output voltage $U_{o\ ext}$	12.92 V							
	2-conductor		3-conductor		4-conductor			
Max. current $I_o$	13.1 mA		15.7 mA		19.6 mA			
Max. power $P_o$	42.2 mW		50.6 mW		63.3 mW			
Max. input voltage $U_i$	6.5 V (for $U_i = 3.5$ V, see table in certificate)							
Max. connectable capacitance $C_o$								
IIC	0.19 $\mu$ F	0.25 $\mu$ F	0.31 $\mu$ F	0.40 $\mu$ F	0.54 $\mu$ F	0.63 $\mu$ F	0.78 $\mu$ F	
IIB / IIIC	1.3 $\mu$ F	1.7 $\mu$ F	1.9 $\mu$ F	2.5 $\mu$ F	3.0 $\mu$ F	3.5 $\mu$ F	5.7 $\mu$ F	
Max. connectable inductance $L_o$								
IIC	100 mH	50 mH	20 mH	5 mH	1 mH	0.5 mH	0.2 mH	
IIB / IIIC	100 mH	20 mH	10 mH	2 mH	1 mH	0.5 mH	0.1 mH	

Insulated external reference junction

Installation type	insulated							
Reference junction	external (3 conductors)							
Max. output voltage $U_{o\ ext}$	12.92 V							
Max. current $I_o$	17.4 mA							
Max. power $P_o$	56.2 mW							
Max. input voltage $U_i$	6.5 V (for $U_i = 3.5$ V, see table in certificate)							
Max. connectable capacitance $C_o$								
IIC	0.17 $\mu$ F	0.21 $\mu$ F	0.29 $\mu$ F	0.39 $\mu$ F	0.53 $\mu$ F	0.62 $\mu$ F	0.78 $\mu$ F	
IIB / IIIC	1.2 $\mu$ F	1.6 $\mu$ F	2.1 $\mu$ F	2.9 $\mu$ F	3.5 $\mu$ F	4.5 $\mu$ F	5.7 $\mu$ F	
Max. connectable inductance $L_o$								
IIC	66 mH	50 mH	20 mH	5 mH	1 mH	0.5 mH	0.2 mH	
IIB / IIIC	100 mH	20 mH	5 mH	1 mH	0.5 mH	0.2 mH	0.1 mH	

7 Transport and Storage

- Transport and store the device only in the original packaging.
- Store the device in a dry place (no condensation) and vibration-free.
- Do not drop the device.

## 8 Mounting and Installation

The device is approved for use in gas explosion hazardous areas of Zone 2 and dust explosion hazardous area of Zone 22 and in safe areas.



If the installation has strong electromagnetic sources of interference or the electrical lines are more than 30 m long, use of shielded field cables is recommended to achieve the specified data. To this end, the shield must be connected to the equipotential bonding of the hazardous area and placed on the shield busses in the enclosure as close to the entry point as possible. The shield busses must also be connected to the mounting plate close to the entry point of the field wiring using the shortest possible route. See the "Grounding and shielding" instructions.

### 8.1 Dimensions / Fastening Dimensions

**Dimensional drawings** (All dimensions in mm [inches]) – Subject to alterations

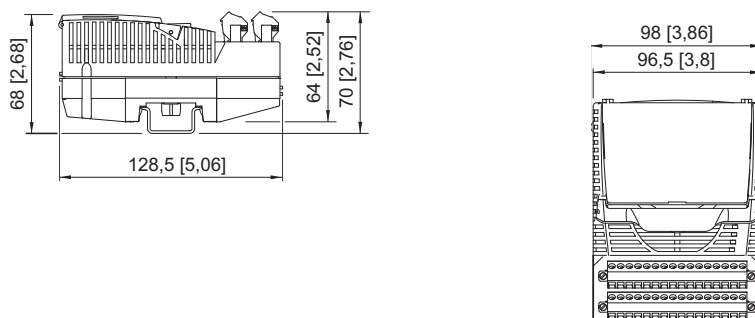

15254E00

### 8.2 Mounting / Dismounting, Operating Position

#### 8.2.1 Mounting / Dismounting on BusRail

#### **NOTICE**

Malfunction or device damage caused by improper mounting.

Non-compliance may lead to material damage!

- Only install and operate the device in a vertical or horizontal position!  
(Horizontal orientation: Reading direction from below)

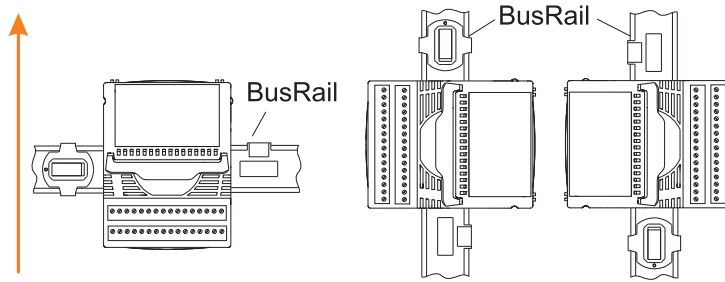

2073E00

## Mounting on BusRail

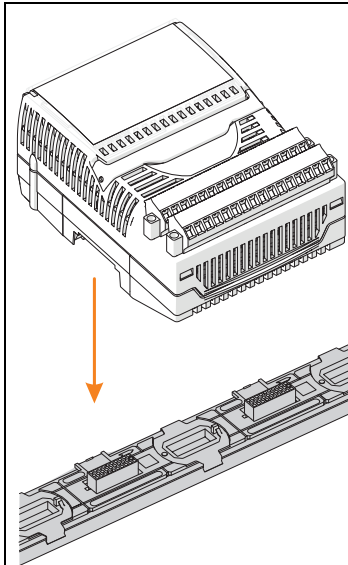

20761E00

- Position the module vertically at the intended slot of the BusRail and press lightly to snap it into place.
- Press the module down onto the BusRail to ensure that it is properly secured! There should not be any gap between the module and BusRail! The module must not be able to disconnect without the handle being actuated.
- Plug the pluggable terminals X1 and X2 into the module and secure them against loosening using safety screws (tightening torque 0.5 to 0.6 Nm).
- To ensure a distance of at least 50 mm between the intrinsically safe and non-intrinsically safe electrical circuits, if necessary, mount a partition (220101) on the adjacent Ex i module or leave a space between the Ex i and non-Ex i modules.

**Note:**

The partition can only be mounted on Ex i modules. If the Ex i module has 2 terminal blocks, the partition must be machined further (predetermined breaking point).



## 8.2.2 Requirements for Dismounting / Module Replacement

Observe the following before dismounting and replacing the module:

- During operation in a non-hazardous area, it is functionally possible to insert/remove terminals X1 and X2 at any time. In addition, the module may also be mounted on the BusRail or removed (hot swap).
- If there is no field cable connected or if this is de-energised, the module can be mounted on or removed from the BusRail in the hazardous area.
- During operation in hazardous areas, pluggable field cable connections X1, X2 may only be plugged in or removed in the hazardous area if they are de-energised. Therefore, all the electrical circuits connected to terminals X1 and X2 must be disconnected from the supply in advance.

### Dismounting

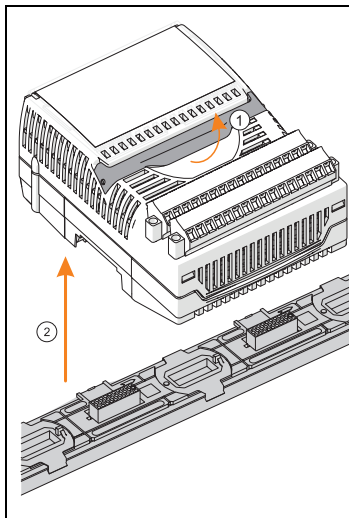

- Loosen the screws of pluggable terminals X1 and X2.
- Disconnect pluggable terminals X1 and X2 from the module to be replaced.
- Pull the blue notch lever of the module upwards (1) to unlock the module.
- Remove the module vertically from the BusRail (2).

20762E00

### Module replacement (after dismounting)

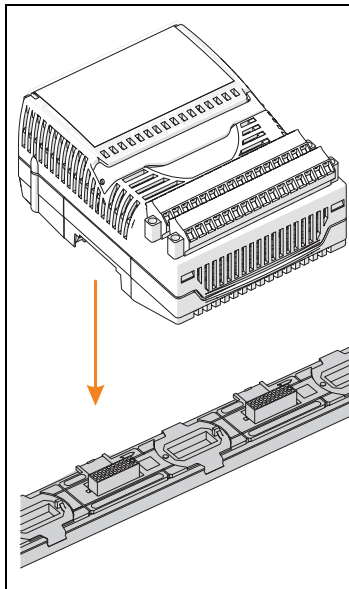

- Position the new module vertically at the intended slot of the BusRail and press lightly to snap it into place.
- Press the module down onto the BusRail to ensure that it is properly secured. When doing this, check that there is no gap between the module and BusRail. The module must not be able to disconnect without the notch lever being actuated.
- Plug the pluggable terminals X1 and X2 into the module and secure them against loosening using screws (tightening torque 0.5 to 0.6 Nm).

20761E00

### Replacing modules

<b>i</b>	<p>When replacing the module with a module with identical design, the set parameters are maintained. No further user adjustments are necessary. When replacing the module with a module with a different function, the module reports a configuration error (red "ERR" LED flashes). The module must be either re-configured or replaced with a module of correct type.</p>
----------	---

Observe the following when replacing an IS1 module 9480/12 or 9481/12 with an IS1+ module 9482/32 with the same functions:

- Ensure that the terminal assignment is adapted to that of the 9482/32.
- In order to use the new IS1+ functions, update the firmware of the 9440 CPM or 9441 CPU if necessary.
- If necessary, use a new GSD in PROFIBUS-DP operation.
- Please contact your responsible distributor for further information.

### 8.3 Installation

<b>i</b>	<p>Operation under difficult conditions, such as, in particular, on ships, requires additional measures to be taken for correct installation, depending on the place of use. Further information and instructions on this can be obtained from your regional sales contact on request.</p>
----------	--

The cover flap features an insert disc which can be used to enter the assignment of the field devices to the channels. IS Wizard can be used, for example, to label the insert disc.

- Connect the field devices to the pluggable terminals X1 and X2 according to terminal assignment (see the "Project engineering" chapter or insert disc on the inside of the protective cover).
- Place the field wiring shields (if available) as close to the entry point of the field enclosure on the earthing rail as possible.
- Where necessary, snap the partition into place on the adjacent Ex i module.
- Plug the pluggable terminals X1 and X2 into the module and secure them against loosening using screws (tightening torque 0.5 to 0.6 Nm).

<b>i</b>	<p>The module and the pluggable terminals X1 and X2 can be safely connected or disconnected during operation in the hazardous area (hot swap).</p>
----------	--

## 9 Commissioning

Before commissioning, ensure the following:

- Installation of the device according to regulations.
- Correct connection of the cables.
- No damage at the device and connection cables.
- Tight seat of the screws at the terminals.  
Correct tightening torque: 0.5 to 0.6 Nm.

### 9.1 Compensation for 2-Wire Resistance Temperature Detector

- Configure TIM 9482, set channel to "2 conductors (R in  $\Omega$ )" and start remote I/O (green "RUN" LED at I/O module = ON).
- Short-circuit the sensor to the connection cable of the channel to be adjusted near the sensor for approx. 10 seconds (min. 6, max. 14 sec.).
- During the compensation, make sure that there is a low-resistance short-circuit at the cable end (line resistance lower than 15  $\Omega$  and diagnostics indicate a short circuit).
- In case of a short-circuit at both ends, check the correct function of the measuring point. If a signal error is indicated on the I/O module (red "ERR" LED on the I/O module = ON) and "Error 2-wire compensation failed" is signalled in the automation system, the 2-wire compensation has not been completed correctly.
- Perform a new compensation.

Compensation for Pt100 GOST, M50 GOST, M100 GOST, Cu53 GOST, Pt46 GOST, Pt50 GOST and resistance measurement

- First, set it to Pt1000, then carry out a compensation and set it back to the desired sensor. A value determined once for the line resistance of 2-wire systems is stored for each channel.

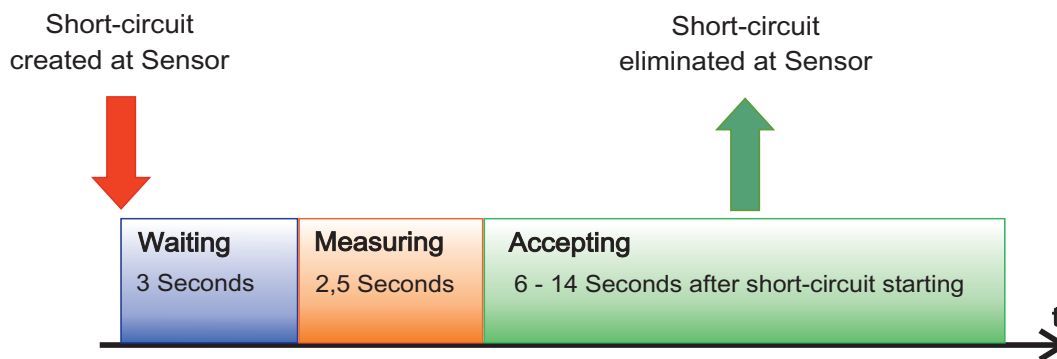

16557E01

## 9.2 Potentiometer in quick 4-Wire Operation (Joystick)

In this operating mode, very short signal delays are achieved, which allows for special applications, such as joystick applications.

- Configuration of TIM 9482
- Set the operating mode of the module to "4 channel R fast".
- Set the channel to the "4-conductor" type of connection.
- Select the required resistance for the channel under the input type.

If the 4-conductor operation with potentiometer (joystick) is selected, only the first 4 channels can be used (0-3).

Schematic	
	16510E00
	4-conductor joystick
Channel	X1 terminals
0	1 (I+), 2 (V+), 3 (V-), 4 (I-)
1	5 (I+), 6 (V+), 7 (V-), 8 (I-)
2	9 (I+), 10 (V+), 11 (V-), 12 (I-)
3	13 (I+), 14 (V+), 15 (V-), 16 (I-)

## 10 Operation

### 10.1 Indication

The corresponding LEDs on the device indicate the operating state of the device (see also the chapter "Function and device design").

LED	Colour	Meaning
"RUN" LED	green	Operation indication: Device runs error-free
"ERR" LED	red	Module error indication
"M/S" LED	blue	Requires maintenance or is outside the specifications

## 10.2 Troubleshooting

For troubleshooting, refer to the following troubleshooting guide:

Error	Cause of error	Troubleshooting
"RUN" LED is flashing	The module is in proper condition but is not ready for cyclic data exchange yet (a parameter set is not yet available). The outputs are inactive	<ul style="list-style-type: none"> <li>• Activate the cyclic data transfer with the master</li> <li>• Check master, bus connection and CPM and CPU &amp; PM</li> </ul>
"RUN" LED is off	<ul style="list-style-type: none"> <li>• No supply voltage present at the I/O module</li> <li>• I/O module defective</li> </ul>	<ul style="list-style-type: none"> <li>• Check the system supply</li> <li>• Check the CPM or CPU and PM</li> <li>• Check the BusRail</li> <li>• Snap the I/O module correctly into place on the BusRail</li> <li>• Replace the I/O module</li> </ul>
"ERR" LED is flashing	<ul style="list-style-type: none"> <li>• Error in the field circuit</li> <li>• Line breakage or short circuit</li> <li>• Measuring range has been overshoot or undershot</li> </ul>	<ul style="list-style-type: none"> <li>• Check the "red" signal LEDs</li> <li>• Eliminate the cause in the indicated field circuit, check electrical lines and field devices</li> </ul>
	Configuration is not correct or a wrong module is connected	Change configuration in the automation system or connect the correct module
	Cyclic data transfer with the automation system has been interrupted	<ul style="list-style-type: none"> <li>• Check the cyclic data transfer of CPM or CPU (LCD or "RUN" LED)</li> <li>• Check bus connection</li> <li>• Activate the cyclic data transfer with the automation system</li> </ul>
"ERR" LED lights up	Module is defective	Replace the module
"M/S" LED is flashing	Ambient temperature is outside the specification	Reduce ambient temperature, e.g. by shading or cooling <b>Note: Module will be permanently damaged if not rectified</b>
"M/S" LED is lit	Slot error or module is damaged due to excessive temperature or end of service life reached	Replace the module as soon as possible (within the next 12 months), otherwise there is a risk of module failure

If the error cannot be eliminated using the specified procedures:

- Contact R. STAHL Schaltgeräte GmbH.

For rapid processing, have the following information ready:

- Type and serial number of the device
- DCS/PLC
- Protocol
- Revision no./firmware version
- Purchase information
- Error description
- Intended use (in particular input and output wiring)

## 11 Maintenance, Overhaul, Repair

### 11.1 Maintenance



- Consult the relevant national regulations to determine the type and extent of inspections.
- Adapt inspection intervals to the operating conditions.

During maintenance of the device, check at least:

- whether the clamping screws holding the electric lines are securely seated,
- whether the device enclosure and / or protective enclosure have cracks or other visible signs of damage,
- whether the permissible ambient temperatures are observed,
- whether the device is used according to its designated use.

### 11.2 Overhaul

The device does not require regular maintenance.

	If the blue "M/S" LED lights up continuously, it is recommended to replace the module in the near future. Otherwise the likelihood of failure will increase after 12 months (see chapter "Indications" and "Troubleshooting").
	Observe the relevant national regulations in the country of use.

### 11.3 Repair

	<b>DANGER</b>
	<p>Explosion hazard due to improper repair!                      Non-compliance results in severe or fatal injuries.</p> <ul style="list-style-type: none"> <li>• Repair work on the devices must be performed only by R. STAHL Schaltgeräte GmbH.</li> </ul>

## 11.4 Returning the Device

- Only return or package the devices after consulting R. STAHL!  
Contact the responsible representative from R. STAHL.

R. STAHL's customer service is available to handle returns if repair or service is required.

- Contact customer service personally.

or

- Go to the [r-stahl.com](http://r-stahl.com) website.
- Under "Support" > "RMA" > select "RMA-REQUEST".
- Fill out the form and send it.  
You will automatically receive an RMA form via email. Please print this file off.
- Send the device along with the RMA form in the packaging to  
R. STAHL Schaltgeräte GmbH (refer to chapter 1.1 for the address).

## 12 Cleaning

- To avoid electrostatic charging, the devices located in potentially explosive areas may only be cleaned using a damp cloth.
- When cleaning with a damp cloth, use water or mild, non-abrasive, non-scratching cleaning agents.
- Do not use aggressive detergents or solvents.

## 13 Disposal

- Observe national and local regulations and statutory regulation regarding disposal.
- Separate materials when sending it for recycling.
- Ensure environmentally friendly disposal of all components according to the statutory regulations.

## 14 Accessories and Spare Parts

### *NOTICE*

Malfunction or damage to the device due to the use of non-original components.

Non-compliance can result in material damage.

- Use only original accessories and spare parts from  
R. STAHL Schaltgeräte GmbH.



For accessories and spare parts, see data sheet on our homepage [r-stahl.com](http://r-stahl.com).

**EU-Konformitätserklärung**  
*EU Declaration of Conformity*  
*Déclaration de Conformité UE*



**R. STAHL Schaltgeräte GmbH • Am Bahnhof 30 • 74638 Waldenburg, Germany**  
*erklärt in alleiniger Verantwortung / declares in its sole responsibility / déclare sous sa seule responsabilité*

**dass das Produkt:** **Temperatur Input Modul**  
*that the product:* *Temperature Input Module*  
*que le produit:* *Module d'Entrée de Température*

**Typ(en) / type(s) / type(s):** **9482/3b-08-1f ( b = 2, 3 ; f = 0, 1 )**

**mit den Anforderungen der folgenden Richtlinien und Normen übereinstimmt.**  
*is in conformity with the requirements of the following directives and standards.*  
*est conforme aux exigences des directives et des normes suivantes.*

Richtlinie(n) / Directive(s) / Directive(s)		Norm(en) / Standard(s) / Norme(s)
2014/34/EU 2014/34/EU 2014/34/UE	<b>ATEX-Richtlinie</b> <i>ATEX Directive</i> <i>Directive ATEX</i>	EN IEC 60079-0:2018 EN 60079-7:2015 + A1:2018 EN 60079-11:2012
<b>Kennzeichnung für / marking for / marquage pour:</b> <b>9482/32-08-1*</b>		<b>II 2 (1) G Ex ia [ia Ga] IIC T4 Gb</b> <b>II (1) D [Ex ia Da] IIIC</b> <span style="float: right;"><b>CE</b>0158</span>
<b>Kennzeichnung für / marking for / marquage pour:</b> <b>9482/33-08-1*</b>		<b>II 3 (1) G Ex ec ia [ia Ga] IIC T4 Gc</b> <b>II (1) D [Ex ia Da] IIIC</b> <span style="float: right;"><b>CE</b>0158</span>
<b>EU-Baumusterprüfbescheinigung:</b> <i>EU Type Examination Certificate:</i> <i>Attestation d'examen UE de type:</i>		<b>DEKRA 13 ATEX 0140 X</b> (DEKRA Certification B.V., Meander 1051, 6825 MJ Arnhem, Netherlands, NB0344)
<b>Produktnormen nach Niederspannungsrichtlinie:</b> <i>Product standards according to Low Voltage Directive:</i> <i>Normes des produit pour la Directive Basse Tension:</i>		<b>In Anlehnung / According to / Selon:</b> EN 50178:1997 EN 61010-1:2010
2014/30/EU 2014/30/EU 2014/30/UE	<b>EMV-Richtlinie</b> <i>EMC Directive</i> <i>Directive CEM</i>	EN 61326-1:2013
2011/65/EU 2011/65/EU 2011/65/UE	<b>RoHS-Richtlinie</b> <i>RoHS Directive</i> <i>Directive RoHS</i>	EN 50581:2012

Waldenburg, 2020-06-18

**Ort und Datum**  
*Place and date*  
*Lieu et date*

i.V.

**Carsten Brenner**  
**Leiter Geschäftsbereich Automation**  
*Vice President Business Unit Automation*  
*Vice-président Business Unit Automation*

i.V.

**Jürgen Freimüller**  
**Leiter Qualitätsmanagement**  
*Director Quality Management*  
*Directeur Assurance de Qualité*



Nonhazardous  
Class I, II, III, Division 2, Group A-G  
or Class I, Zone 2, Group IIC/IIB  
Hazardous (Classified) Locations



Example connection:

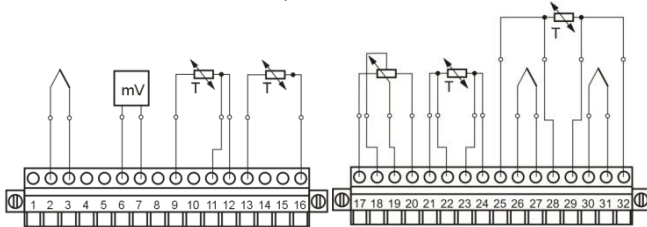

**Wiring legend**

Connection allocation example for RTD or potentiometer  
– Temperature Input Module Type 9482

Channel	X1 / X2 2 Wire Input	X1 / X2 3 Wire Input	X1 / X2 4 Wire Input
	Terminals	Terminals	Terminals
0	1(I+), 4(I-)	1(I+), 3(V-), 4(I-)	1(I+), 2(V+), 3(V-), 4(I-)
1	5(I+), 8(I-)	5(I+), 7(V-), 8(I-)	5(I+), 6(V+), 7(V-), 8(I-)
2	9(I+), 12(I-)	9(I+), 11(V-), 12(I-)	9(I+), 10(V+), 11(V-), 12(I-)
3	13(I+), 16(I-)	13(I+), 15(V-), 16(I-)	13(I+), 14(V+), 15(V-), 16(I-)
4	17(I+), 20(I-)	17(I+), 19(V-), 20(I-)	17(I+), 18(V+), 19(V-), 20(I-)
5	21(I+), 24(I-)	21(I+), 23(V-), 24(I-)	21(I+), 22(V+), 23(V-), 24(I-)
6	25(I+), 28(I-)	25(I+), 27(V-), 28(I-)	25(I+), 26(V+), 27(V-), 28(I-)
7	29(I+), 32(I-)	29(I+), 31(V-), 32(I-)	29(I+), 30(V+), 31(V-), 32(I-)

The signals are connected together via resistors by an internal common ground.  
Any combination of 2-, 3- and 4-wire connection is possible.

Connection allocation example thermocouples or mV-sources and external CJC

– Temperature Input Module Type 9482

Channel	Thermocouple	External CJC 2 Wire	External CJC 3 Wire	External CJC 4 Wire
	Terminals	Terminals	Terminals	Terminals
0	2(V+), 3(V-)	-	-	-
1	6(V+), 7(V-)	-	-	-
2	10(V+), 11(V-)	-	-	-
3	14(V+), 15(V-)	-	-	-
4	18(V+), 19(V-)	-	-	-
5	22(V+), 23(V-)	-	-	-
6	26(V+), 27(V-)	25(I+) 32(I-)	25(I+) 29(I+) 32(I-)	25(I+) 28(I-) 29(I+) 32(I-)
7	30(V+), 31(V-)			

The signals are connected together via resistors by an internal common ground.

The Type 9482 Temperature Input Module is designed to receive up to 8 input signals from 2-/3- or 4-wire RTDs and potentiometers or up to eight thermocouples and mV sensors. Via the channels 6 and 7 a connection of an external cold junction compensation (CJC) via an RTD is also possible. The module transmit those signals to the IS1 CPU & Power Module.

The module is nonincendive for installation in a Class I, II, III, Division 2, Group A-G or Class I, Zone 2, Group IIC/IIB hazardous location according to NEC Article 504/505 or Canadian Electrical Code, CSA C22; Providing intrinsically safe connections for Class I, Division 1, Groups A-G or Class I, Zone 0, Group IIC/IIB hazardous locations listed below.

Entity parameters for wiring configuration are on the next pages.

**Notes:**

- Intrinsically safe apparatus may be mV sources, thermocouples, CJCs, RTDs, potentiometers or an Approved System or Entity device connected in accordance with the manufacturer's installation instructions.
- For Entity concept use the appropriate parameters from above to ensure the following:  

$$V_{OC} \text{ or } V_t \leq V_{max} \quad C_a \geq C_i + C_{leads}$$

$$I_{SC} \text{ or } I_t \leq I_{max} \quad L_a \geq L_i + L_{leads}$$
- The values of  $L_a$  and  $C_a$  in the tables on the next sheets are the maximum values for combined inductance and capacitance (including cable inductance and capacitance). The values for  $L_a$  and  $C_a$  marked in grey are the values determined according to curves and tables of IEC 60079-11, Annex A. These grey marked values may be used for assessment as per IEC 60079-14, intrinsically safe circuits with only one source of power.
- Suitable separation must be maintained between wiring of each I.S. input channel.
- For Installation in Division 2 or Zone 2 see Certification drawing for IS1 resp. IS1+ Remote I/O System No. 9400 6 031 004 1 or 9400 6 031 006 1 as part of the documentation of the CPU & Power Modules.

			2016	Date	Name	Certification drawing		Scale
			Drawn by	25.10.	Bagusch	Temperature Input Module Type 9482/33-08-1*		none
			Checked		Kaiser			Sheet
						9482 6 031 002 1		1 of 4
01	09.03.2018	Bagusch				Agency		FM
Version	Date	Name	Rep. f.				Rep. t.	A4

Entity parameters for wiring configuration – Temperature Input Module Type 9482

General explanations:

Grounded - the channels are connected via a common ground together by installation.  
 Ungrounded - the channels are installed galvanically separated to each other and to ground

The source is linear in all applications.

If an  $U_i$  is applied at one channel, the  $U_i$  might occur in addition to  $U_o$  at another channel. Therefore the  $L_a$  and  $C_a$  values are calculated with  $V_{oc\ ext} = V_i + V_{oc}$ .

The stated  $V_i$  is a sum over all inputs.

Ungrounded only RTD and potentiometer

For connection of up to 8 passive, galvanically isolated and ungrounded I.S. circuits.

<b>2-Wire:</b>	Connector X1 / X2 – Channel 0 (1/4); Channel 1 (5/8) up to Channel 7 (29/32)													
Input	Voc = 6.42 V		Vi = n/a		Voc ext = n/a		Isc = 6.5 mA		Po = 10.5 mW					
<b>3-Wire:</b>	Connector X1 / X2 – Channel 0 (1/3/4); Channel 1 (5/7/8); up to Channel 7 (29/31/32)													
Input	Voc = 6.42 V		Vi = n/a		Voc ext = n/a		Isc = 7.8 mA		Po = 12.5 mW					
<b>4-Wire:</b>	Connector X1 / X2 – Channel 0 (1/2/3/4); Channel 1 (4/6/7/8); up to Channel 7 (29/30/31/32)													
Input	Voc = 6.42 V		Vi = n/a		Voc ext = n/a		Isc = 9.8 mA		Po = 15.7 mW					
	CL I, DIV 1, A,B / Zone 0, GP IIC							CL I, DIV 1, C-G / Zone 0, GP IIB/IIIC						
$L_a$ [mH]	100	50	20	2	0.2	0.02	0.002	100	50	20	2	0.2	0.02	0.002
$C_a$ [µF]	1.1	1.2	1.4	2.0	3.2	7.0	25	5.8	6.3	7.1	10	19	51	570

Ungrounded RTD or potentiometer connected in a mixed configuration with  $U_i$

For connection of up to 8 passive, galvanically isolated and ungrounded I.S. circuits. Thermocouples and external CJC circuit might also be connected, their calculation is below. Calculated with the following maximum values:

<b>2-Wire:</b>	Connector X1 / X2 – Channel 0 (1/4); Channel 1 (5/8) up to Channel 7 (29/32)													
Input	Voc = 6.42 V		<b>Vi = 6.5 V</b>		Voc ext = 12.92 V		Isc = 13.1 mA		Po = 42.2 mW					
<b>3-Wire:</b>	Connector X1 / X2 – Channel 0 (1/3/4); Channel 1 (5/7/8); up to Channel 7 (29/31/32)													
Input	Voc = 6.42 V		<b>Vi = 6.5 V</b>		Voc ext = 12.92 V		Isc = 15.7 mA		Po = 50.6 mW					
<b>4-Wire:</b>	Connector X1 / X2 – Channel 0 (1/2/3/4); Channel 1 (4/6/7/8); up to Channel 7 (29/30/31/32)													
Input	Voc = 6.42 V		<b>Vi = 6.5 V</b>		Voc ext = 12.92 V		Isc = 19.6 mA		Po = 63.3 mW					
	CL I, DIV 1, A,B / Zone 0, GP IIC							CL I, DIV 1, C-G / Zone 0, GP IIB/IIIC						
$L_a$ [mH]	100	50	20	5	1	0.5	0.2	100	20	10	2	1	0.5	0.1
$C_a$ [µF]	0.19	0.25	0.31	0.40	0.54	0.63	0.78	1.3	1.7	1.9	2.5	3.0	3.5	5.7

<b>2-Wire:</b>	Connector X1 / X2 – Channel 0 (1/4); Channel 1 (5/8) up to Channel 7 (29/32)													
Input	Voc = 6.42 V		<b>Vi = 3.5 V</b>		Voc ext = 9.92 V		Isc = 10 mA		Po = 24.9 mW					
<b>3-Wire:</b>	Connector X1 / X2 – Channel 0 (1/3/4); Channel 1 (5/7/8); up to Channel 7 (29/31/32)													
Input	Voc = 6.42 V		<b>Vi = 3.5 V</b>		Voc ext = 9.92 V		Isc = 12 mA		Po = 29.8 mW					
<b>4-Wire:</b>	Connector X1 / X2 – Channel 0 (1/2/3/4); Channel 1 (4/6/7/8); up to Channel 7 (29/30/31/32)													
Input	Voc = 6.42 V		<b>Vi = 3.5 V</b>		Voc ext = 9.92 V		Isc = 15 mA		Po = 37.3 mW					
	CL I, DIV 1, A,B / Zone 0, GP IIC							CL I, DIV 1, C-G / Zone 0, GP IIB/IIIC						
$L_a$ [mH]	100	50	20	1	0.1	0.05	0.02	100	50	20	1	0.1	0.05	0.02
$C_a$ [µF]	0.40	0.47	0.56	0.92	1.6	2.0	2.8	2.3	2.5	2.9	5.1	9.8	13	20

The copying, distribution and utilization of this document as well as the communication of its contents to others without expressed authorization is prohibited. Offenders will be held liable for the payment of damages. All rights reserved in the event of the grant of a patent, utility model or ornamental design registration.

F 4830 503

Weitergabe sowie Vervielfältigung dieses Dokuments, Verwertung und Mitteilung seines Inhalts sind verboten, soweit nicht ausdrücklich gestattet. Zuwiderhandlungen verpflichten zu Schadensersatz. Alle Rechte für den Fall der Patent-, Gebrauchsmuster- oder Geschmacksmusterrechte vorbehalten.

2016	Date	Name	Certification drawing						Scale
Drawn by	25.10.	Bagusch	Temperature Input Module Type 9482/33-08-1*						none
Checked		Kaiser							Sheet
			9482 6 031 002 1						2 of 4
									Agency
01	09.03.2018	Bagusch							FM
Version	Date	Name	Rep. f.					Rep. t.	A4

Grounded RTD or potentiometer connected in a mixed configuration with Vi

For connection of up to 8 passive I.S. circuits. Thermocouples and external CJC circuit might also be connected, their calculation is below. Calculated with the following maximum values:

<b>2-Wire:</b>	Connector X1 / X2 – Channel 0 (1/4); Channel 1 (5/8) up to Channel 7 (29/32)													
Input	Voc = 6.42 V	<b>Vi = 6.5 V</b>					Voc ext = 12.92 V	Isc = 47.9 mA	Po = 155 mW					
<b>3-Wire:</b>	Connector X1 / X2 – Channel 0 (1/3/4); Channel 1 (5/7/8); up to Channel 7 (29/31/32)													
Input	Voc = 6.42 V	<b>Vi = 6.5 V</b>					Voc ext = 12.92 V	Isc = 58.5 mA	Po = 189 mW					
<b>4-Wire:</b>	Connector X1 / X2 – Channel 0 (1/2/3/4); Channel 1 (4/6/7/8); up to Channel 7 (29/30/31/32)													
Input	Voc = 6.42 V	<b>Vi = 6.5 V</b>					Voc ext = 12.92 V	Isc = 68.8 mA	Po = 222 mW					
	CL I, DIV 1, A,B / Zone 0, GP IIC							CL I, DIV 1, C-G / Zone 0, GP IIB/IIIC						
La [mH]	9	5	2	1	0.5	0.2	0.1	40	20	10	5	1	0.5	0.1
Ca [µF]	0.23	0.31	0.41	0.50	0.60	0.76	0.93	0.94	1.3	1.6	1.9	2.9	3.4	5.6

<b>2-Wire:</b>	Connector X1 / X2 – Channel 0 (1/4); Channel 1 (5/8) up to Channel 7 (29/32)													
Input	Voc = 6.42 V	<b>Vi = 3.5 V</b>					Voc ext = 9.92 V	Isc = 36.6 mA	Po = 91 mW					
<b>3-Wire:</b>	Connector X1 / X2 – Channel 0 (1/3/4); Channel 1 (5/7/8); up to Channel 7 (29/31/32)													
Input	Voc = 6.42 V	<b>Vi = 3.5 V</b>					Voc ext = 9.92 V	Isc = 44.8 mA	Po = 111 mW					
<b>4-Wire:</b>	Connector X1 / X2 – Channel 0 (1/2/3/4); Channel 1 (4/6/7/8); up to Channel 7 (29/30/31/32)													
Input	Voc = 6.42 V	<b>Vi = 3.5 V</b>					Voc ext = 9.92 V	Isc = 52.6 mA	Po = 131 mW					
	CL I, DIV 1, A,B / Zone 0, GP IIC							CL I, DIV 1, C-G / Zone 0, GP IIB/IIIC						
La [mH]	17	10	5	2	1	0.2	0.02	71	50	10	2	1	0.2	0.02
Ca [µF]	0.34	0.46	0.58	0.74	0.78	1.3	2.8	1.4	1.8	2.9	4.2	4.9	7.8	20

Ungrounded Thermocouple and mV Sources in a mixed configuration with Vi

For connection of up to 8 passive or active, galvanically isolated and ungrounded I.S. circuits. RTD and potentiometer might also be connected, their calculation is above. The external CJC might also be connected, the calculation is below. Calculated with the following maximum values:

	Connector X1 / X2 – Channel 0 (2/3); Channel 1 (6/7) up to Channel 7 (30/31)													
Input	Voc = 6.42 V	<b>Vi = 6.5 V</b>					Voc ext = 12.92 V	Isc = 6.53 mA	Po = 21.1 mW					
	CL I, DIV 1, A,B / Zone 0, GP IIC							CL I, DIV 1, C-G / Zone 0, GP IIB/IIIC						
La [mH]	100	50	10	5	1	0.5	0.2	100	50	10	1	0.5	0.2	0.1
Ca [µF]	0.30	0.32	0.38	0.42	0.55	0.63	0.79	1.5	1.6	1.9	3.0	3.5	4.6	5.7

Grounded Thermocouple and mV Sources in a mixed configuration with Vi

For connection of up to 8 passive or active I.S. circuits. RTD and potentiometer might also be connected, their calculation is above. The external CJC might also be connected, the calculation is below. Calculated with the following maximum values:

	Connector X1 / X2 – Channel 0 (2/3); Channel 1 (6/7) up to Channel 7 (30/31)													
Input	Voc = 6.42 V	<b>Vi = 6.5 V</b>					Voc ext = 12.92 V	Isc = 25 mA	Po = 81 mW					
	CL I, DIV 1, A,B / Zone 0, GP IIC							CL I, DIV 1, C-G / Zone 0, GP IIB/IIIC						
La [mH]	72	50	10	2	1	0.5	0.2	100	20	5	1	0.5	0.2	0.1
Ca [µF]	0.17	0.22	0.34	0.46	0.53	0.62	0.78	1.2	1.6	2.1	3.0	3.5	4.5	5.7

	Connector X1 / X2 – Channel 0 (2/3); Channel 1 (6/7) up to Channel 7 (30/31)													
Input	Voc = 6.42 V	<b>Vi = 3.5 V</b>					Voc ext = 9.92 V	Isc = 19.2 mA	Po = 48 mW					
	CL I, DIV 1, A,B / Zone 0, GP IIC							CL I, DIV 1, C-G / Zone 0, GP IIB/IIIC						
La [mH]	100	50	10	2	1	0.2	0.02	100	20	5	1	0.5	0.1	0.02
Ca [µF]	0.33	0.43	0.60	0.80	0.92	1.3	2.8	2.2	2.9	3.6	5.0	6	9.8	20

The copying, distribution and utilization of this document as well as the communication of its contents to others without expressed authorization is prohibited. Offenders will be held liable for the payment of damages. All rights reserved in the event of the grant of a patent, utility model or ornamental design registration.

F 4830 503

Weitergabe sowie Vervielfältigung dieses Dokuments, Verwertung und Mitteilung seines Inhalts sind verboten, soweit nicht ausdrücklich gestattet. Zuwiderhandlungen verpflichten zu Schadensersatz. Alle Rechte für den Fall der Patent-, Gebrauchsmuster- oder Geschmacksmusterrechte vorbehalten.

			2016	Date	Name	Certification drawing						Scale
			Drawn by	25.10.	Bagusch	Temperature Input Module Type 9482/33-08-1*						none
			Checked		Kaiser							Sheet
						9482 6 031 002 1						3 of 4
												Agency
01	09.03.2018	Bagusch				9482 6 031 002 1						FM
Version	Date	Name										Rep. f.

Ungrounded RTD for external CJC connected in a mixed configuration with Vi

For connection of up to 8 passive, galvanically isolated and ungrounded I.S. circuits. Thermocouples and RTD and potentiometer might also be connected, their calculation is above. Calculated with the following maximum values:

<b>2-Wire:</b>	Connector X2 – Channel 6 and 7 (25/32)													
Input	Voc = 6.42 V	<b>Vi = 6.5 V</b>			Voc ext = 12.92 V			Isc = 13.1 mA			Po = 43 mW			
<b>3-Wire:</b>	Connector X2 – Channel 6 and 7 (25/29/32)													
Input	Voc = 6.42 V	<b>Vi = 6.5 V</b>			Voc ext = 12.92 V			Isc = 17.4 mA			Po = 56.2 mW			
<b>4-Wire:</b>	Connector X2 – Channel 6 and 7 (25/28/29/32)													
Input	Voc = 6.42 V	<b>Vi = 6.5 V</b>			Voc ext = 12.92 V			Isc = 26.1 mA			Po = 84.3 mW			
	CL I, DIV 1, A,B / Zone 0, GP IIC							CL I, DIV 1, C-G / Zone 0, GP IIB/IIIC						
L <sub>a</sub> [mH]	66	50	20	5	1	0.5	0.2	100	20	5	1	0.5	0.2	0.1
C <sub>a</sub> [µF]	0.17	0.21	0.29	0.39	0.53	0.62	0.78	1.2	1.6	2.1	2.9	3.5	4.5	5.7

<b>2-Wire:</b>	Connector X2 – Channel 6 and 7 (25/32)													
Input	Voc = 6.42 V	<b>Vi = 3.5 V</b>			Voc ext = 9.92 V			Isc = 10 mA			Po = 24.9 mW			
<b>3-Wire:</b>	Connector X2 – Channel 6 and 7 (25/29/32)													
Input	Voc = 6.42 V	<b>Vi = 3.5 V</b>			Voc ext = 9.92 V			Isc = 13.4 mA			Po = 33.2 mW			
<b>4-Wire:</b>	Connector X2 – Channel 6 and 7 (25/28/29/32)													
Input	Voc = 6.42 V	<b>Vi = 3.5 V</b>			Voc ext = 9.92 V			Isc = 20.1 mA			Po = 49.7 mW			
	CL I, DIV 1, A,B / Zone 0, GP IIC							CL I, DIV 1, C-G / Zone 0, GP IIB/IIIC						
L <sub>a</sub> [mH]	100	50	10	2	1	0.2	0.02	100	20	5	1	0.5	0.1	0.02
C <sub>a</sub> [µF]	0.31	0.43	0.60	0.80	0.91	1.3	2.8	2.2	2.8	3.6	5.0	6	9.8	20

Grounded RTD for external CJC connected in a mixed configuration with Vi

For connection of up to 8 passive I.S. circuits. Thermocouples and RTD and potentiometer might also be connected, their calculation is above. Calculated with the following maximum values:

<b>2-Wire:</b>	Connector X2 – Channel 6 and 7 (25/32)													
Input	Voc = 6.42 V	<b>Vi = 6.5 V</b>			Voc ext = 12.92 V			Isc = 47.9 mA			Po = 155 mW			
<b>3-Wire:</b>	Connector X2 – Channel 6 and 7 (25/29/32)													
Input	Voc = 6.42 V	<b>Vi = 6.5 V</b>			Voc ext = 12.92 V			Isc = 68.6 mA			Po = 222 mW			
<b>4-Wire:</b>	Connector X2 – Channel 6 and 7 (25/28/29/32)													
Input	Voc = 6.42 V	<b>Vi = 6.5 V</b>			Voc ext = 12.92 V			Isc = 87.1 mA			Po = 281.1 mW			
	CL I, DIV 1, A,B / Zone 0, GP IIC							CL I, DIV 1, C-G / Zone 0, GP IIB/IIIC						
L <sub>a</sub> [mH]	5.6	5	2	1	0.5	0.2	0.1	25	20	10	5	1	0.5	0.1
C <sub>a</sub> [µF]	0.25	0.27	0.39	0.48	0.58	0.75	0.92	1	1.1	1.5	1.9	2.8	3.4	5.6

<b>2-Wire:</b>	Connector X2 – Channel 6 and 7 (25/32)													
Input	Voc = 6.42 V	<b>Vi = 3.5 V</b>			Voc ext = 9.92 V			Isc = 36.8 mA			Po = 91.1 mW			
<b>3-Wire:</b>	Connector X2 – Channel 6 and 7 (25/29/32)													
Input	Voc = 6.42 V	<b>Vi = 3.5 V</b>			Voc ext = 9.92 V			Isc = 52.6 mA			Po = 131 mW			
<b>4-Wire:</b>	Connector X2 – Channel 6 and 7 (25/28/29/32)													
Input	Voc = 6.42 V	<b>Vi = 3.5 V</b>			Voc ext = 9.92 V			Isc = 66.8 mA			Po = 166 mW			
	CL I, DIV 1, A,B / Zone 0, GP IIC							CL I, DIV 1, C-G / Zone 0, GP IIB/IIIC						
L <sub>a</sub> [mH]	10	5	2	1	0.2	0.1	0.02	44	20	10	2	1	0.1	0.02
C <sub>a</sub> [µF]	0.37	0.53	0.71	0.85	1.3	1.6	2.8	1.5	2.3	2.8	4.1	4.9	9.8	20

The copying, distribution and utilization of this document as well as the communication of its contents to others without expressed authorization is prohibited. Offenders will be held liable for the payment of damages. All rights reserved in the event of the grant of a patent, utility model or ornamental design registration.

F 4830 503

Weitergabe sowie Vervielfältigung dieses Dokuments, Verwertung und Mitteilung seines Inhalts sind verboten, soweit nicht ausdrücklich gestattet. Zuwiderhandlungen verpflichten zu Schadensersatz. Alle Rechte für den Fall der Patent-, Gebrauchsmuster- oder Geschmacksmustereintragung vorbehalten.

			2016	Date	Name	Certification drawing						Scale
			Drawn by	25.10.	Bagusch	Temperature Input Module Type 9482/33-08-1*						none
			Checked		Kaiser							Sheet
						9482 6 031 002 1						4 of 4
												Agency
01	09.03.2018	Bagusch				9482 6 031 002 1						FM
Version	Date	Name										Rep. f.