



Visual signalling device

Series FL60

Contents

1	General information	3
1.1	Manufacturer	3
1.2	Information regarding the operating instructions.....	3
1.3	Further documents.....	3
1.4	Conformity with standards and regulations.....	3
2	Explanation of symbols	3
2.1	Symbols used in these operating instructions.....	3
2.2	Warning notes.....	4
2.3	Symbols on the device.....	5
3	Safety notes	6
3.1	Operating instructions storage	6
3.2	Personnel qualification.....	6
3.3	Safe use.....	6
3.4	Modifications and alterations	7
4	Function and device design	7
4.1	Function	7
5	Technical data.....	8
6	Transport and storage.....	10
7	Mounting and installation	11
7.1	Dimensions/fastening dimensions	11
7.2	Mounting/dismounting, operating position	12
7.3	Installation.....	13
8	Commissioning	18
9	Operation	18
9.1	Troubleshooting	18
10	Maintenance, overhaul, repair	19
10.1	Maintenance and overhaul.....	19
10.2	Repairs.....	19
10.3	Returning the device	20
11	Cleaning.....	20
12	Disposal	20
13	Accessories and spare parts.....	20

1 General information

1.1 Manufacturer

R. STAHL Schaltgeräte GmbH
Business Unit Lighting & Signalling
Nordstr. 10
99427 Weimar
Germany

Tel.: +49 3643 4324
Fax: +49 3643 4221-76
Internet: r-stahl.com
E-mail: info@r-stahl.com

R. STAHL Schaltgeräte GmbH
Am Bahnhof 30
74638 Waldenburg
Germany

Tel.: +49 7942 943-0
Fax: +49 7942 943-4333
Internet: r-stahl.com
E-mail: info@r-stahl.com

1.2 Information regarding the operating instructions

ID no.: 223845 / FL6060300010
Publication code: 2022-07-11·BA00·III·en·06

1.3 Further documents



- Data sheet
- For documents in other languages, see r-stahl.com.



1.4 Conformity with standards and regulations

IECEX, ATEX, EU Declaration of Conformity and further national certificates can be downloaded via the following link: <https://r-stahl.com/en/global/support/downloads/>.
IECEX is also available at: <http://iecex.iec.ch/>

2 Explanation of symbols

2.1 Symbols used in these operating instructions



Symbol	Meaning
	Tips and recommendations on the use of the device
	General danger
	Danger due to explosive atmosphere

-  = Flashing beacon
-  = Earth connection
-  = Telephone connection







2.2 Warning notes

Warning notes must be observed under all circumstances, in order to minimise the risk resulting from design engineering and operation. The warning notes have the following structure:

- Signalling word: DANGER, WARNING, CAUTION, NOTICE
- Type and source of danger/damage
- Consequences of danger
- Taking countermeasures to avoid the danger or damage

	DANGER
	Danger to persons Non-compliance with the instruction results in severe or fatal injuries to persons.
	WARNING
	Danger to persons Non-compliance with the instruction can result in severe or fatal injuries to persons.
	CAUTION
	Danger to persons Non-compliance with the instruction can result in light injuries to persons.
NOTICE	
Avoiding material damage Non-compliance with these instructions can result in material damage to the device and/or its surroundings.	

2.3 Symbols on the device

Symbol	Meaning
 05594E00	CE marking according to the current applicable directive.
 02198E00	Device certified for hazardous areas according to the marking.
 15649E00	Input
 15648E00	Output
 11048E00	Safety notes that must always be observed: The corresponding data and/or safety-related instructions contained in the operating instructions must be followed for devices with this symbol!
 20690E00	Marking according to WEEE Directive 2012/19/EU

3 Safety notes

3.1 Operating instructions storage

- Carefully read the operating instructions.
- Store the operating instructions at the mounting location of the device.
- Observe applicable documents and operating instructions of the devices to be connected.

3.2 Personnel qualification

Qualified specialist personnel is required to perform the activities described in these operating instructions. This primarily applies to work in the following areas

- Project engineering
- Mounting/dismounting the device
- (Electrical) installation
- Commissioning
- Maintenance, repair, cleaning

Specialists who perform these activities must have a level of knowledge that meets applicable national standards and regulations.

Additional knowledge is required for any activity in hazardous areas!

R. STAHL recommends having a level of knowledge equal to that described in the following standards:

- IEC/EN 60079-14 (Project engineering, selection and construction of electrical systems)
- IEC/EN 60079-17 (Electrical Installations Inspection and Maintenance)
- IEC/EN 60079-19 (Equipment repair, overhaul and reclamation)

3.3 Safe use

Before mounting

- Read and observe the safety notes in these operating instructions!
- Ensure that the contents of these operating instructions are fully understood by the personnel in charge.
- Use the device in accordance with its intended and approved purpose only.
- Always consult R. STAHL Schaltgeräte GmbH if using the device under operating conditions which are not covered by the technical data.
- Make sure that the device is not damaged.
- We cannot be held liable for damage to the device caused by incorrect or unauthorised use or non-compliance with these operating instructions.



For mounting and installation

- Have mounting and installation performed only by qualified and authorised persons (see chapter "Personnel qualification").
- The device is only to be installed in areas for which it is suited based on its marking.
- During installation and operation, observe the information (characteristic values and rated operating conditions) on the rating, data and information plates located on the device.
- Before installation, make sure that the device is not damaged.

Commissioning, maintenance, repair

- Only have commissioning and repairs performed by qualified and authorised persons (see chapter "Personnel qualification").
- Before commissioning, make sure that the device is not damaged.
- Perform only maintenance work described in these operating instructions.

3.4 Modifications and alterations

	DANGER
	Explosion hazard due to modifications and alterations to the device! Non-compliance results in severe or fatal injuries. <ul style="list-style-type: none"> • Do not modify or change the device.
	No liability or warranty for damage resulting from modifications and alterations.

4 Function and device design

	DANGER
	Explosion hazard due to improper use! Non-compliance results in severe or fatal injuries. <ul style="list-style-type: none"> • Use the device only according to the operating conditions described in these operating instructions. • Use the device only for the intended purpose specified in these operating instructions.

4.1 Function**Application range**

The series FL60 explosion-protected visual signalling device is intended for use in hazardous area or in harsh environments.

It can be used in hazardous areas according to ATEX/IECEX in Zones 1 and 2 of gas group IIB or IIB + H2 or in Zones 21 and 22 for dust group IIC as well as in safe areas. The UL-certified variants can be used in areas according to Class I Division 1 for gas groups B, C and D, and Class II Division 1 for gas groups E, F and G, as well as in safe areas.

Mode of operation

When activated, the signalling device emits a visual signal, depending on the configuration and device version.

5 Technical data

Explosion protection

Global (IECEX)

Gas and dust

IIB+H2	IECEX BAS 05.0087X
IIB	IECEX BAS 05.0086X
IIB+H2, IIB	IEC 60079-0:2011 / IEC 60079-1:2014-06 / IEC 60079-31:2013
IIB+H2	Ex db IIB + H2 T4 Ta -20 to +60 °C Gb Ex tb IIIC T135 °C Ta -20 to +60 °C Db IP66 Ex db IIB + H2 T6 Ta -20 to +40 °C Gb Ex tb IIIC T85 °C Ta -20 to +40 °C Db IP66
IIB	Ex db IIB T4 Ta -35 to +60 °C Gb Ex tb IIIC T135 °C Ta -35 to +60 °C Db IP66 Ex db IIB T6 Ta -35 to +40 °C Gb Ex tb IIIC T85 °C Ta -35 to +40 °C Db IP66

Europe (ATEX)

Gas and dust

IIB+H2	Baseefa02ATEX0222X
IIB	Baseefa02ATEX0212X
IIB+H2, IIB	EN 60079-0:2012 + A11:2013 / EN 60079-1:2014 / EN 60079-31:2014
IIB+H2	⊕ II 2 G Ex db IIB + H2 T4 Ta -20 to +60 °C Gb ⊕ II 2 D Ex tb IIIC T135 °C Ta -20 to +60 °C Db IP66 ⊕ II 2 G Ex db IIB + H2 T6 Ta -20 to +40 °C Gb ⊕ II 2 D Ex tb IIIC T85 °C Ta -20 to +40 °C Db IP66
IIB	⊕ II 2 G Ex db IIB T4 Ta -35 to +60 °C Gb ⊕ II 2 D Ex tb IIIC T135 °C Ta -35 to +60 °C Db IP66 ⊕ II 2 G Ex db IIB T6 Ta -35 to +40 °C Gb ⊕ II 2 D Ex tb IIIC T85 °C Ta -35 to +40 °C Db IP66

North America (cULus-certified)

Gas and dust

IIB+H2, IIB	E188831
IIB+H2, IIB	USL: UL 60079-0 / UL 60079-1 / UL 1203 / UL 1638 CSA: CSA C22.2 No. 30-M1986 / CSA C22.2 No. 25-M1966 / CSA 60079-0 / CSA 60079-1
IIB+H2	CLASS I, DIVISION 1, GROUPS B, C and D; CLASS II, DIVISION 1, GROUPS E, F and G; CLASS III CLASS I, ZONE 1 AEx d IIB+H2 T4 Gb CLASS I, ZONE 1 Ex d IIB+H2 T4 Gb (Approval for models: FL60 - B - D50 - A/B/C/G/O/R/Y -UL) Ta -25 to +66 °C

Certifications and certificates

Certifications

IECEX, ATEX, Brazil, India, Kazakhstan, Russia, Taiwan, USA & Canada, Belarus

Functional safety (IEC 61508)

Test report

SIL 1 IEC61508-2:2010

Technical data

Technical data

Product weight | 5.08 kg

Electrical data

Rated operational voltage | 24 V DC, 115 V AC, 230 V AC
Operational parameters +/- 10%

Rated operational current	24 V DC	5 J	220 mA
	115 V AC	5 J	90 mA
		10 J	105 mA
20 J		260 mA	
230 V AC	5 J	45 mA	
	10 J	53 mA	
	20 J	170 mA	

Ambient conditions

Functional ambient temperature range | Depends on the variant, see explosion protection

Mechanical data

Degree of protection | IP66 (IEC/EN 60529)
NEMA 4X (UL 50)

Material

Enclosure | Aluminium 6005A - T6, seawater-resistant

Calotte cover | Polycarbonate

Mounting | Stainless steel

Cable entries

ATEX/IECEx variant

2 x M10 cable entries, equipped with:

1 x Ex d M20 stopping plug

1 x M20 dust cap, red

UL variant

1 x CMP-757 VST Ms M20

1 x adapter M20x1/2" NPT CSA

1 x dust cap

Technical data

Luminous characteristics

Effective luminous intensity	5 J		
	Clear lens	46 cd	
	Yellow lens	42 cd	
	Amber lens	28 cd	
	Red lens	14 cd	
	Blue lens	13 cd	
	Green lens	10 cd	
	Magenta lens	N/A	
	10 J		
	Clear lens	127 cd	
20 J			
Clear lens	265 cd		
Light quantity	5 J	9.3 lm s	Clear lens
	10 J	25 lm s	Clear lens
	20 J	53 lm s	Clear lens
Flash energy	5, 10, 20 J		
Flash rate	60 FPM		
Service life	Variant	Number of flashes	
	5 J	2 million	
	10 J	5 million	
	20 J	4 million	

For further technical data, see r-stahl.com.

6 Transport and storage

- Transport and store the device only in the original packaging.
- Store the device in a dry place (no condensation) free of vibrations.
- Do not drop the device.

7 Mounting and installation

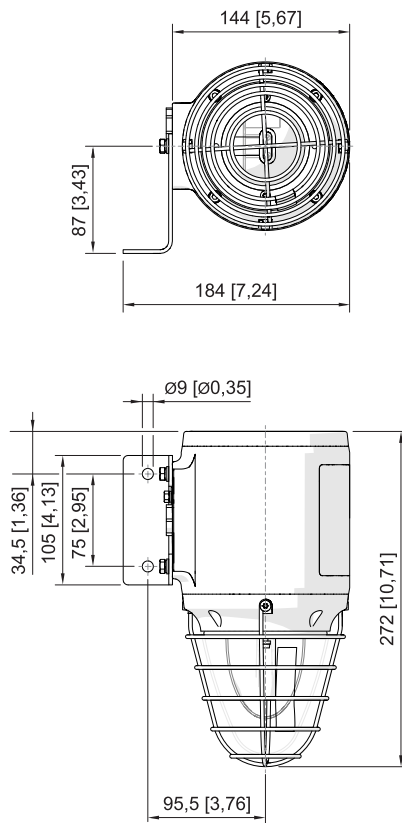

7.1 Dimensions/fastening dimensions

Dimensional drawings (all dimensions in mm [inch]) – Subject to change



18381E00

7.2 Mounting/dismounting, operating position

	<p style="text-align: center;">DANGER</p> <p>Explosion hazard due to improper mounting! Non-compliance results in severe or fatal injuries.</p> <ul style="list-style-type: none"> • Only operate the device if it is not damaged. If the thread is damaged, replace the device immediately. • Only install the device in a clean and dry operating environment. • Only mount the device on a wall or on a suitable surface. • Carefully protect exposed joint surfaces from damage, dust and dirt. • Install end flanges without applying force (without hammer and tool) in straight alignment. • If necessary, fit core end sleeves gas-tight and using a suitable tool.
	<p style="text-align: center;">DANGER</p> <p>Explosion hazard due to electrostatic discharge! Non-compliance results in severe or fatal injuries.</p> <p>Do not use the device in strong charge-generating environments!</p> <p>The following processes/activities should be avoided:</p> <ul style="list-style-type: none"> • Accidental friction • Particle flows
	<p style="text-align: center;">DANGER</p> <p>Explosion hazard due to open drilled holes, unused cable entries and cable glands! Non-compliance results in severe or fatal injuries.</p> <ul style="list-style-type: none"> • Only use cable entries and stopping plugs that have been separately checked and certified in accordance with Directive 2014/34/EU (ATEX) and IECEx (CoC), and which technically correspond to the state of technology given in the certificate. • The IP level of protection of the cable entries and stopping plugs must at least correspond to the IP level of protection of the device (see marking on the device). • When selecting cable entries, observe the type of thread and thread size in the component documentation. • Seal the thread with non-curing thread sealant in order to guarantee the IP66 degree of protection. • Always close unused drilled holes, cable entries and cable glands using approved stopping plugs or plugs. Observe IEC/EN 60079-14 for this. • Installation of the cable gland must be performed in accordance with the manufacturer's instructions. • The cable entry temperature may exceed 70 °C.

- Mount the device on a flat surface suitable for its weight.
- Insert the electrical lines using a certified and flameproof cable entry which is suitable for the gas group.
- Close unused entries using certified, flameproof stopping plugs.

7.3 Installation

The electrical installation and configuration of the device is performed in the following sequence:

- Dismounting the device (see chapter 7.3.1)
- Electrical connections (see chapter 7.3.2)
- Mounting the device (see chapter 7.3.3)
- Mounting the earth connection (see chapter 7.3.4)

7.3.1 Dismounting the device

<p style="text-align: right; font-size: small;">16439E00</p>	<ul style="list-style-type: none"> • Remove the four cheese-head screws (1) with Nyltite seal (2). • Carefully lift the end cap (3). • Lift the PCB (4) far enough that the connection terminals are exposed (see circuit diagrams) • Loosen the connection terminals and carefully set the enclosure (5) aside.
--	--

- 1 Cheese-head screw
- 2 Nyltite seal
- 3 End cap

- 4 PCB
- 5 Enclosure

7.3.2 Electrical connections

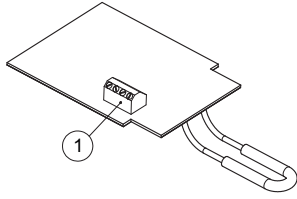

FL60 DC (5 J)

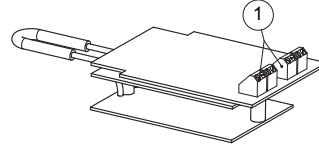

16440E00

FL60 AC (5 J)

16441E00

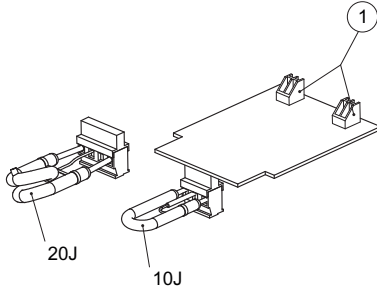

16443E00

FL60 DC, AC (10 J, 20 J)

1 Terminal blocks

Cable connection

	<ul style="list-style-type: none"> • Approx. 20 cm (8 inch) of electrical line are required for the connection of the circuit board within the enclosure. This is particularly important for installing a rigid cable. • The connection terminal is suitable for cables with a cross section of 2.5 mm² or 14 to 18 AWG.
---	---

Parallel connection of several devices

Up to 10 devices can be connected to a supply line in parallel.

Circuit diagrams

DC version

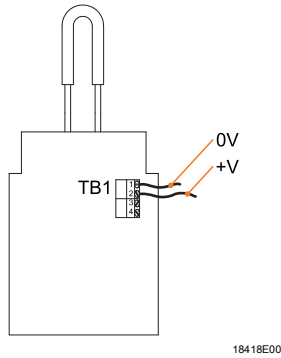

FL60 DC 5 J

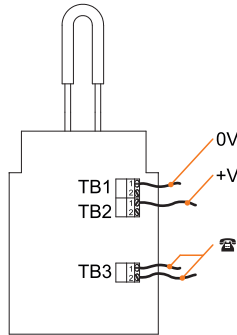

**FL60 DC 5 J
Telephone initiate**

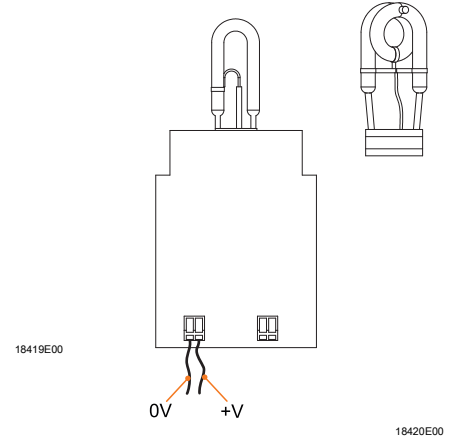

FL60 DC 10/20 J

AC version

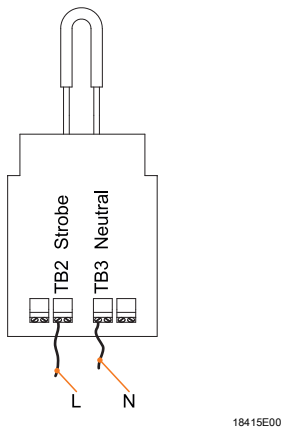

FL60 AC 5 J

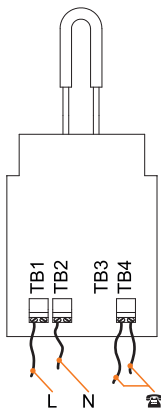

**FL60 AC 5 J
Telephone initiate**

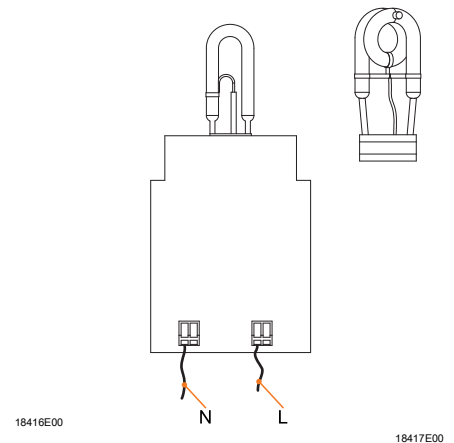

FL60 AC 10/20 J

7.3.3 Mounting the device

Inserting the PCB

The correct position of the PCB is indicated by two grooves.

Depending on the version, however, they can be in different positions as shown in the figure.

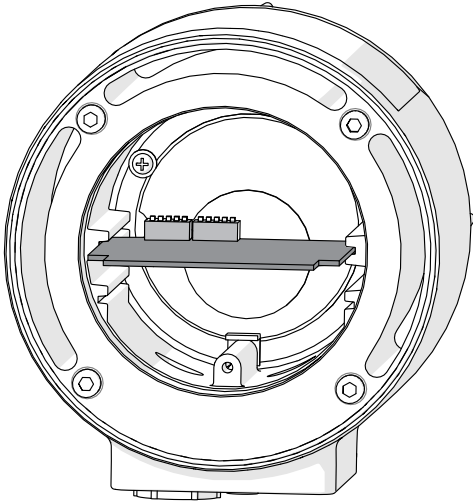

18814E00

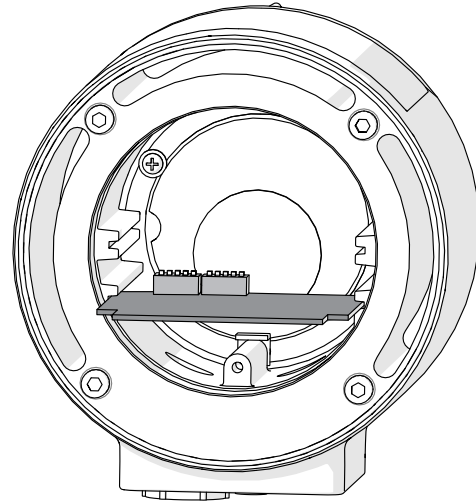

18813E00

- FL60/.D50/./..
 - FL60/.F50/./..
 - FL60/.L50/./..
 - FL60/.L100/./..
 - FL60/.L200/./..
 - FL60/.N50/./..
 - FL60/.N100/./..
 - FL60/.N200/./..
- With the electrical lines connected, carefully insert the PCB back into the grooves in the enclosure until it is once again in the correct position.
 - When doing so, ensure that the flash tube is clearly visible and centrally located in the glass dome.
 - Slowly and carefully insert the end cap directly into the enclosure without applying force.
 - Replace the M5 x 16 cheese-head screws (see information below) and tighten them to a tightening torque of 3 Nm.



Screws and seals

The cheese-head screws are delivered with Nyltite seals.

- Before mounting, check the seals for damage.
- Replace damaged seals.
- Use seals a maximum of 5 times.
- When using screws on a flat surface, note the seal on the screw head – see figure.

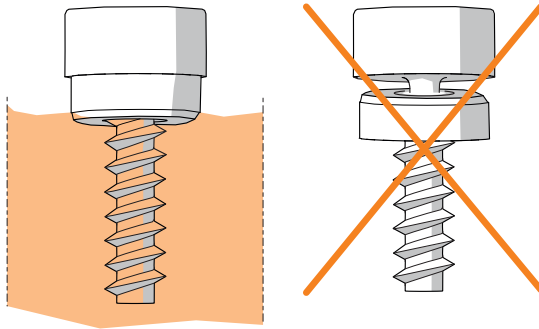

15748E00

7.3.4 Mounting the earth connection

- The device must be provided with a good quality earth connection.
- The internal earth connection is the primary connection point. The external connection is an additional equipotential bonding conductor and is used where local code or authorities permit or require such a conductor.

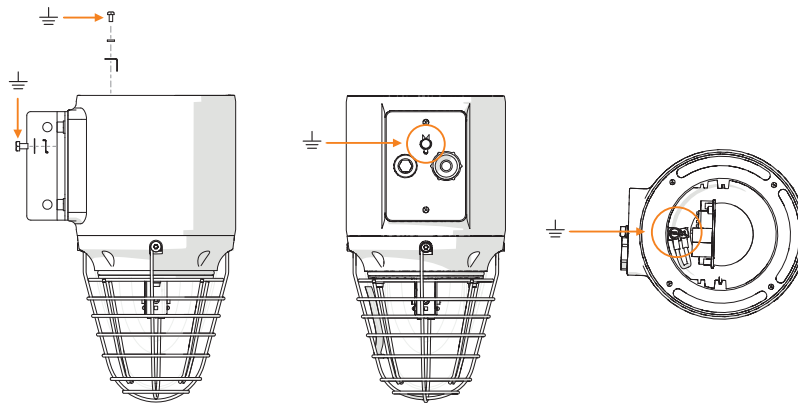

22992E00

8 Commissioning

	DANGER
	<p>Explosion hazard due to incorrect installation! Non-compliance results in severe or fatal injuries.</p> <ul style="list-style-type: none"> • Check the device for proper installation before commissioning. • Comply with national regulations.

Before commissioning, ensure that:

- the device has been installed according to regulations.
- the line voltage and the rated operational voltage of the device are consistent.
- the permissible cable diameter for the cable entries has been used.
- the cable entries and stopping plugs have been securely tightened.
- the electrical lines have been inserted correctly.
- the connection has been performed correctly.
- all screws and nuts have been tightened according to regulations.
- the connection chamber is clean.
- the device is not damaged.
- there are no foreign objects inside the device.
- the device is closed according to regulations.

9 Operation

The device is used to warn and alert by means of

- a visual signal.

9.1 Troubleshooting

If an error occurs please re-visit the earlier sections of this document.

If the error cannot be eliminated using the specified procedures:

- Contact R. STAHL Schaltgeräte GmbH.

For rapid processing, have the following information ready:

- Type and serial number of the device
- Purchase information
- Error description
- Intended purpose (especially input/output circuit)

10 Maintenance, overhaul, repair

10.1 Maintenance and overhaul

- Consult the relevant national regulations to determine the type and extent of inspections.
- Tailor inspection intervals to the operating conditions.
- Perform maintenance and repair work in accordance with IEC 60079-17 and IEC 60079-19.

	Observe the relevant national regulations in the country of use.
---	--

At a minimum, check the following points during maintenance on the device:

- Whether the clamping screws holding the electrical lines fit securely
- Whether the device has cracks or other visible signs of damage
- Whether the seals have aged or been damaged
- Whether the permissible temperatures are complied with (according to EN 60079)
- Whether the device is used as intended and functions properly

10.2 Repairs

	DANGER
	<p>Explosion hazard due to improper repair! Non-compliance results in severe or fatal injuries.</p> <ul style="list-style-type: none"> • Repair work on the devices must be performed only by R. STAHL Schaltgeräte GmbH.

10.3 Returning the device

- Only return or package the devices after consulting R. STAHL!
Contact the responsible representative from R. STAHL.

R. STAHL's customer service is available to handle returns if repair or service is required.

- Contact customer service personally.

or

- Go to the r-stahl.com website.
- Under "Support" > "RMA" > select "RMA-REQUEST".
- Fill out the form and send it.
You will automatically receive an RMA form via email. Please print this file off.
- Send the device along with the RMA form in the packaging to
R. STAHL Schaltgeräte GmbH (refer to chapter 1.1 for the address).

11 Cleaning

- Devices located in hazardous areas may only be cleaned with a damp cloth to avoid electrostatic charge.
- When cleaning with a damp cloth, use water or mild, non-abrasive, non-scratching cleaning agents.
- Do not use abrasive cleaning agents or solvents.

12 Disposal

- Observe national, local and statutory regulations regarding disposal.
- Separate materials for recycling.
- Ensure environmentally friendly disposal of all components according to statutory regulations.

13 Accessories and spare parts

NOTICE

Malfunction or damage to the device due to the use of non-original components.
Non-compliance may lead to material damage!

- Use only original accessories and spare parts from R. STAHL Schaltgeräte GmbH.



For accessories and spare parts, see the data sheet on our homepage r-stahl.com.

EU-Konformitätserklärung
EU Declaration of Conformity
Déclaration de Conformité UE



R. STAHL Schaltgeräte GmbH • Am Bahnhof 30 • 74638 Waldenburg, Germany
 erklärt in alleiniger Verantwortung, *declares in its sole responsibility, déclare sous sa seule responsabilité,*

dass das Produkt: **Akustische und optische Signalgeräte**
that the product: Audible and visual signalling devices
que le produit: Appareil de signalisation sonore et lumineux

Typ(en), type(s), type(s): **YL60/B, YA60/B, FL60/B**

mit den Anforderungen der folgenden Richtlinien und Normen übereinstimmt.
is in conformity with the requirements of the following directives and standards.
est conforme aux exigences des directives et des normes suivantes.

Richtlinie(n) / Directive(s) / Directive(s)	Norm(en) / Standard(s) / Norme(s)
---	-----------------------------------

2014/34/EU ATEX-Richtlinie 2014/34/EU <i>ATEX Directive</i> 2014/34/UE <i>Directive ATEX</i>	EN 60079-0:2012 + A11:2013 EN 60079-1:2014 EN 60079-31:2014
---	---

Kennzeichnung, marking, marquage: **II 2 G Ex db IIB T4/ T6 Gb** **0158**
 II 2 D Ex tb IIIC T135 °C/ T85 °C Db

EU-Baumusterprüfbescheinigung: **Baseefa 02 ATEX 0212 X**
EU Type Examination Certificate: (SGS Fimko Oy,
Attestation d'examen UE de type: Särkiniementie 3, P.O. Box 30, FI-00211 Helsinki, Finland)

Produktnormen nach Niederspannungsrichtlinie: <i>Product standards according to Low Voltage Directive:</i> <i>Normes des produit pour la Directive Basse Tension:</i>	EN 60598-1:2015 + A1:2018 EN 62471:2008
--	--

2014/30/EU EMV-Richtlinie 2014/30/EU <i>EMC Directive</i> 2014/30/UE <i>Directive CEM</i>	EN 50130-4:2011 + A1:2014 EN 61000-3-2:2014 EN 61000-3-3:2013 EN 61000-6-4:2007 + A1:2011
--	--

2011/65/EU RoHS-Richtlinie 2011/65/EU <i>RoHS Directive</i> 2011/65/UE <i>Directive RoHS</i>	EN IEC 63000:2018
---	-------------------

Waldenburg, 2021-03-22

Ort und Datum
Place and date
Lieu et date

i.V.

Dr. C. Chevalier
Vice President BU Lighting & Signalling
Vice-Président BU Eclairage & Appareils de signalisation

i.V.

J. Freimüller
Vice President global Quality Management
Vice-Président globale Gestion de Qualité

EU-Konformitätserklärung
EU Declaration of Conformity
Déclaration de Conformité UE



R. STAHL Schaltgeräte GmbH • Am Bahnhof 30 • 74638 Waldenburg, Germany
 erklärt in alleiniger Verantwortung, *declares in its sole responsibility, déclare sous sa seule responsabilité,*

dass das Produkt: <i>that the product:</i> <i>que le produit:</i>	Akustische und optische Signalgeräte <i>Audible and visual signalling devices</i> <i>Appareil de signalisation sonore et lumineux</i>
Typ(en), type(s), type(s):	YL60/C, YA60/C, FL60/C
mit den Anforderungen der folgenden Richtlinien und Normen übereinstimmt. <i>is in conformity with the requirements of the following directives and standards.</i> <i>est conforme aux exigences des directives et des normes suivantes.</i>	
Richtlinie(n) / Directive(s) / Directive(s)	Norm(en) / Standard(s) / Norme(s)
2014/34/EU ATEX-Richtlinie 2014/34/EU <i>ATEX Directive</i> 2014/34/UE <i>Directive ATEX</i>	EN 60079-0:2012 + A11:2013 EN 60079-1:2014 EN 60079-31:2014
Kennzeichnung, marking, marquage:	II 2 G Ex db IIB+H ₂ T4/ T6 Gb 0158 II 2 D Ex tb IIIC T135 °C/ T85 °C Db
EU-Baumusterprüfbescheinigung: <i>EU Type Examination Certificate:</i> <i>Attestation d'examen UE de type:</i>	Baseefa 02 ATEX 0222 X (SGS Fimko Oy, Särkiniementie 3, P.O. Box 30, FI-00211 Helsinki, Finland)
Produktnormen nach Niederspannungsrichtlinie: <i>Product standards according to Low Voltage Directive:</i> <i>Normes des produit pour la Directive Basse Tension:</i>	EN 60598-1:2015 + A1:2018 EN 62471:2008
2014/30/EU EMV-Richtlinie 2014/30/EU <i>EMC Directive</i> 2014/30/UE <i>Directive CEM</i>	EN 50130-4:2011 + A1:2014 EN 61000-3-2:2014 EN 61000-3-3:2013 EN 61000-6-4:2007 + A1:2011
2011/65/EU RoHS-Richtlinie 2011/65/EU <i>RoHS Directive</i> 2011/65/UE <i>Directive RoHS</i>	EN IEC 63000:2018

Waldenburg, 2021-03-22

Ort und Datum
Place and date
Lieu et date

i.V.

Dr. C. Chevalier
Vice President BU Lighting & Signalling
Vice-Président BU Eclairage & Appareils de signalisation

i.V.

J. Freimüller
Vice President global Quality Management
Vice-Président globale Gestion de Qualité