

4 THE I.S. 1 SYSTEM

4.1 Overall system

Remote I/O I.S. 1 system

- Modular remote I/O System for 35 mm DIN rail mounting
- Installation in Zone 1 or Zone 2 / Division 2 or in safe areas
- Intrinsically safe EEx ia IIC inputs and outputs
- Fieldbus communication: Modbus, Profibus DP, etc.
- Hot swap for all modules
- Redundant internal system bus fitted as standard
- Redundancy for the fieldbus and CPU & Power Module
- Optional ServiceBus for parameterization, fault diagnostics and HART communication
- HART input and output modules for transmitters and positioners
- Very easy engineering by using PowerBus and BusRail
- Field enclosures in many versions, engineered to choice

Example configuration

Fig. 4-1 shows a fully fitted I.S. 1 system.

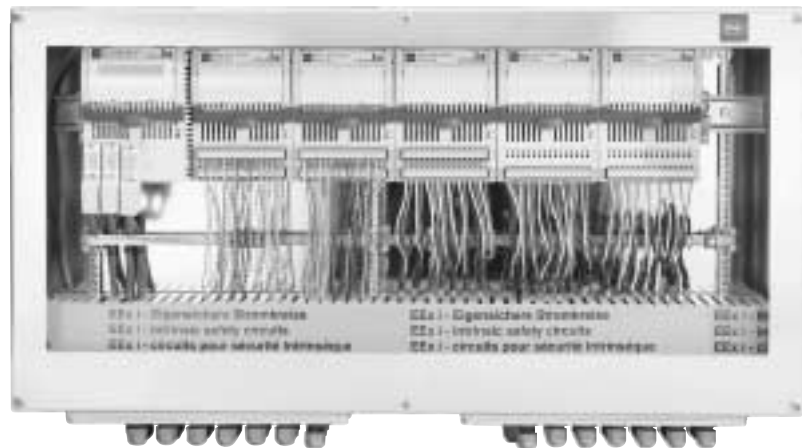

Fig. 4-1 Example configuration of a field station installed in an enclosure

4.1.1 Schematic configuration of an automation system

The I.S. 1 system is a Remote I/O system for the input and output of process signals. It is integrated into an automation system in the form of decentralized field stations.

Fig. 4-2 shows an overview of the schematic configuration of an automation system (parameter and control level, Remote-I/O level, field device level).

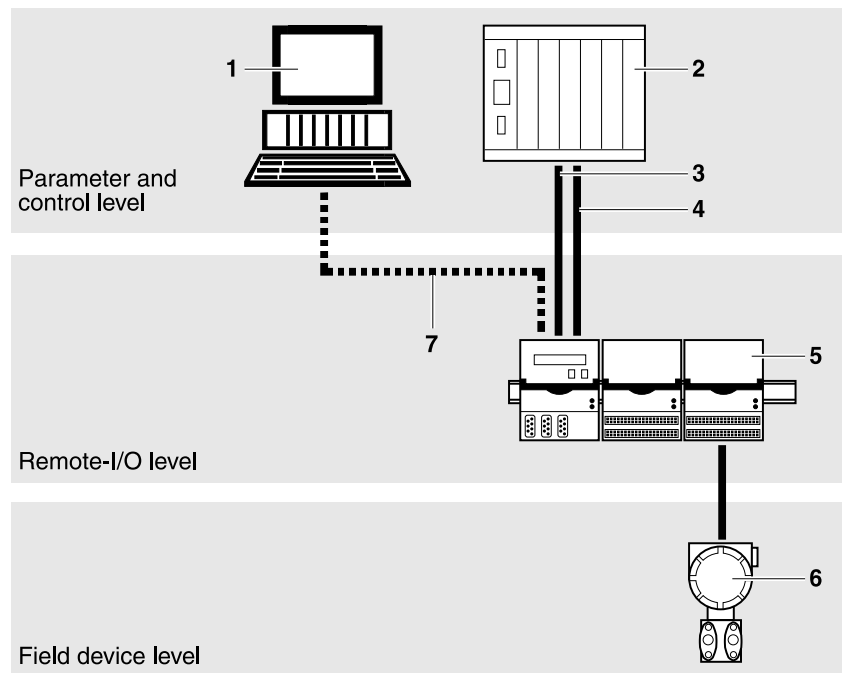

Fig. 4-2 Schematic configuration of an automation system

- 1 PC, optional (for setting parameters)
- 2 Automation device
- 3 Fieldbus
- 4 Redundant fieldbus
- 5 Remote I/O field station (I.S. 1 system)
- 6 Field devices
- 7 ServiceBus (optional)

4.1.2 Advantages

Simple power supply concept

I.S. 1 is extremely simple to use: a CPU & Power Module and, according to requirements, several input/output modules are snapped on to the Bus-Rail (35 mm DIN rail). The unique PowerBus power supply concept, developed especially for use in hazardous areas, makes system planning as simple as for normal industrial I/O systems.

Installation in Zone 1, Zone 2 or safe areas

I.S. 1 is particularly flexible: It can be used for small and large signal quantities with the possibility of installing field stations in Zone 1 or Zone 2 / Division 2. Installation in control rooms is also possible. An intrinsically safe fieldbus using copper-wire or fibre-optic technology connects field stations in Zone 1 with the automation devices.

Up to 16 inputs per module

I.S. 1 is extremely economical: modules with 8 or 16 inputs lower the price per signal. The optional ServiceBus in connection with the "I.S. Wizard" software cuts down the time for commissioning and trouble shooting.

HART suitable

In addition to conventional sensors and actuators, the I.S. 1 system can also be fitted with HART transmitters and control valves. Special I/O modules are available for this purpose. Communication with the HART field devices is carried out either via the ServiceBus or via the fieldbus, where the necessary functionalities are supported.

OPERATING INSTRUCTIONS FOR THE I.S. 1 SYSTEM

4.2 Functionality of the I.S. 1 system

4.2.1 Functionality regarding the fieldbus interfaces and protocols

Protocol	Function
Profibus DP	<ul style="list-style-type: none">• Cyclical data exchange for the inputs and outputs between the automation device and the I.S. 1 field station• Download of parameters in the I.S. 1 field station when the fieldbus powers up• Cyclical upload of diagnostic information from the I.S. 1 field station
Modbus RTU	<ul style="list-style-type: none">• Cyclical data transmission for the inputs and outputs between the automation device and the I.S. 1 field station• Transmission of diagnostic information from the I.S. 1 field station
ServiceBus (R. STAHL specific)	<ul style="list-style-type: none">• Downloading of firmware• Downloading of parameters• Reading the inputs• Setting the outputs• Reading the diagnostic information• Transmission of HART commands between HART field devices and PC software

Tab. 4-1 Functionality of the I.S. 1 system regarding the fieldbus interfaces and the protocols

4.2.2 Functionality regarding various input and output signals

Signal type	Application	Type of signal
Analog input signal	2-, 3- and 4-wire transmitter 2- and 4-wire transmitter HART	0..20 mA, 4 - 20 mA 4..20 mA + FSK HART
Temperature input signal	Pt 100, Ni 100, etc. Potentiometer Thermocouples J, K, etc.	mV range V range mV range
Digital input signal	Contacts, NAMUR proximity switches	< 1.2 mA > 2.1 mA
Analog output signal	I/P-transformer, positioner, indicator HART positioner	0..20 mA, 4 - 20 mA 4..20 mA + FSK HART
Digital output signal	Solenoid valves Indicating lamp, Ex i power supply	e.g. 12 V/40 mA

Tab. 4-2 Functionality of the I.S. 1 system regarding various input and output signals

4.2.3 Tabular overview of the extended system functionalities

Function	Control option using
Monitoring of inputs and outputs for open circuits and short circuits	<ul style="list-style-type: none"> • LED red ERR on I/O module • Fieldbus • ServiceBus
Reloading parameters when replacing an I/O module	<ul style="list-style-type: none"> • CPU & Power Module
Reloading parameters when replacing the CPU & Power Module	<ul style="list-style-type: none"> • Profibus DP
Automatic module error detection	<ul style="list-style-type: none"> • LED red ERR on module • Fieldbus • ServiceBus
Simulation of connected field devices	<ul style="list-style-type: none"> • Software "I.S. Wizard"
Simulation of connected automation devices	<ul style="list-style-type: none"> • Software "I.S. Wizard"
Network capability	<ul style="list-style-type: none"> • Software "I.S. Wizard"

Tab. 4-3 Overview of the extended functionality of the I.S. 1 system

4.3 Network structure

4.3.1 Internal bus

The internal bus provides data exchange between the CPU & Power Module and the I/O modules. It is a component of the BusRail.

The I/O modules are addressed on the internal bus by means of the slot on the BusRail, so that an address setting is not necessary.

The internal bus in the BusRail is designed to be **redundant** in all modules, so that even in the event of a fault the communication between modules is guaranteed.

Redundancy in internal bus

Fig. 4-3 shows how the redundancy of the internal bus is achieved via the BusRail.

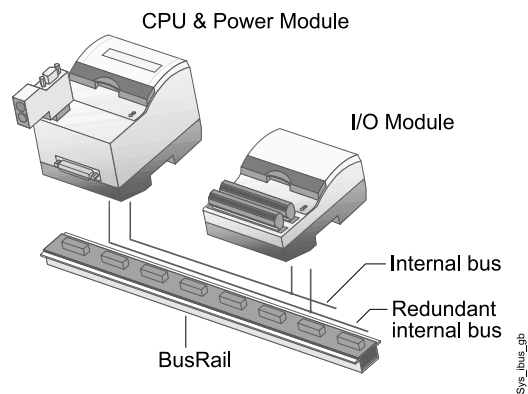

Fig. 4-3 Implementation of redundancy of internal bus via the BusRail

Two independent circuits are available for the internal bus. As the I/O modules are not connected in series, data transmission is guaranteed even if an I/O module is defective.

OPERATING INSTRUCTIONS FOR THE I.S. 1 SYSTEM

4.3.2 Fieldbus – general information

The fieldbus is the connection between CPU & Power Module and the automation system (PLC, DCS, PC). Input and output data between the field stations and the automation equipment are exchanged over the fieldbus.

Fieldbuses that can be connected:

- Profibus DP, up to 1.5 MBit / s
- Modbus RTU, up to 38.4 kBit / s
- Other fieldbuses in preparation

Network structure with Profibus DP

Fig. 4-4 shows an option for structuring the information network when using the Profibus protocol.

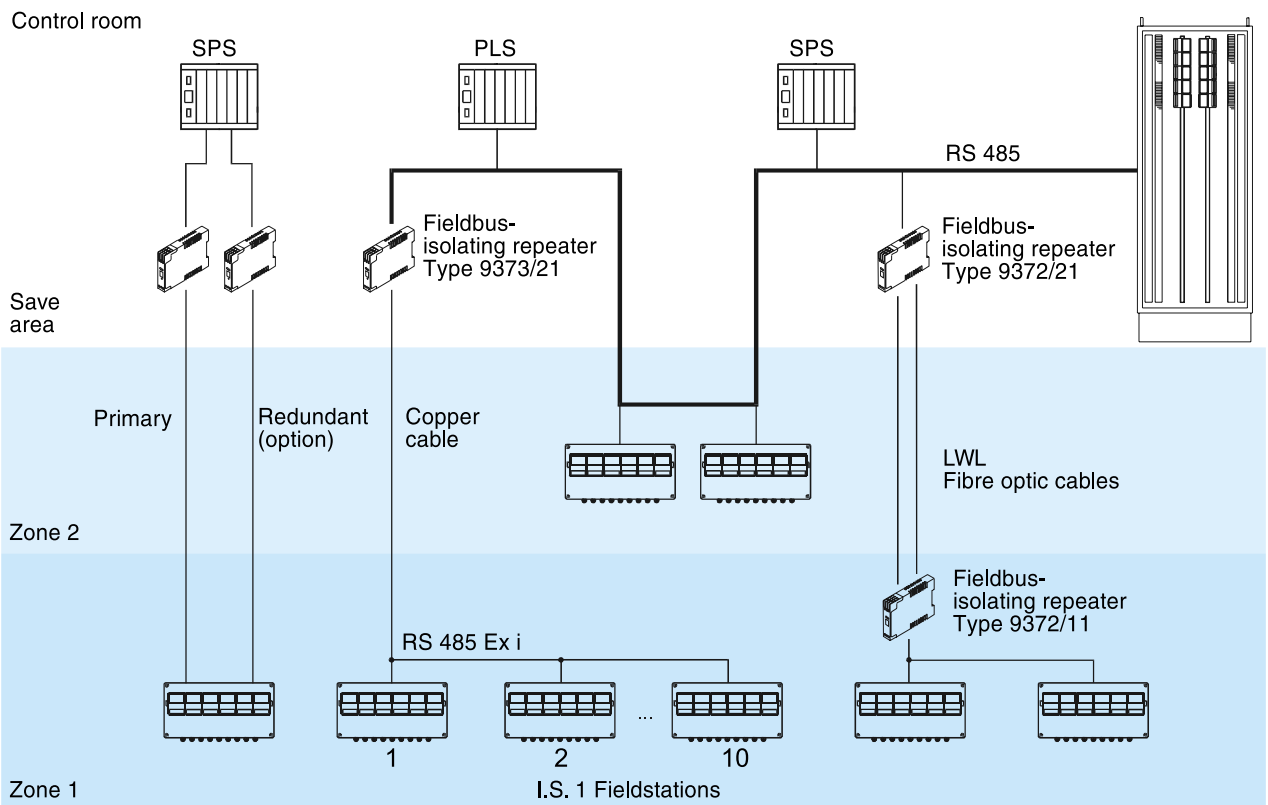

Fig. 4-4 Schematic configuration of an automation system in various Zones

Functionality of the fieldbuses

Depending on the functionality of the fieldbus, the following functions are supported:

- Configuration of the I.S. 1 field station or read back the configuration
- Load the modules with parameters
- Read/write input and output data
- Read the alarms and diagnostic data of a field station

4.3.3 Fieldbus - intrinsically safe for Zone 1

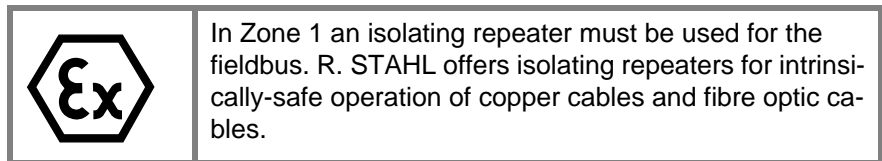

Isolating repeater

The fieldbus is operated intrinsically safe for field stations in Zone 1. The fieldbus isolating repeater provides the intrinsic safety of a fieldbus segment. Several fieldbus isolating repeaters can be connected as repeaters to a fieldbus that is not intrinsically safe.

The following designs can be used, according to choice:

- For copper cables:
Fieldbus isolating repeater RS 485 (up to 200 m at 1.5 MBit / s)
- For fibre optic cables:
Fieldbus isolating repeater (up to 2000 m at 1.5 MBit / s)

Number of field stations

A maximum of 10 field stations can be connected to an intrinsically safe RS 485 segment (Zone 1).

A maximum of 32 devices (PLC, isolating repeaters, field stations) can be connected to an RS 485 fieldbus which is not intrinsically safe (Zone 2).

The number of field stations that can be addressed depends on the fieldbus protocol (e.g. up to 126 with Profibus DP).

4.3.4 ServiceBus

The CPU & Power Module has, in addition to the fieldbus connection, an interface for the ServiceBus.

The ServiceBus is connected to a PC.

Network structure of the ServiceBus

Up to 18 field stations can be connected together via the ServiceBus. The network is configured so that, even if a field station fails, the data transmission from and to the other field stations is guaranteed.

When used in Zone 1, the data are transmitted to the safe area through a common cable. The fieldbus isolating repeater 9373, located in the safe area, is used as the interface between RS 485 Ex i and RS 232 signals.

In addition, the ServiceBus can also be used to transmit HART commands from and to HART field devices. This provides the option of parametrizing HART field devices, requesting diagnostic data and administrating the corresponding database from a central location (see section "HART").

Network structure for the ServiceBus

Fig. 4-5 shows an option for structuring the information network when using the ServiceBus.

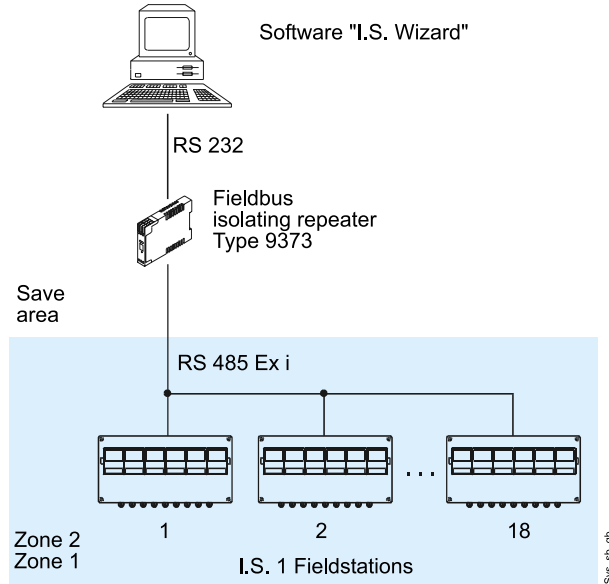

Fig. 4-5 Configuration of the information network when using the ServiceBus

4.3.5 PC software

The software package "I.S. Wizard" offers the user many options for rapidly and simply operating and maintaining I.S. 1 systems and field stations.

Functions with ServiceBus

The ServiceBus can be used to:

- Configure field stations
- Read back configurations
- Parameterize the CPU & Power Module and I/O modules
- Read inputs, write outputs
- Read and interpret diagnostic data for three levels: Field stations, modules, signals
- Read information (e.g. module type, module revision)
- Simulate inputs and outputs

Screenshot of the software "I.S. Wizard"

Fig. 4-6 shows a screenshot of the software "I.S. Wizard" By clicking on the module icon, each individual module can be controlled.

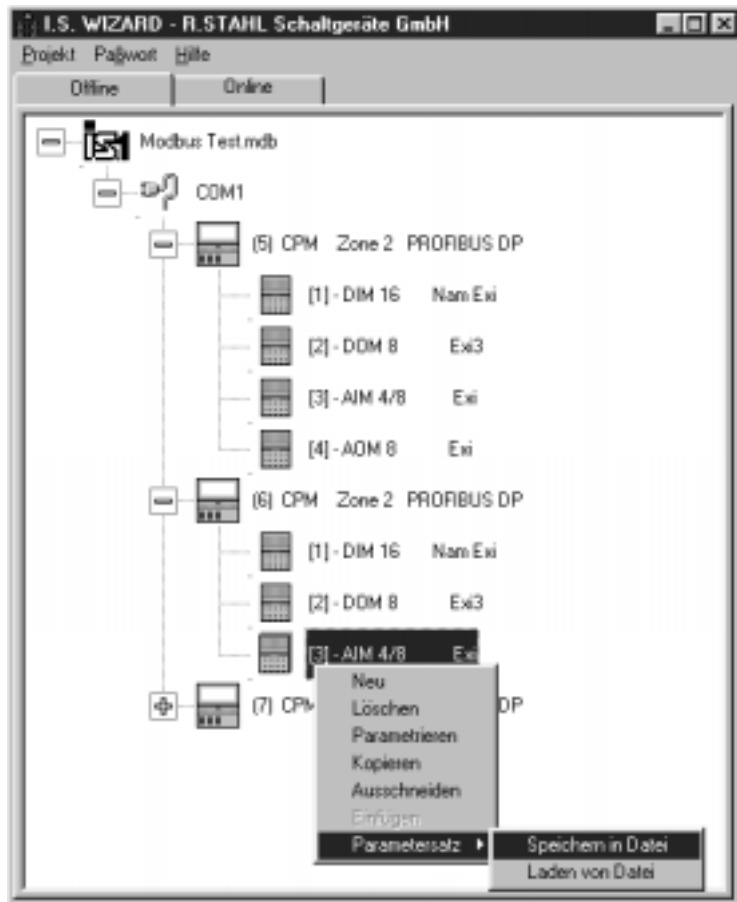

Fig. 4-6 Representation of each individual module using the software I.S. Wizard

OPERATING INSTRUCTIONS FOR THE I.S. 1 SYSTEM

Additional functions of the software "I.S. Wizard"

A complete test of a field station can be implemented without a fieldbus. "I.S. Wizard" can also be operated on the ServiceBus simultaneously with the fieldbus (read access).

"I.S. Wizard" permits operation of I.S. 1 field stations together with VOS 200 field stations on a ServiceBus so that even existing VOS 200 systems can be extended with I.S. 1 stations.

Open interfaces with OPC (OLE for process control) and ActiveX permit the integration of "I.S. Wizard" in control systems or MS Office applications.

4.3.6 HART protocol

Suitable HART modules are available for the connection of HART transmitters and positioners.

The process value is analog processed with the 4 - 20 mA signal. The I.S. 1 field station behaves transparently for the exchange of HART command between an engineering station and the HART field devices.

The transmission of commands occurs either via:

- The ServiceBus or
- The fieldbus (in preparation, e.g. with Profibus DP V1)

Software packages can be operated on the ServiceBus to administrate the databases of all HART field devices at a central location.

ServiceBus compatible software, e.g.:

- Cornerstone by ASTEC
- AMS by Fisher Rosemount
- PDM by Siemens (in preparation)



R. STAHL supplies complete HART management systems.

Network structure for HART

Fig. 4-7 shows an option for structuring the information network when using the HART protocol.

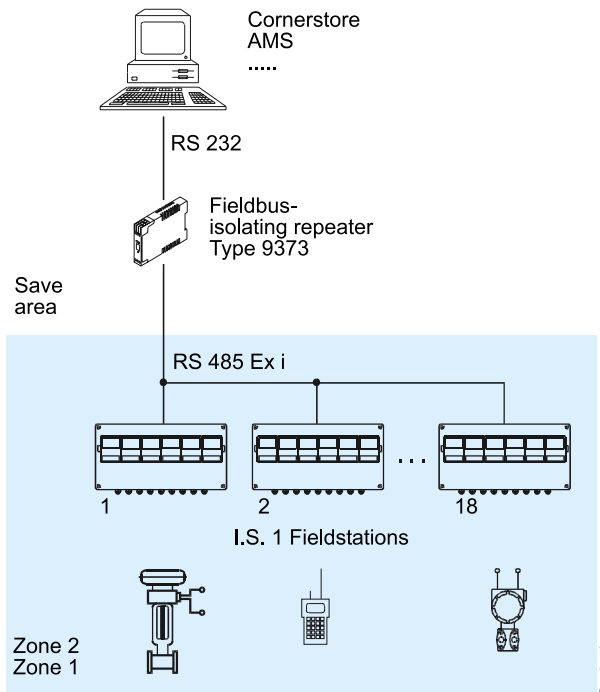

Fig. 4-7 Configuration of the information network when using the HART protocol

4.4 Configuration

4.4.1 Mechanical configuration of the I.S. 1 system

The I.S. 1 system provides a modern, cost-effective and flexible remote I/O system with intrinsically safe inputs and outputs, suitable for direct installation in hazardous areas. The uniform system concept permits installation in Zone 1, in Zone 2 / Division 2 and in safe areas. Inputs and outputs are optimized for the sensors and actuators used in process technology. The integration of different fieldbuses permits digital communication with many automation systems (PLC, PCS, PC).

I.S. 1 consists of three components:

- BusRail for the internal bus and for the power supply of the I/O modules (PowerBus)
- CPU & Power Module for fieldbus communication and power supply
- I/O modules for the inputs and outputs of the process signals

An extensive range of field enclosures permits adaptation to the mechanical requirements of an application.

Mechanical configuration

Fig. 4-8 shows how individual components can be connected together.

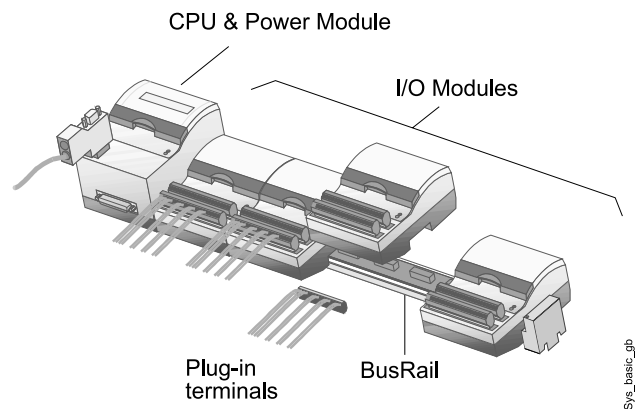
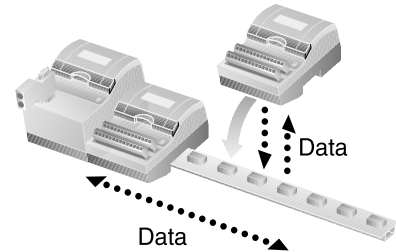

Fig. 4-8 Mechanical configuration of the I.S. 1 system

4.4.2 Functional configuration of the I.S. 1 system

The system is composed of a CPU & Power Module for control and individual I/O modules. The power supply and internal data transportation ("Data" arrow) is provided through the BusRail.



4.4.3 Redundancy

The high system availability that is required for applications in process industry is guaranteed through a proven redundancy concept.

Various redundancy stages permit adaptation to the availability requirements of the user:

- Fieldbus cable redundancy
- CPU & Power Module redundancy

The internal bus of an I.S. 1 field station is always redundantly configured.

Fieldbus and module redundancy

Fig. 4-9 shows two redundancy stages of the system. On the left, a CPU & Power Module with fieldbus connection and redundant fieldbus connection is shown. On the right, the redundancy is implemented with two CPU & Power Modules.

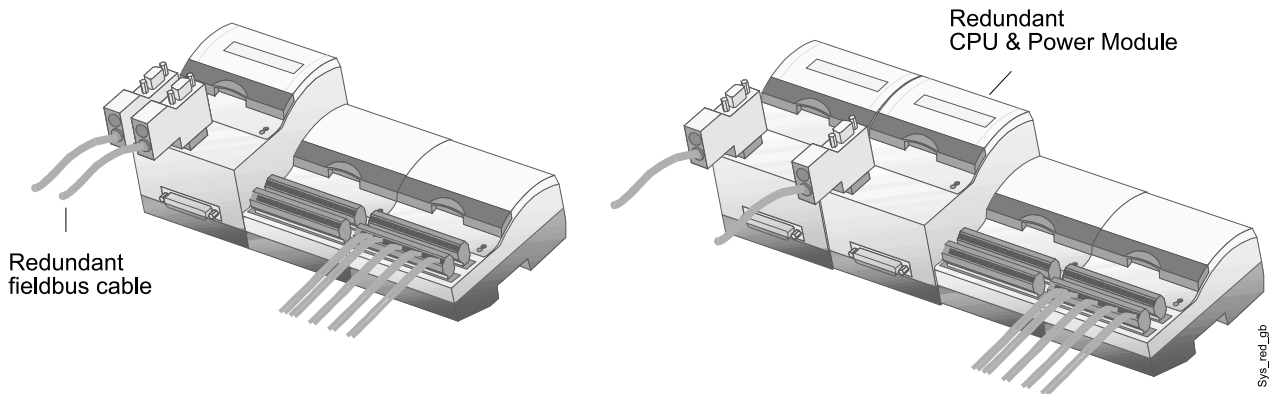

Fig. 4-9 Redundancy of the fieldbus connection (left) and redundancy of the CPU & Power Module (right)

4.4.4 Hot swap

Hot swap indicates the exchangeability of the modules during operation without requiring a new start-up.

All modules in the I.S. 1 system can be replaced at any time during station operation. This also applies for the Zone 1 CPU & Power Modules.

The I/O modules are fitted with plug-in terminals for connection to the field cable so that the field wiring does not have to be disconnected when replacing a module.

Automatic restart

When an I/O module is replaced, the CPU & Power Module automatically:

- Checks the type and version of the new I/O module
- Loads the current parameter set into the new I/O module
- Starts the new module

Replacement of modules when controlled by Profibus DP

When Profibus DP is used, the CPU & Power Module can also be replaced without further measures:

- The I/O module parameters are loaded via the Profibus DP into the new CPU & Power Module
- Address setting is not required (addresses are stored in the I/O modules)

Fig. 4-10 shows how the modules can be removed during operation (Hot swap).

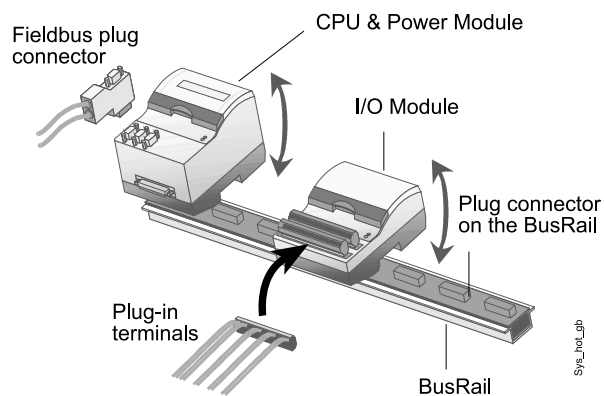

Fig. 4-10 Hot swap of CPU & Power Modules and I/O modules.

4.4.5 Configuration of a field station

A field station of the I.S. 1 system forms a functional unit that is configured and parameterized according to its tasks.

Fig. 4-11 shows a field station with open enclosure. In this example, one CPU & Power Module controls five I/O modules.

Example configuration of a field station



Fig. 4-11 Typical configuration of the I.S. 1 system

4.4.6 Configuration of a field station / distribution of a BusRail on several rails

Limitations based on insertion zone



The configuration of a field station is zone-specific limited: In Zone 1, a maximum of 8 I/O modules can be operated per field station. In Zone 2 and in safe areas a maximum of 16 I/O modules can be operated per field station.
For further information regarding zone-dependent system configuration, see Chapter 5.1.3.

The I/O modules have 4, 8 or 16 channels and can be plugged into any position on the BusRail.

A BusRail can be mechanically distributed over several rail segments. Individual segments are connected by cable. The number of I/O signals per field station can be limited by the fieldbus used.

Fig. 4-12 shows the distribution of a Bus Rail over two segments.

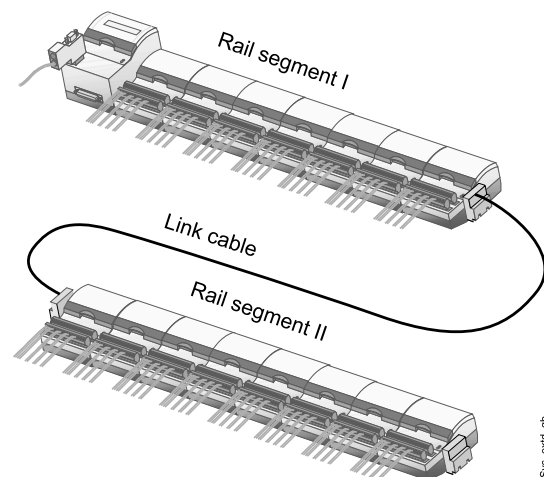

Fig. 4-12 Possible implementation of a field station configuration

4.5 Overview of components

The I.S. 1 system is divided into three component groups:

- CPU & Power Module
 - for Zone 1
 - for Zone 2
- I/O modules
 - for analog signals
 - for digital signals
- BusRail
 - in various lengths
 - with various terminations

Depending on the installation area and application, physically different components must be used.

4.5.1 CPU & Power Module

Type	Description	Abbreviation	Power supply	Application
9440/12-01-11	CPU & Power Module for Zone 1	CPM1	24 V DC	<ul style="list-style-type: none"> • Profibus DP • Modbus
9440/15-01-11	CPU & Power Module for Zone 2	CPM2	24 V DC	<ul style="list-style-type: none"> • Profibus DP • Modbus

Tab. 4-4 Overview of CPU & Power Modules

Further information on the CPU & Power Module for Zone 1, Type 9440/12

	See Chapter 4.6.1 (Description of components), Chapter 7.4 (Connection allocation) and Chapter 13.3.1 (Technical data).
-------------------------------------------------------------------------------------	-------------------------------------------------------------------------------------------------------------------------

Further information on the CPU & Power Module for Zone 2, Type 9440/15

	See Chapter 4.6.2 (Description of components), Chapter 7.5 (Connection allocation) and Chapter 13.3.2 (Technical data).
-------------------------------------------------------------------------------------	-------------------------------------------------------------------------------------------------------------------------

OPERATING INSTRUCTIONS FOR THE I.S. 1 SYSTEM

4.5.2 I/O modules

	<p>Modules 9471 and 9477 do not have explosion protection.</p> <p>Except for modules 9471 and 9477, the following I/O modules are suited for use in Zones 1 and 2.</p> <p>The inputs or outputs of the modules with explosion protection are intrinsically safe.</p>
-----------------------------------------------------------------------------------	----------------------------------------------------------------------------------------------------------------------------------------------------------------------------------------------------------------------------------------------------------------------

I/O modules for analog signals

Type	Description	Abbreviation	Channels	Typical application
9460/12-08-11	Analog input module 0/4-20 mA	AIM	8/4	<ul style="list-style-type: none"> • 2-wire transmitter • Active 0/4-20 mA signal • 4-wire transmitter
9461/12-08-11	Analog input module 4-20 mA HART	AIMH	8	<ul style="list-style-type: none"> • 2-wire transmitter with HART communication
9461/12-08-21	Analog input module 4-20 mA HART	AIMH	8	<ul style="list-style-type: none"> • 2-wire and 4-wire transmitters with HART communication
9480/12-08-11	Temperature Input Module R	TIMR	8	<ul style="list-style-type: none"> • Resistance thermometer (Pt 100, Pt 1000, etc.) • Remote potentiometer
9481/12-08-11	Temperature Input Module mV	TIMmV	8	<ul style="list-style-type: none"> • Thermocouples • mV sensor
9465/12-08-11	Analog Output Module 0/4-20 mA	AOM	8	<ul style="list-style-type: none"> • Positioner • I/P converter • Indicator
9466/12-08-11	Analog Output Module 0/4-20 mA HART	AOMH	8	<ul style="list-style-type: none"> • Positioner with HART communication

Tab. 4-5 Overview of all I/O modules for analog signals

I/O modules for digital signals

Type	Description	Abbreviation	Channels / Ex-protection	Typical application
9470/22-16-11	Digital Input Module NAMUR	DIM	16	<ul style="list-style-type: none"> • NAMUR proximity switch • Contact • Optocoupler
9471/10-16-11	Digital Input Module 24 V	DIM24V	16 without Ex-protection	<ul style="list-style-type: none"> • Contacts
9475/12-04-11	Digital Output Module 17 V; 11 V / 40 mA	DOM4	4	<ul style="list-style-type: none"> • Ex i solenoid valve • Ex i indicating lamp
9475/12-04-21	Digital Output Module 23 V; 12.5 V / 40 mA	DOM4	4	<ul style="list-style-type: none"> • Ex i solenoid valve • Ex i indicating lamp
9475/12-04-31	Digital Output Module 23 V; 10 V / 40 mA	DOM4	4	<ul style="list-style-type: none"> • Ex i solenoid valve • Ex i indicating lamp
9475/12-08-41	Digital Output Module 9.5 V; 4.5 V / 30 mA	DOM8	8	<ul style="list-style-type: none"> • Ex i solenoid valve • Ex i indicating lamp
9475/12-08-51	Digital Output Module 17 V; 13 V / 26 mA	DOM8	8	<ul style="list-style-type: none"> • Ex i solenoid valve • Ex i indicating lamp
9475/12-08-61	Digital Output Module 23 V; 17.5 V / 20 mA	DOM8	8	<ul style="list-style-type: none"> • Ex i solenoid valve • Ex i indicating lamp
9477/10-08-12	Digital Output Module Relay 1 contact nor- mally open	DOMR	8 without Ex-protection	<ul style="list-style-type: none"> • Solenoid valves • Signal output

Tab. 4-6 Overview of all I/O modules for digital signals

Further information regarding the modules

	<p>See Chapter 4.6 (Description of components), Chapter 7.6 (Connection allocation) and Chapter 13.3 (Technical data).</p>
-------------------------------------------------------------------------------------	----------------------------------------------------------------------------------------------------------------------------

OPERATING INSTRUCTIONS FOR THE I.S. 1 SYSTEM

4.5.3 BusRail and terminations

	BusRail and termination are determined independent of the type for use in Zones 1 and 2.
-----------------------------------------------------------------------------------	------------------------------------------------------------------------------------------

BusRail / terminations

Type	Description	Abbreviation	Typical application
9494/S1-M4	BusRail 4 modules	BRM4	• BusRail for 4 modules
9494/S1-B2	BusRail 2 modules, begin	BRB2	• BusRail for 2 modules, begin
9494/S1-E2	BusRail 2 modules, end	BRE2	• BusRail for 2 modules, end
9494/A1-B0	Termination BusRail, begin	BRAB	• Termination for BusRail, begin
9494/A1-E0	Termination BusRail, end	BRAE	• Termination for BusRail, end
9494/A2-B0	Termination BusRail, begin Sub-D	BRAB Sub-D	• Termination BusRail, begin with Sub-D socket
9494/A2-E0	Termination BusRail, end Sub-D	BRAE Sub-D	• Termination BusRail, end with Sub-D socket
9491/Z0-VB	Connection cable BusRail 110 cm	BR cab	• Connection between 2 BusRail segments

Tab. 4-7 Overview of all BusRail types and terminations

Further information regarding BusRails

	See Chapter 4.6.14 (Description of the BusRail) and Chapter 13.3.15 (Technical data).
-------------------------------------------------------------------------------------	---------------------------------------------------------------------------------------

Further information regarding terminations

	See Chapter 4.6.15 (Description of terminations), Chapter 7.8 (Connection allocation) and Chapter 13.4.7 (Dimensions).
-------------------------------------------------------------------------------------	------------------------------------------------------------------------------------------------------------------------

4.6 Description of the components

The working method of the I.S. 1 system is based on the functions of the components: CPU & Power Module, I/O modules and the BusRail with terminations. The tasks of the components are summarized below in three groups.

Control	<p>CPU & Power Modules</p> <ul style="list-style-type: none"> • Control the data exchange from the PLC or PCS with the I/O modules • Stores the values of the input/output signals in a memory as a process image • Control the data exchange with the connected automation devices via the fieldbus • Transfer output signals from the fieldbus to the output module • Transfer input signals from the input module to the fieldbus • Contain a power supply and supply the I/O modules and the field circuits with electrical power
Signal processing of field devices	<p>I/O modules</p> <ul style="list-style-type: none"> • Create the interfaces to the field devices (sensors and actuators) • Condition the output signals. The output signal is then output • Measure the input signals and condition them. They are then transmitted to the CPU & Power Module • Monitor all inputs and outputs for open circuits and short circuits • Are parameterized according to their tasks
Data transport and fixing	<p>BusRail with terminations</p> <ul style="list-style-type: none"> • Serves as power, data and address circuit for the internal bus • Mechanically secures the modules • Protects the electrical connections against bangs, shocks and moisture

4.6.1 CPU & Power Module for Zone 1

Remote I/O system
CPU & Power Module for Zone 1
Type 9440/12

- Fieldbus interface / gateway and power supply in a single module
- Integrated power supply for up to 8 I/O modules
- Installation in Zone 1
- Power supply 24 V DC, connection EEx e
- Galvanic isolation between fieldbus, ServiceBus, power supply and internal data bus
- Intrinsically safe fieldbus and ServiceBus
- Profibus DP, up to 1.5 MBit / s
- Modbus RTU, up to 38.4 kBit / s
- Additional ServiceBus interface for commissioning, fault diagnostics and HART communication
- LCD indicator for local display of diagnostic data, input and output values
- Status LEDs for RUN and ERROR
- Fieldbus cable connection with standardized Sub-D 9 connectors
- Module can be hot swapped in Zone 1 while powered up
- Certificates for Europe



Operation

The CPU & Power Module contains a power supply unit for its own power supply, as well as for the supply to the I/O modules and the field circuits. The power supply for the I/O modules is implemented via the BusRail. When using a redundant CPU & Power Module, the power supply to the I/O modules is internally decoupled with diodes. The power supply unit is fitted with undervoltage monitoring.

The CPU fulfills the function of a gateway between the internal bus of an I.S. 1 field station and the fieldbus which connects the field station with the automation system. The gateway is built up as a dual processor system. The I/O processor controls the data exchange with the I/O modules and, when plugged-in, with the redundant CPU & Power Module. The communication processor controls the data exchange on the fieldbus and on the redundant fieldbus and on the ServiceBus.

Operation (continued)

The communication with the I/O modules is implemented via the address and data lines on the BusRail. The interface of the CPU & Power Module with the internal data bus on the BusRail is designed with redundancy. The electronics are in flameproof enclosures and connected with plug connectors EEx d and EEx i to the base. The power supply connection is EEx e; the interfaces for fieldbus and ServiceBus are intrinsically safe EEx i.

Further information regarding this module

	See Chapter 7.4.1 (Connection diagram) and Chapter 13.3.1 (Technical data).
-----------------------------------------------------------------------------------	-----------------------------------------------------------------------------

4.6.2 CPU & Power Module for Zone 2

Remote I/O system
CPU & Power Module for Zone 2
Type 9440/15

- Fieldbus interface / gateway and power supply in a single module
- Integrated power supply for 16 I/O modules
- Installation in Zone 2 / Division 2 or in safe areas
- Power supply 24 V DC
- Galvanic isolation between fieldbus, ServiceBus, power supply and internal data bus
- Profibus DP, up to 1.5 MBit / s
- Modbus RTU, up to 38.4 kBit / s
- Additional ServiceBus interface for commissioning, fault diagnostics and HART communication
- LCD indicator for local display of diagnostic data, input and output values
- Status LEDs for RUN and ERROR
- Field cable connection with standardized Sub-D 9 connectors
- Certificates for Europe



Operation

The CPU & Power Module contains a power supply unit for its own power supply, as well as for the supply to the I/O modules and the field circuits. The power supply for the I/O modules is implemented via the BusRail. When using a redundant CPU & Power Module, the power supply to the I/O modules is internally decoupled with diodes. The power supply unit is fitted with undervoltage monitoring.

The CPU fulfills the function of a gateway between the internal bus of an I.S. 1 field station and the fieldbus which connects the field station with the automation system. The gateway is built up as a dual processor system. The I/O processor controls the data exchange with the I/O modules and, when plugged-in, with the redundant CPU & Power Module. The communication processor controls the data exchange on the fieldbus and on the redundant fieldbus and on the ServiceBus.

The communication with the I/O modules is implemented via the address and data lines on the BusRail. The interface of the CPU & Power Module with the internal data bus on the BusRail is designed with redundancy.

Further information regarding this module



See Chapter 7.5 (Connection allocation) and Chapter 13.3.2 (Technical data).

4.6.3 Analog Input Module

Remote I/O system
Analog Input Module
Type 9460

- For 2-wire, 3-wire and 4-wire transmitters and for active mA sources
- Up to 8 channels
- Intrinsically safe EEx ia IIC inputs
- Installation in Zone 1 or Zone 2 / Division 2
- Signal 0 .. 20 mA or 4 .. 20 mA
- Galvanic isolation between inputs and system
- Open-circuit and short-circuit monitoring for each field circuit
- Functions can be parameterized
- 12/15 bit resolution
- Conversion time from 20 ms
- Status LEDs for RUN and ERROR
- Connection of the field cables with plug-in terminals
- Module can be hot swapped while powered up
- Certificates for Europe



Operation

The 0 .. 20 mA or 4 .. 20 mA input signals are detected while multiplexed and an A/D conversion is executed. Each input is individually monitored for open- and short-circuits.

Up to 8 transmitters, 2-wire or 3-wire, can be supplied with power by the module. The power supply is short-circuit proof and intrinsically safe.

Power supplies for 4-wire transmitters are provided by an external voltage source.

The interface of the Analog Input Module with the internal data bus of the BusRail is designed with redundancy.

Further information regarding this module

	<p>See Chapter 7.6.3 (Connection allocation) and Chapter 13.3.3 (Technical data).</p>
-------------------------------------------------------------------------------------	---------------------------------------------------------------------------------------

4.6.4 Analog Input Module HART/-1

Remote I/O system
Analog Input Module HART
Type 9461/1.-08-1.

- For 2-wire transmitter
- 8 channels
- Intrinsically safe EEx ia IIC inputs
- Installation in Zone 1 or Zone 2 / Division 2
- Galvanic isolation between inputs and system
- Open-circuit and short-circuit monitoring for each field circuit
- Functions can be parameterized
- HART communication optional
- 12 bit resolution
- Conversion time from 20 ms
- Status LEDs for RUN and ERROR
- Connection of the field cables with plug-in terminals
- Module can be hot swapped while powered up
- Certificates for Europe



Operation

The 0 .. 20 mA or 4 .. 20 mA input signals are detected while multiplexed and an A/D conversion is executed. Each input is individually monitored for open- and short-circuits.

Each transmitter is supplied with power from the module. The power supply is short-circuit proof and intrinsically safe.

The interface of the Analog Input Module with the internal data bus of the BusRail is designed with redundancy.

The integrated HART multiplexer permits bi-directional HART communication. The module is transparent for the HART commands. The HART information is transferred from the CPU & Power Module via the ServiceBus: alternatively via the fieldbus if this service is supported.

Analog transmitters (non-HART) can also be operated.

Further information regarding this module



See Chapter 7.6.4 (Connection allocation) and Chapter 13.3.4 (Technical data).

4.6.5 Analog Input Module HART/-2

Remote I/O system

Analog Input Module HART

Type 9461/1.-08-2.

- For 2-wire and 4-wire transmitters
- 8 channels
- Intrinsically safe EEx ia IIC inputs
- Installation in Zone 1 or Zone 2 / Division 2
- Galvanic isolation between inputs and system
- Open-circuit and short-circuit monitoring for each field circuit
- Functions can be parameterized
- HART communication optional
- 12 bit resolution
- Conversion time from 20 ms
- Status LEDs for RUN and ERROR
- Connection of the field cables with plug-in terminals
- Module can be hot swapped while powered up
- Certificates for Europe



Operation

The 0 .. 20 mA or 4 .. 20 mA input signals are detected while multiplexed and an A/D conversion is executed. Each input is individually monitored for open- and short-circuits.

Channels 0 – 3 are suitable for 2-wire transmitters. These transmitters are supplied with power from the module. The power supply is short-circuit proof and intrinsically safe.

Channels 4 – 7 are suitable for 4-wire transmitters. The power supply is provided from an external voltage source.

The interface of the Analog Input Module with the internal data bus of the BusRail is designed with redundancy.

The integrated HART multiplexer permits bi-directional HART communication. The module is transparent for the HART commands. The HART information is transferred from the CPU & Power Module via the ServiceBus: alternatively via the fieldbus if this service is supported.

Analog transmitters (non-HART) can also be operated.

Further information regarding this module

	<p>See Chapter 7.6.5 (Connection allocation) and Chapter 13.3.5 (Technical data).</p>
-------------------------------------------------------------------------------------	---------------------------------------------------------------------------------------

4.6.6 Temperature Input Module R

Remote I/O system

Temperature Input Module R

Type 9480

- For all common resistance thermometers (such as PT 100, NI 100) as well as for remote potentiometers up to 10 kOhm
- Termination system 2-, 3- or 4-wire
- 8 channels
- Intrinsically safe EEx ia IIC inputs
- Installation in Zone 1 or Zone 2 / Division 2
- Galvanic isolation between inputs and system
- Open-circuit and short-circuit monitoring for each field circuit
- Functions can be parameterized
- Resolution 0.1 °C
- Conversion time 720 ms for 8 channels
- Status LEDs for RUN and ERROR
- Connection of the field cables with plug-in terminals
- Module can be hot swapped while powered up
- Certificates for Europe



Operation

The input signals are detected while multiplexed. During measurement a measuring current of 0.2 mA flows. Each input is individually monitored for open- and short-circuits.

Up to 8 resistance thermometers or remote potentiometers can be monitored in 2-, 3- or 4-wire technique. If required, line balancing at a 2-wire circuit can be implemented by means of the keyboard of the corresponding CPU & Power Module.

The interface of the Temperature Input Module with the internal data bus of the BusRail is designed with redundancy.

Further information regarding this module



See Chapter 7.6.6 (Connection allocation) and Chapter 13.3.6 (Technical data).

4.6.7 Temperature Input Module mV

Remote I/O system
 Temperature Input Module mV
 Type 9481

- For thermocouples (DIN, IEC) and mV-sensors
- Suitable for grounded thermocouples
- 8 channels
- Intrinsically safe EEx ia IIC inputs
- Installation in Zone 1 or Zone 2 / Division 2
- Internal or external reference junction
- Galvanic isolation between inputs and between inputs and system
- Open-circuit monitoring for each field circuit
- Functions can be parameterized
- Conversion time 800 ms for 8 channels
- Status LEDs for RUN and ERROR
- Connection of the field cables with plug-in terminals
- Module can be hot swapped while powered up
- Certificates for Europe



Operation

The input signals are detected while multiplexed and an A/D conversion is executed. Each input is individually monitored for open-circuits.

Up to 8 thermocouples or mV signals can be monitored. The inputs are galvanically isolated functionally from each other so that disturbing earth loops are prevented at earthed thermocouples.

Compensation of the reference-junction temperature is carried internally at the terminals. Alternatively it is carried out externally by means of a resistance thermometer at a Temperature Input Module R (type 9480) of the same field station.

The interface of the Temperature Input Module with the internal data bus of the BusRail is designed with redundancy.

Further information regarding this module

	<p>See Chapter 7.6.7 (Connection allocation) and Chapter 13.3.7 (Technical data).</p>
-------------------------------------------------------------------------------------	---------------------------------------------------------------------------------------

4.6.8 Analog Output Module

Remote I/O system
Analog Output Module
Type 9465

- Control of I/P converters, control valves
- 8 channels
- Intrinsically safe EEx ia IIC outputs
- Installation in Zone 1 or Zone 2 / Division 2
- Signal 0 .. 20 mA or 4 .. 20 mA
- Load up to 750 ohms
- Galvanic isolation between outputs and system
- Open-circuit and short-circuit monitoring for each field circuit
- Functions can be parameterized
- 12 bit resolution
- Conversion time 5 ms for 8 channels
- Status LEDs for RUN and ERROR
- Connection of the field cables with plug-in terminals
- Module can be hot swapped while powered up
- Certificates for Europe



Operation

The output circuit generates a current signal of 0 .. 20 mA or 4 .. 20 mA for the corresponding channel. All outputs are short-circuit proof. The voltage at the respective output is measured and compared with the desired value. If there is a deviation, e.g. during open-circuit or short-circuit, an alarm is generated.

Communication with the CPU & Power Module is achieved using the address and data circuits of the BusRail, which also contain the circuits for the power supply to the module.

The interface of the Analog Output Module with the internal data bus of the BusRail is designed with redundancy.

Further information regarding this module



See Chapter 7.6.8 (Connection allocation) and Chapter 13.3.8 (Technical data).

4.6.9 Analog Output Module HART

Remote I/O system
 Analog Output Module HART
 Type 9466

- Control of HART control valves
- 8 channels
- Intrinsically safe EEx ia IIC outputs
- Installation in Zone 1 or Zone 2 / Division 2
- HART communication possible
- Load up to 750 ohms
- Galvanic isolation between outputs and system
- Open-circuit and short-circuit monitoring for each field circuit
- Functions can be parameterized
- 12 bit resolution
- Conversion time 5 ms for 8 channels
- Status LEDs for RUN and ERROR
- Connection of the field cables with plug-in terminals
- Module can be hot swapped while powered up
- Certificates for Europe



Operation

The output circuit generates a current signal of 0 .. 20 mA or 4 .. 20 mA for the corresponding channel. All outputs are short-circuit proof. The voltage at the respective output is measured and compared with the desired value. If there is a deviation, e.g. during open-circuit or short-circuit, an alarm is generated.

The integrated HART multiplexer permits bi-directional HART communication. The module is "transparent" for the HART commands. The HART information is transferred from the CPU & Power Module via the ServiceBus; alternatively via the fieldbus if this service is supported.

Communication with the CPU & Power Module is achieved using the address and data circuits of the BusRail, which also contain the circuits for the power supply to the module.

The interface of the Analog Output Module with the internal data bus of the BusRail is designed with redundancy.

Analog control valves (non-HART) can also be operated.

Further information regarding this module

	<p>See Chapter 7.6.9 (Connection allocation) and Chapter 13.3.9 (Technical data).</p>
-------------------------------------------------------------------------------------	---------------------------------------------------------------------------------------

4.6.10 Digital Input Module

Remote I/O system

Digital Input Module NAMUR

Type 9470

- For contacts and NAMUR proximity switches
- 16 channels
- Intrinsically safe EEx ia IIC inputs
- Installation in Zone 1 or Zone 2 / Division 2
- Galvanic isolation between inputs and system
- Open-circuit and short-circuit monitoring for each field circuit
- Functions can be parameterized
- Two channels can be parameterized as frequency inputs or counters up to 20 kHz
- Conversion time 1 ms
- Status LEDs for RUN and ERROR
- Connection of the field cables with plug-in terminals
- Module can be hot swapped while powered up
- Certificates for Europe
- 100 % replacement for Type 9470/12-16-11



Operation

The inputs are individually powered with ca. 8V/8 mA, in compliance with DIN 19234 (NAMUR). All inputs are short-circuit proof and individually monitored for open-circuits and short-circuits.

Channels 14 and 15 are equipped with rapid comparators and can also be parameterized for frequency measurement or as pulse counters. In this operation mode, the input signals of channels 14 and 15 are also transferred into the data word for the digital inputs.

Communication with the CPU & Power Module is achieved using the address and data circuits of the BusRail, which also contain the circuits for the power supply to the module.

The interface of the Digital Input Module with the internal data bus of the BusRail is designed with redundancy.

Contacts with resistors can be connected (1.2 kOhm in series, 15 kOhm in parallel) for open-circuit and short-circuit monitoring.

Further information regarding this module



See Chapter 7.6.10 (Connection allocation) and Chapter 13.3.10 (Technical data).

4.6.11 Digital Input Module 24 V

Remote I/O system
 Digital Input Module 24 V
 Type 9471

- For 0 / 24 V signals
- 16 channels
- Without explosion protection for installation in safe areas
- Galvanic isolation between inputs and system
- Functions can be parameterized
- Two channels can be parameterized as frequency inputs or counters up to 20 kHz
- Conversion time 1 ms
- Status LEDs for RUN and ERROR
- Connection of the field cables with plug-in terminals
- Module can be hot swapped while powered up



Operation

The inputs are passive voltage inputs for 0/24 V signals. All 16 channels have a common earth (0 V). Channels 14 and 15 are equipped with rapid comparators and can also be parameterized for frequency measurement or as pulse counters. In this operation mode, the input signals of channels 14 and 15 are also transferred into the data word for the digital inputs. Communication with the CPU & Power Module is achieved using the address and data circuits of the BusRail, which also contain the circuits for the power supply to the module. The interface of the Digital Input Module with the internal data bus of the BusRail is designed with redundancy.

Further information regarding this module

	<p>See Chapter 7.6.11 (Connection allocation) and Chapter 13.3.11 (Technical data).</p>
-------------------------------------------------------------------------------------	-----------------------------------------------------------------------------------------

4.6.12 Digital Output Module

Remote I/O system
Digital Output Module
Type 9475

- For Ex i solenoid valves, piezo and booster-valves
- 8 / 4 channels
- Intrinsically safe EEx ia IIC outputs
- Installation in Zone 1 or Zone 2 / Division 2
- Galvanic isolation between outputs and system
- Open-circuit and short-circuit monitoring for each field circuit
- Electrical values optimized for commercial Ex i solenoid valves
- Functions can be parameterized
- Conversion time 1 ms
- Status LEDs for RUN and ERROR
- Connection of the field cables with plug-in terminals
- Module can be hot swapped while powered up
- Certificates for Europe



Operation

The outputs are short-circuit proof and powered with electrical values in compliance with type specifications.

All channels are individually monitored for open- and short-circuits. Monitoring can be switched off individually in each channel using parameters. Open-circuit monitoring is also active when the switching state is OFF.

Communication with the CPU & Power Module is achieved using the address and data circuits of the BusRail, which also contain the circuits for the power supply to the module.

The interface of the Digital Output Module with the internal data bus of the BusRail is designed with redundancy.

Further information regarding this module



See Chapter 7.6.12 (Connection allocation) and Chapter 13.3.12 (Technical data).

4.6.13 Digital Output Module Relay

Remote I/O system
 Digital Output Module Relay
 Type 9477

- Output relay contact normally open
- 8 channels
- Without explosion protection for installation in safe areas
- Galvanic isolation between outputs and system
- Functions can be parameterized
- Switching time 10 ms
- Status LEDs for RUN and ERROR
- Connection of the field cables with plug-in terminals
- Module can be hot swapped while powered up



Operation

Each output is an individual floating contact per channel. They are operated as normally open contacts. Logic 0 = contact open; logic 1 = contact closed.

Communication with the CPU & Power Module is achieved using the address and data circuits of the BusRail, which also contain the circuits for the power supply to the module.

The interface of the Digital Output Module with the internal data bus of the BusRail is designed with redundancy.

Further information regarding this module

	<p>See Chapter 7.6.13 (Connection allocation) and Chapter 13.3.14 (Technical data).</p>
-------------------------------------------------------------------------------------	-----------------------------------------------------------------------------------------

4.6.14 BusRail

Remote I/O system

BusRail

Type 9494

- Backplane bus for the I.S. 1 system, consisting of data bus, PowerBus and address circuits
- Installation in Zone 2 / Division 2 or Zone 1
- For 2 or 4 modules
- Installation on 35 mm DIN rails
- BusRail can be interconnected for up to 18 modules
- BusRail can be distributed between several segments
- Passive component with high availability



Operation

The BusRail is fitted into a 35 mm DIN rail and provides internal electrical connection between the CPU & Power Module and the I/O modules. The BusRail is built up in a purely passive way. It consists of the internal data bus, the PowerBus and the address circuits for the I/O modules. The internal bus is built up with redundancy. By design the PowerBus has extremely high availability.

The BusRail is available in various lengths, for 2 or 4 modules (BR2 or BR4). Terminations are required both at the beginning and at the end. The terminations are designated as BusRail begin and BusRail end and are available with Sub-D plugs. The use of a connection cable permits several BusRail segments to be built up in one enclosure.

Further information regarding BusRails



See Chapter 5.3.3 (Combination options) and Chapter 13.3.15 (Technical data).

4.6.15 Terminations

Remote I/O system

Termination

Type 9494/A..

- Termination of a BusRail segment for begin and end
- Optional with Sub-D plug
- Passive component with high availability
- Certificates for Europe, USA, Canada

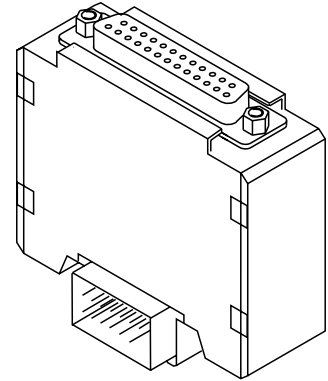

Termination

Depending on the version, it is possible to use a termination with or without a Sub-D plug.

By using the Sub-D plug, it is possible to distribute a BusRail across several rails.

Further information regarding terminations

	<p>See Chapter 7.8.1 (Connection allocation) and Chapter 13.4.7 (Dimensions).</p>
-------------------------------------------------------------------------------------	-----------------------------------------------------------------------------------

OPERATING INSTRUCTIONS FOR THE I.S. 1 SYSTEM

4.7 System connections and interfaces

There are four types of connections in the I.S. 1 system.

These are:

- Connections for fieldbus and ServiceBus
- Connections for data and addresses of the internal buses
- Connections for field devices
- Connection for power supply to the CPU & Power Module

Overview

Module	Connection type/ interface	Function
CPU & Power Modules	3 x Sub-D plug	1x connection to the fieldbus 1x connection to the redundant fieldbus 1x connection to the Service-Bus
	1 x screw terminal	Power supply
	1 x BusRail plug	Communication and control of I/O modules, power supply for I/O modules
	1 x data plug	For system expansion (in preparation)
I/O module	4, 8 or 16 channels, screw terminals or spring terminals	Connection of field devices
	1 x BusRail plug	Communication with the CPU & Power, inclusion of power supply
BusRail	Termination with Sub-D plug	Communication from the CPU & Power Module to another rail via the internal bus

Tab. 4-8 Overview of the system connections and interfaces

4.7.1 CPU & Power Module for Zone 1, Type 9440/12

Fig. 4-13 shows the base for the CPU & Power Module in Zone 1. The base includes a total of 7 connections.

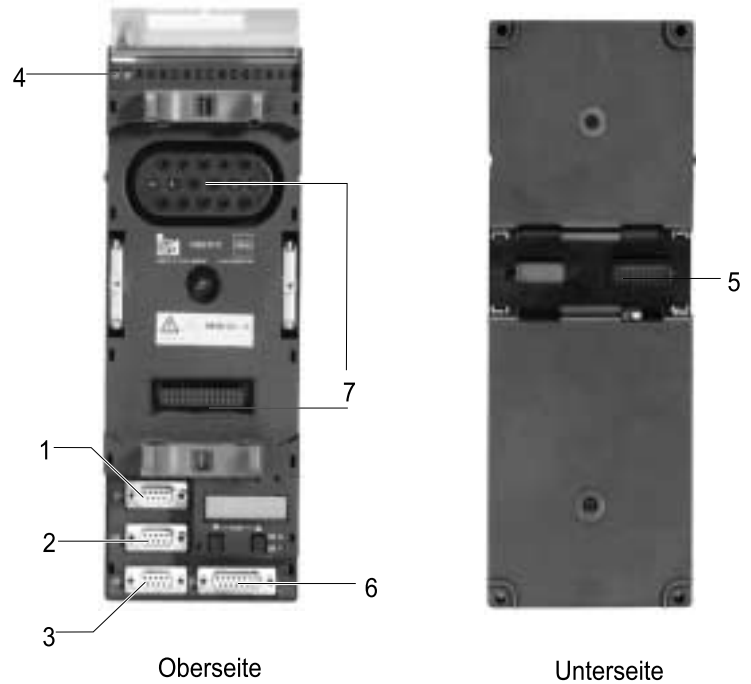

Fig. 4-13 Connections of the CPU & Power Module, Type 9440/12, for Zone 1

- 1 Fieldbus
- 2 Redundant fieldbus
- 3 ServiceBus
- 4 Power supply
- 5 BusRail plug (underneath)
- 6 Data plug
- 7 Sockets for the CPU & Power Module

4.7.2 Function of the CPU & Power Module connections, Type 9440/12 for Zone 1

Pos. No.	Connection on the CPU & Power Module	Function
1	Fieldbus	Data transmission from and to the automation devices
2	Redundant fieldbus	Data transmission from and to the automation devices
3	ServiceBus	Special interface for parameterization of the I/O modules
4	Power supply	Integrated power supply Power supply for up to 8 I/O modules
5	BusRail plug (underneath)	Data transmission, forwarding of addresses and I/O modules power supply
6	Data plug	For system expansion
7	Sockets for the CPU & Power Module	Connection of base and CPU & Power Module

Tab. 4-9 Overview of the function of the CPU & Power Module connections, Type 9440/12 for Zone 1

4.7.3 CPU & Power Module, Type 9440/15 for Zone 2

Fig. 4-14 shows the CPU & Power Module with the label carrier open. The CPU & Power Module contains a total of six connections.

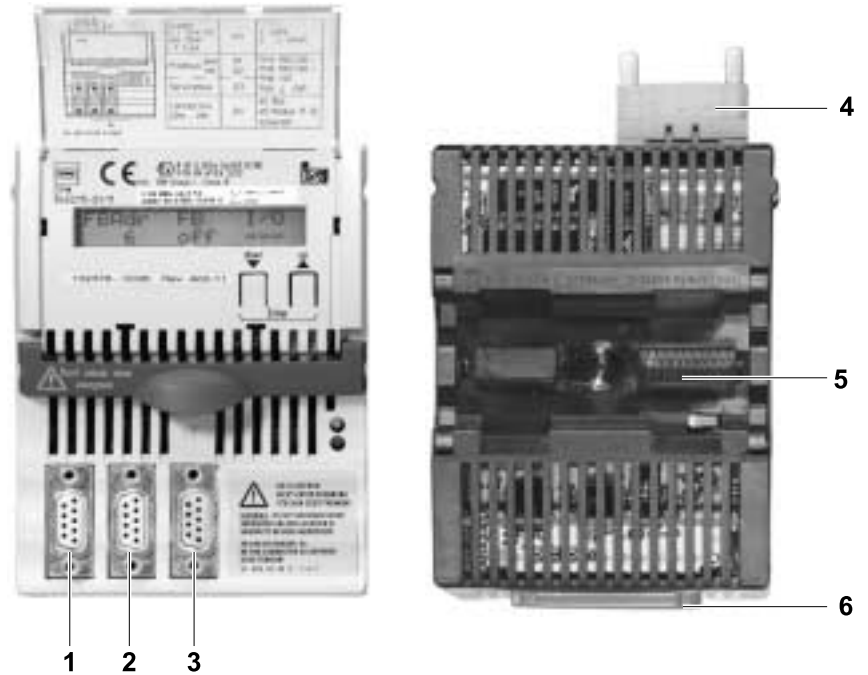

Fig. 4-14 Connections of the CPU & Power Module, Type 9440/15 for Zone 2

- 1 Fieldbus
- 2 Redundant fieldbus
- 3 ServiceBus
- 4 Power supply
- 5 BusRail plug
- 6 Data plug

4.7.4 Function of the CPU & Power Module connections, Type 9440/15 for Zone 2

Pos. No.	Connection on the CPU & Power Module	Function
1	Fieldbus	Data transmission from and to the automation devices
2	Redundant fieldbus	Data transmission from and to the automation devices
3	ServiceBus	Special interface for parameterization of the I/O modules
4	Power supply	Integrated power supply Power supply for up to 16 I/O modules
5	BusRail plug	Data transmission, forwarding of addresses and I/O modules power supply
6	Data plug	For system expansion

Tab. 4-10 Overview of the function of the CPU & Power Module connections, Type 9440/15 for Zone 2

4.7.5 I/O module

Fig. 4-15 shows the I/O module from the top (left picture) and from the bottom (right picture).

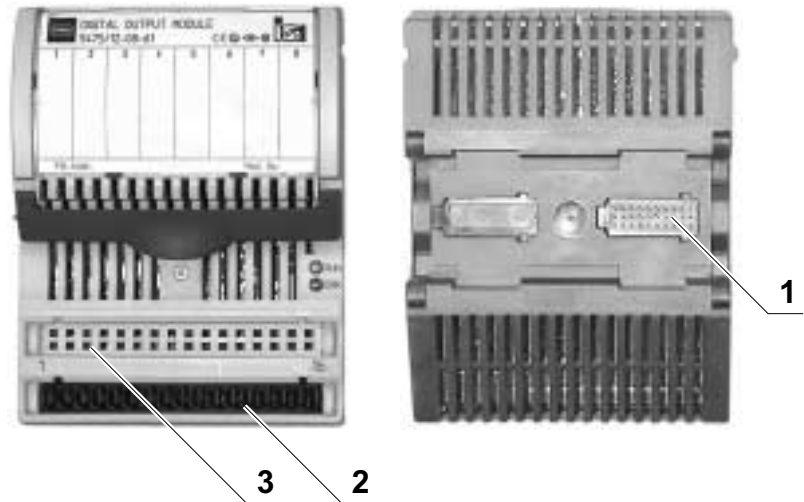

Fig. 4-15 I/O module connections

- 1 BusRail plug
- 2 Terminals for field devices
- 3 Terminals for field devices (shown here with closed covers)

4.7.6 Function of the I/O module connections

Pos. No.	I/O module connection	Function
1	BusRail plug	Data transmission, forwarding of addresses and I/O modules power supply
2	Terminals for field devices	Inputs or outputs Terminals 1 to 16
3	Terminals for field devices	Inputs or outputs Terminals 17 to 32, occupied or unoccupied depending on type

Tab. 4-11 Overview of the function of the I/O module connections

4.7.7 BusRail and terminations

Fig. 4-16 shows an option for distributing the BusRail on two DIN rails and connecting them via the terminations.

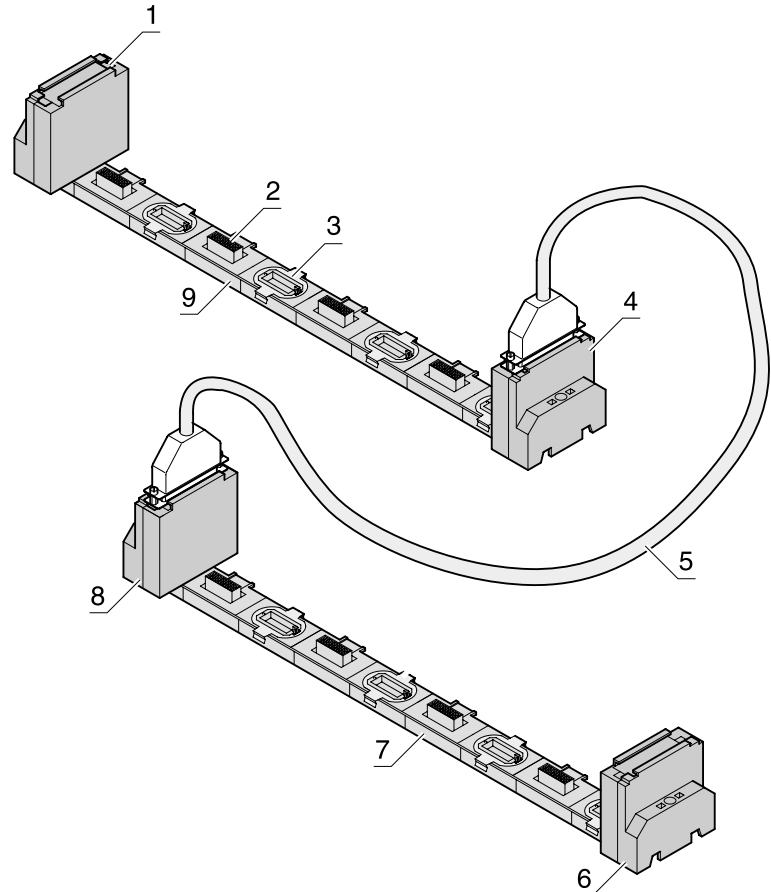

Fig. 4-16 Connection of two BusRails via the terminations

- 1 Termination "begin" Type 9494/A1-B0
- 2 BusRail plug for electrical and mechanical connection of the I/O modules
- 3 Earth clamp
- 4 Termination "end Sub-D" Type 9494/A2-E0
- 5 Connection cable
- 6 Termination "end" Type 9494/A1-E0
- 7 BusRail, second section of the rail
- 8 Termination "begin Sub-D" Type 9494/A2-B0
- 9 BusRail, first section of the rail

4.7.8 Function of the connections, circuits and terminations of the BusRail (example configuration)

The components in the distribution of the BusRail displayed in *Fig. 4-16* have various functions. These functions are summarized in *Tab. 4-12*.

Pos. No.	Description	Function
1	Termination begin	<ul style="list-style-type: none"> • Mechanical protection against entry of foreign bodies on the side of the BusRail
2	BusRail plug	<ul style="list-style-type: none"> • Data transmission, forwarding of addresses and I/O modules power supply
3	Earth clamp	<ul style="list-style-type: none"> • For earthing the modules. The clamps are snapped over the earthing rail
4	Termination end Sub-D	<ul style="list-style-type: none"> • Mechanical protection against entry of foreign bodies on the side of the BusRail • Data transmission, forwarding of addresses and I/O modules power supply on the second rail
5	Connection cable	<ul style="list-style-type: none"> • Data transmission, forwarding of addresses and I/O modules power supply on the second rail
6	Termination end	<ul style="list-style-type: none"> • Mechanical protection against entry of foreign bodies on the side of the BusRail
7	BusRail (part 2)	<ul style="list-style-type: none"> • Data transmission, forwarding of addresses and I/O modules power supply • Fixing of the I/O modules
8	Termination begin Sub-D	<ul style="list-style-type: none"> • Mechanical protection against entry of foreign bodies on the side of the BusRail • Data transmission, forwarding of addresses and I/O modules power supply on the second rail
9	BusRail	<ul style="list-style-type: none"> • Data transmission, forwarding of addresses and I/O modules power supply • Fixing of the I/O modules

Tab. 4-12 Connections, circuits and terminations of the BusRail

OPERATING INSTRUCTIONS FOR THE I.S. 1 SYSTEM

4.8 Display and operating elements

The display and operating elements of the modules serve to set the field-bus addresses on the CPU & Power Module and for basic local error detection.

Overview

Module	Display / operating element
CPU & Power Module	1x label carrier 1x Display 2x input keys 1x LED red 1x LED green
I/O module	1x label carrier 1x LED red 1x LED green

Tab. 4-13 Overview of the system display and operating elements

4.8.1 CPU & Power Module, Type 9440/12 for Zone 1

Fig. 4-17 shows the display and operating elements of the CPU & Power Module for Zone 1. They are built into the base.



Fig. 4-17 Overview of the display and operating elements of the CPU & Power Module, Type 9440/12 for Zone 1

- 1 Display
- 2 Input key (left)
- 3 Input key (right)
- 4 Green LED (RUN)
- 5 Red LED (ERROR)

4.8.2 Function of the display and operating elements of the CPU & Power Module, Type 9440/12 for Zone 1

Pos. No.	Display or operating element	Function
1	Display	Displays fieldbus addresses, errors and module parameters
2	Input key (left)	For settings (e.g. fieldbus address) and selection of displays (e.g. system status)
3	Input key (right)	For settings (e.g. fieldbus address) and selection of displays (e.g. system status)
4	Green LED (RUN)	Shows the correct function of the CPU & Power Module in normal operation
5	Red LED (ERROR)	Shows an error in the CPU & Power Module or in one of the I/O modules

Tab. 4-14 Overview of the function of the display and operating elements of the CPU & Power Module, Type 9440/12 for Zone 1

Further information regarding display and operating elements

	See Chapter 8.2 (Setting the fieldbus address) and Chapter 11.3 (Error detection in the CPU & Power Module).
-------------------------------------------------------------------------------------	--------------------------------------------------------------------------------------------------------------

4.8.3 CPU & Power Module, Type 9440/15, for Zone 2

Fig. 4-18 shows the display and operating elements of the CPU & Power Module with the label carrier open. The label carrier is printed with the allocation plan for the connections.

All important information regarding ex protection is printed on the module enclosure.

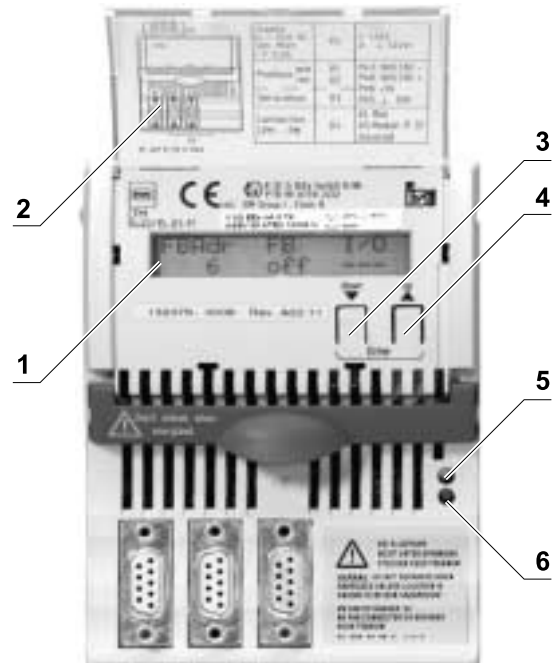

Fig. 4-18 Overview of the display and operating elements of the CPU & Power Module, Type 9440/15, for Zone 2

- 1 Display
- 2 Label carrier (tag holder)
- 3 Input key (left)
- 4 Input key (right)
- 5 Green LED (RUN)
- 6 Red LED (ERROR)

4.8.4 Function of the display and operating elements of the CPU & Power Module, Type 9440/15 for Zone 2

Pos. No.	Display or operating element	Function
1	Display	Displays fieldbus addresses, errors and module parameters
2	Label carrier	Contains the connector allocation plan
3	Input key (left)	For settings (e.g. fieldbus address) and selection of displays (e.g. system status)
4	Input key (right)	For settings (e.g. fieldbus address) and selection of displays (e.g. system status)
5	Green LED (RUN)	Shows the correct function of the CPU & Power Module in normal operation
6	Red LED (ERROR)	Shows an error in the CPU & Power Module or in one of the I/O modules

Tab. 4-15 Overview of the function of the display and operating elements of the CPU & Power Module, Type 9440/15 for Zone 2

Further information regarding display and operating elements

	See Chapter 8.2 (Setting the fieldbus address) and Chapter 11.3 (Error detection in the CPU & Power Module).
-------------------------------------------------------------------------------------	--------------------------------------------------------------------------------------------------------------

4.8.5 I/O module

Fig. 4-19 shows the display elements of the I/O module. There are no further display or operating elements located under the label carrier. The terminal allocation plan is printed on the inside of the label carrier.

All important information regarding ex protection is printed on the module enclosure.

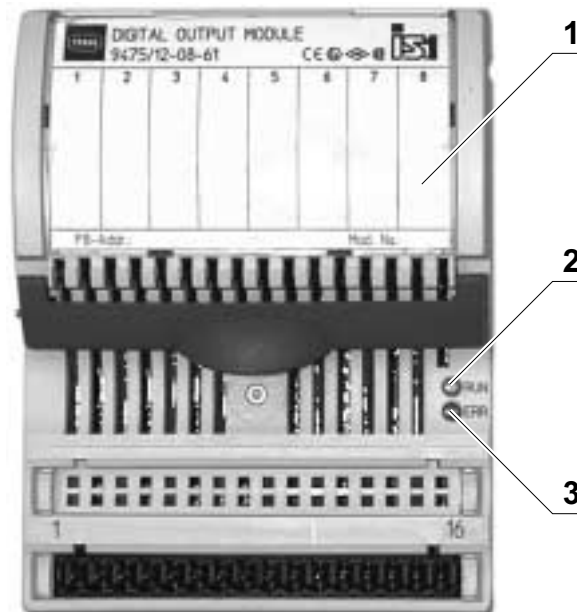

Fig. 4-19 Overview of the I/O module display elements

- 1 Label carrier
- 2 Green LED (RUN)
- 3 Red LED (ERROR)

4.8.6 Function of the I/O module display elements

In normal I/O module operation the LED is green. If there is a fault or failure in the module, the LED blinks according to the specified error code.

Pos. No.	Display element	Function
1	Label carrier	Contains the terminal allocation plan
2	Green LED (RUN)	Shows the correct function of the I/O module in normal operation
3	Red LED (ERROR)	Show a fault in the I/O module or in one of the connected field circuits

Tab. 4-16 Overview of the function of the I/O module displays

Further information regarding the displays of the I/O module

	See Chapter 11.4.2 (Error detection in the I/O module).
------------------------------------------------------------------------------------	---------------------------------------------------------

OPERATING INSTRUCTIONS FOR THE I.S. 1 SYSTEM
