



Operating Instructions



ORCA Device Platform
ORCA01E* / ORCA01M*
Panel-mount devices / Operator Stations
Panel PC / Thin Clients
Direct Monitor



THE STRONGEST LINK.

Doc. no.: 2022 41 7000 0

HW-Rev. E/M5xA: 01.01.01
HW-Rev. E/M79A: 01.01.01

Operating Instructions Version: 01.00.05
Issue: 01.09.2023

Article number: 309310

Table of contents

	Description	Page
	Table of contents	2
1	General information	7
1.1	Manufacturer	7
1.2	Legal notice	7
1.2.1	Trademark	7
1.2.2	Disclaimer	7
1.3	About these operating instructions	8
1.3.1	Target group	8
1.3.2	How to use this manual	8
1.3.3	Application	8
1.4	Further documents	8
1.5	Conformity with standards and regulations	9
1.5.1	Certificates	9
1.5.2	Certificates	9
	Europe (CE / ATEX)	9
	Global (IECEX)	9
1.5.3	Summary of applied standards	10
1.5.3.1	ATEX / IECEX	10
1.5.3.2	EMC Directive 2014/30/EU	10
1.5.3.3	Radio equipment directive 2014/53/EU	10
1.5.3.4	Low voltage directive 2014/35/EU	10
1.5.3.5	RoHS Directive 2011/65/EU	10
2	Explanation of symbols	11
2.1	Symbols used in these Operating Instructions	11
2.2	Warning notes	11
2.3	Symbols on the device	12
3	Safety	13
3.1	Intended use	13
3.2	Predictable improper use	14
3.3	Personnel qualification	14
3.4	Special conditions of use	14
3.5	Residual risks	15
3.5.1	Explosion hazard	15
3.5.2	Risk of injury	16
3.5.3	Device damage	17
3.6	Industrial Security	17
4	Function and device design	18
4.1	Features and versions	18
4.1.1	Options	18
4.1.2	Panel-mount device	18
4.1.2.1	D-Box	18
4.1.2.2	E-Box	19
4.1.2.3	Combination options of D-Box and E-Box	19
4.1.3	Operator Station	19

4.1.3.1	Card reader for access control	20
4.1.4	Accessories	20
4.1.5	Scope of delivery	21
4.1.5.1	Panel-mount device	21
4.1.5.2	Operator Station	21
4.2	Device design	22
4.2.1	Panel-mount device	22
4.3	Type code	23
4.3.1	Family code	23
4.3.2	Type key code field system	24
4.4	Available configuration versions	28
4.5	Dimensions	29
4.5.1	Panel-mount devices	29
4.5.1.1	Front	29
4.5.1.2	Side	29
4.5.1.3	Cutout	30
4.5.2	ORCA-OFR Operator Station	31
4.5.3	ORCA-OFR Operator Station with keyboard	31
4.6	Connection box	32
4.6.1	E-Box Standard	32
4.6.2	E-Box PRO	33
4.7	Operating elements	34
4.7.1	Sensors	35
4.8	LED status display	35
4.9	Markings on the device	36
4.9.1	Position	36
4.9.1.1	Field system label	36
4.9.1.2	Label on E-Boxes	36
4.9.1.3	Label on display boxes	37
4.9.1.4	Warning label	37
4.9.1.5	Safety label	38
4.9.2	Design of label / type plate	38
4.9.2.1	Field system label / type plate	38
4.9.2.2	E-Box Label	39
4.9.2.3	D-Box Label	39
4.9.2.4	Key to E-Box and D-Box labels	40
4.10	Ex marking	40
4.10.1	ATEX / IECEx	40
5	Operating systems and drivers	41
5.1	Windows® 10 IoT Enterprise 2019 LTSC operating system	41
5.1.1	Recovery	41
5.1.2	Proprietary Windows installations and drivers	41
5.2	Data back-up	41
5.2.1	Recovery Stick	41
5.2.2	Back-up	41
5.2.3	Switching off / closing down	42
5.2.4	Loss of data	42

5.3	License sticker	42
5.4	UPDD touch driver	42
6	Transport and storage	43
7	Unpacking	43
8	Mounting and installation	44
8.1	Note on mounting and installation	44
8.2	Requirements for site of installation	44
8.3	Mounting types	45
8.4	Front installation	45
8.4.1	Panel-mount – installation	45
8.5	Installation	48
8.5.1	General information on electric connection	48
8.5.2	Connecting device to power supply	49
8.5.3	Grounding the device	49
8.5.4	Connecting data cable	49
8.5.5	Mounting the cover of the connection box	49
8.5.6	Connecting associated equipment	50
8.5.7	Cable glands	50
8.5.8	Electric connections of interfaces X1, X2, X3, X4, X5, X6, X7, X9, X10, X11, X12 and X13	51
8.6	Using USB interfaces	52
9	Initial start-up	53
10	(Re-) Commissioning	53
11	Operation	54
11.1	Operating the touch display	54
11.2	Switching the device on and off	55
11.2.1	Without optional on/off button	55
11.2.2	With optional on/off button	55
11.3	Teaming function	55
12	Maintenance, overhaul and repair	56
12.1	Changing the battery	56
12.2	Servicing	56
12.3	Maintenance	57
12.4	Repair	57
12.4.1	Mounting / dismantling the modules	57
13	Returning the device	59
14	Cleaning	59
15	Disposal	59
16	Accessories	59
17	Appendix A	60
17.1	Technical data E/M5xA	60
17.1.1	General	60
17.1.2	Electrical data	60
17.1.2.1	Electrical data - device protection	62
17.1.3	Display	63
17.1.4	Ambient conditions	63
17.1.5	Mechanical data	64

17.2	Technical data E/M79A	65
17.2.1	General	65
17.2.2	Electrical data	65
17.2.2.1	Electrical data - device protection	65
17.2.3	Display	66
17.2.4	Ambient conditions	66
17.2.5	Mechanical data	67
17.3	Cable glands	68
17.3.1	E-Box Standard	68
17.3.2	E-Box PRO	69
17.4	Overview Hardware Revision ORCA01	70
18	Appendix B	71
18.1	Connection values	71
18.2	Intrinsically safe interfaces	71
18.2.1	X9 PB – on/off button (Ex ia)	71
18.2.2	X5 / X6 – USB 4/5 (Ex ia)	71
18.2.3	X7 / X8 – USB 6 (Ex ib)	71
18.3	Optical interfaces	72
18.3.1	X15 / X16 – FO 1 / FO 2 type FX	72
18.3.2	X15 / X16 – FO 1 / FO 2 type SX	72
18.3.3	X15 / X16 – FO 1 / FO 2 type LX	72
18.4	Non intrinsically safe interfaces (Ex e)	72
18.4.1	X1 – Power supply	72
18.4.2	X2 / X10 – copper1 / copper2	72
18.4.3	X3 / X11 / X12 / X13 – USB	72
18.4.4	X4 – RSxxx	72
19	Appendix C	73
19.1	Connection overview terminal assignment	73
19.1.1	E-Box Standard	73
19.1.1.1	Ex e terminals	73
19.1.1.2	Ex i terminals	74
19.1.2	E-Box PRO	75
19.1.2.1	Ex e terminals	75
19.1.2.2	Ex i terminals	78
19.1.3	Direct Monitor	79
19.1.3.1	Ex e terminals	79
19.1.3.2	Ex i terminals	79
20	Appendix D	80
20.1	Variation of operating temperature range	80
21	Appendix E	82
21.1	Disposal / restricted substances	82
21.1.1	Declaration of substances and restricted substances	82
21.1.1.1	Declarable substance groups	82
21.1.1.2	RoHS directive 2011/65/EC	82
21.1.1.3	IMO Resolution MEPC.269(68)	82
22	Appendix F	83
22.1	Material resistance	83

22.1.1	Material	83
22.1.1.2	Powder coating	84
22.1.1.3	Front plate seal	84
23	Appendix G	93
23.1	Defective pixels	93
23.1.1	Terminology	93
23.1.2	Display specification	94
23.2	Optical specification front glass	95
23.2.1	Test criteria	95
23.3	Optical acceptance of surfaces	97
23.3.1	Optical acceptance glass	97
23.3.2	Optical acceptance printing	98
23.3.3	Optical acceptance, other surfaces	98
24	Appendix H	100
24.1	Control Drawing	100
25	Appendix I	105
25.1	Declarations of conformity	105
25.1.1	EU	105
25.1.1.1	ORCA01E	105
25.1.1.2	ORCA01M	106
25.2	Declaration of conformity for Equipment Compilation	107
26	Appendix J	108
26.1	Release notes	108

1 General information

1.1 Manufacturer

R. STAHL HMI Systems GmbH
Adolf-Grimme-Allee 8
50829 Köln
Germany

Sales Support

Tel.: +49 221 768 06 – 1200
E-mail: sales.dehm@r-stahl.com

Technical Support

Tel.: +49 221 768 06 – 5000
E-mail: support.dehm@r-stahl.com

General

Fax: +49 221 768 06 – 4200
Internet: r-stahl.com

1.2 Legal notice

1.2.1 Trademark

The terms and names used in this document are registered trademarks and / or products of the companies in question.

1.2.2 Disclaimer

- All rights reserved.
- This document may not be reproduced in whole or in part except with the written consent of the publisher.
- This document may be subject to change without notice.

Any warranty claims are limited to the right to demand amendments. Liability for any damage that might result from the contents of these instructions or all other documentation is limited to clear cases of premeditation.

We reserve the right to amend our products and their specifications at any time, provided it is in the interest of technical progress. The information in the current manual (online or on CD / DVD / USB-stick) or in the operating instructions included in the delivery applies.

1.3 About these operating instructions

1.3.1 Target group

These operating instructions are intended for the following groups of people:

- Project engineers
- Electricians and installers
- Operators
- Operating staff
- Maintenance staff

1.3.2 How to use this manual

- Read these operating instructions, especially the safety notes, carefully before use.
- Take note of all other applicable documents (see also chapter [1.4 Further documents](#)).
- Keep the operating instructions for the entire length of the service life of the device.
- Make the operating instructions accessible to operating and maintenance staff at all times.
- Pass the operating instructions on to each subsequent owner or user of the device.
- Update the operating instructions every time R. STAHL issues an amendment.

1.3.3 Application

Operating Instructions version:	01.00.05
Hardware revision:	ORCA01E*: 01.01.01
	ORCA01M*: 01.01.01

The following operating instructions apply to the following systems:

ORCA01E* / ORCA01M*	Panel PC / Thin Clients
	Direct Monitor

The original instructions are the German edition.
They are legally binding in all legal affairs.

1.4 Further documents

- Certificate compilation ORCA01* (CE_ORCA01)



For documents in other languages, see [r-stahl.com](https://www.r-stahl.com).

1.5 Conformity with standards and regulations

1.5.1 Certificates

	Certificates: r-stahl.com
	The devices have IECEx approval. See IECEx homepage: https://www.iecex-certs.com/#/home to view the certificate
	Further national certificates can be downloaded via the following link: https://r-stahl.com/en/global/support/downloads/

1.5.2 Certificates

The following certificates are valid for all devices:

Synonym	Scope of validity	Valid until	Certificate number
CE / ATEX	Europe	unlimited	UL 23 ATEX 2902X
IECEx	Global	unlimited	IECEx UL 23.0007X

1.5.3 Summary of applied standards**1.5.3.1 ATEX / IECEx**

Standard	Classification
IEC 60079-0 : 2018	General requirements
IEC 60079-5 : 2015	Protection by powder filling "q"
IEC 60079-7 : 2015 + A1 : 2018	Protection by increased safety "e"
IEC 60079-11 : 2012	Protection by intrinsic safety "i"
IEC 60079-31 : 2014	Protected by enclosures "t" (dust ignition protection)

1.5.3.2 EMC Directive 2014/30/EU

Standard	Classification
EN 61000-3-2 : 2014	Limiting values for harmonic current emissions
EN 61000-3-3 : 2013	Limiting values for voltage changes
EN 61000-6-2 : 2005 + AC : 2005	Immunity industrial areas
EN 61000-6-3 : 2007 + A1 : 2011 + AC : 2012	Emitted interference residential areas
EN 61000-6-4 : 2007 + A1 : 2011	Emitted interference industrial areas
EN 55035 2017 :	Immunity of multi-media devices
EN 55032 2015 :	Emitted interference of multi-media devices

1.5.3.3 Radio equipment directive 2014/53/EU

Standard	Classification
ETSI EN 300330 V2.1.1 : 2017-02	Short-range devices (SRD)
ETSI EN 301489-1 V2.2.3 : 2019-11	Technical requirements
ETSI EN 301489-3 V2.1.1 : 2019-01	Specific rating for short-range devices (SRD)

1.5.3.4 Low voltage directive 2014/35/EU



Standard	Classification
EN 62368-1 : 2014 + AC : 2015	Devices for audio / video, information and communication technology - safety requirements

1.5.3.5 RoHS Directive 2011/65/EU

Standard	Classification
EN IEC 63000 : 2018	Technical documentation for the assessment of electrical and electronic equipment with regard to the restriction of hazardous substances

2 Explanation of symbols

2.1 Symbols used in these Operating Instructions

Symbol	Meaning
	Useful hint for making work easier, important note
	Reference to another chapter, another section, another documentation or another web page.



2.2 Warning notes

	Dangerous situation which can result in fatal or severe, life-changing injuries if the safety measures are not complied with.
---	---



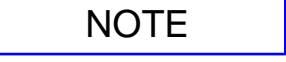



	Dangerous situation which can result in severe injuries if the safety measures are not complied with.
---	---

	Dangerous situation which can result in minor injuries if the safety measures are not complied with.
---	--

	Dangerous situation which can result in material damage if the safety measures are not complied with.
---	---

Symbol	Meaning
	Heat hazard
	Laser radiation hazard
	Electrostatic charge hazard

2.3 Symbols on the device

Symbol	Meaning
	Device certified for hazardous areas according to ATEX directive.
	Device marking according to EU directive
0158	ID number of monitoring body
	Marking according to WEEE directive 2012/19/EU
	Warning - important information
	Warning of hazardous voltage
	Connection for equipotential bonding

3 Safety

The device has been manufactured according to the state of the art of technology while observing recognised safety-related rules. When using the device, it is nevertheless possible for hazards to occur to life and limb of the user or third parties or for the device, environment or material assets to be compromised.

Only use the device under the following conditions:

- If it is not damaged
- As intended, while remaining aware of safety and hazards
- In accordance with these operating instructions.

3.1 Intended use

The ORCA01 HMIs with the ORCA device platform are Panel-mount devices (PM) and Operator Stations (OS) suitable for industrial production in hazardous areas.

Depending on their version, the devices are certified for the following hazardous areas:

ORCA series	Hazardous area	Directive
E	Zone 1, 2, 21 and 22 (EPL Gb, Db)	ATEX directive, IEC
M	Zone 2 and 22 (EPL Gc, Dc)	ATEX directive, IEC

The ORCA device platform has been developed for process and machine operation in the pharmaceutical, chemical, food, biotech and life science industries. The device can be used indoors as well as in protected outdoor areas.

The approved operating temperature ranges depend on the version:

- Panel-mount device: from -20 °C to +55 °C
- Operator Station: from -20 °C to +50 °C

Depending on their configuration, the following versions with the ORCA device platform are available:

- Panel PC - Thin Clients
- Direct Monitor

The ORCA device platform consists of a display and an E-Box module that are usually installed together. The display module mostly consists of all display components, whereas the E-Box module mostly consists of the other electronic parts.

For service and repair (replacement) purposes the modules can be supplied separately. The conditions listed in chapter [12.4.1 Mounting / dismounting the modules](#) apply.

The ORCA device platform communicates with automation systems and distributed control systems via Ethernet or a serial interface, and has additional USB interfaces for peripherals such as keyboards, pointing devices, RFID readers, barcode readers for material inventory or an EM-STOP button.

A connection box with separate compartments for Ex e and Ex ia circuits is used for the connection of all external cables.

The devices can be mounted into the cut-out of enclosures with IP65 according to IEC 60079-0 or into enclosures with protection type Ex eb or ec, Ex tb or tc, or Ex p. They meet the requirements of each of these enclosures.

"Intended use" includes complying with these operating instructions and other applicable documents, e.g. the data sheet. All other uses are only considered to be intended after being approved by R. STAHL.

3.2 Predictable improper use

The device may only be installed and connected by qualified or specifically trained personnel.

3.3 Personnel qualification

Qualified specialist personnel is required to perform the activities described in these operating instructions. This primarily applies to work in the following areas:

- Product selection and project engineering
- Mounting / dismounting the device
- Installation
- Commissioning
- Maintenance, cleaning

Specialists who perform these tasks must have a level of knowledge that meets applicable national or equivalent country-specific standards and regulations. Additional knowledge is required for any activity in hazardous areas !

R. STAHL recommends having a level of knowledge equal to that described in the following standards:

- IEC/EN 60079-14 (Electrical installations design, selection and erection)
- IEC/EN 60079-17 (Inspection and maintenance of electrical installations)
- IEC/EN 60079-19 (Equipment repair, overhaul and reclamation)

3.4 Special conditions of use

The intrinsically safe circuits are earthed.

The devices (including their connection cables) may only be installed in areas where there are absolutely no intensive electrostatic charge processes.

For ORCA01M* only:

The devices are intended for installation in areas with degree of pollution of at least 2 according to IEC 60664-1.

An overvoltage protector must be fitted that is set to a value of no more than 140 % of the peak value of the nominal voltage at the supply connections of the device.



Please refer to the certificates for more special conditions.

3.5 Residual risks

3.5.1 Explosion hazard

Despite the device's state-of-the-art design, explosion hazards cannot be entirely eliminated in hazardous areas.

- Perform all tasks in hazardous areas with the utmost care at all times !

Possible hazards ("residual risks") can be categorised according to the following causes:

Mechanical damage

The device may become damaged during transport, mounting or commissioning. This kind of damage may, for example, render the device's explosion protection partially or completely ineffective. This may result in explosions causing serious or even fatal injury.

- Do not commission a damaged device.
- Only transport the device in special transport packaging that reliably protects the device from external influences. Take ambient conditions into account when selecting the transport packaging (see chapter [17.1 Technical data](#)).
- Do not place any loads on the device.
- Check the packaging and the device for damage. Immediately report any damage to R. STAHL.
- Store the device ideally in its original packaging in a dry place (with no condensation) and make sure that it is stable and protected against the effects of vibrations and knocks.
- Do not damage the device or seals during its installation.

Excessive heating or electrostatic charge

- Operate the device only within the prescribed operating conditions (see chapters [4.9 Markings on the device](#) and [17.1 Technical data](#)).
- Mount and install the device in such a way that it is always operated within the permissible temperature range.
- Do not use the device in strong charge-generating environments.
- Avoid friction and flow of particle streams.
- R. STAHL recommends you equip devices used outdoors or exposed to the elements with a protective roof or wall.
- Regularly inspect the device for a material change. If you spot any changes, test or replace the device.
- Do not paint or repaint the device yourself. Do not have the paintwork touched up by anyone other than the manufacturer.
- Comply with the area specification of EN/IEC 60079-0 when fitting additional plastic adhesive labels.
- Clean the device with a damp cloth only.
- Do not cover the display with protective foil.

Improper mounting, installation, commissioning, maintenance or cleaning

Basic work such as installation, commissioning, maintenance or cleaning of the device must always be performed in accordance with the applicable national regulations of the country of use and only by qualified persons. Otherwise, the explosion protection may be rendered ineffective. This may result in explosions causing serious or even fatal injury.

- Have the assembly, installation, commissioning and maintenance work performed by qualified and authorised persons only (see chapter [3.3 Personnel qualification](#)).
- Prior to commissioning, check the device is correctly mounted (see chapter [8 Mounting and installation](#)).
- Electrical circuits with Ex i type of protection may no longer be operated as electrical circuits with this type of protection after being operated with electrical circuits with other types of protection.
- Even when used in Zones 2 and 22, intrinsically safe devices of Zones 0, 1, 20 and 21 can be connected to the intrinsically safe signal circuits.
- Only connect the device to equipment which does not carry voltages higher than 250 VAC (50 - 60 Hz).
- Connect Ex i devices only to intrinsically safe terminals.
- In hazardous areas, always switch the electrical circuits and devices to a de-energised state before disconnecting or connecting and when mounting / dismantling.
- Do not change or modify the device.
- Any repair on the device is to be performed by R. STAHL only.
- Gently clean the device with a damp cloth only – do not use scratching, abrasive or aggressive cleaning agents or solutions.
- Never clean the device with a strong water jet, such as a pressure washer !
- The device protection may be compromised if the device is being used outside of its intended purpose as specified by the manufacturer.

3.5.2 Risk of injury

Falling devices or components

The heavy device or components can fall during transport and mounting, causing severe injury to persons in the form of bruises and contusions.

- Use transporting and lifting equipment suitable for the size and weight of the device when transporting and mounting it.
- Observe the weight and the maximum load-bearing capacity of the device; see specifications on the shipping label or on the packaging.
- Use suitable mounting materials for mounting.

Electric shock

During operation and maintenance, high voltage is at times applied to the device. Because of this, the device must be de-energised during installation. Persons coming into contact with electrical lines carrying excessively high voltage can suffer severe electric shocks and, consequently, injuries.

- Only connect electrical circuits to suitable terminals.

3.5.3 Device damage

As a result of unsuitable operating conditions or careless handling the device or individual components may be damaged so significantly that the device does not operate correctly or fails completely.

- Do not subject the device to external heat sources or direct sunshine. Ensure that the maximum ambient temperature is never exceeded.
- Do not open the enclosure. The enclosure has been sealed permanently.

3.6 Industrial Security

Our products with Industrial Security functions support the secure operation of facilities, systems and equipment. Protection against cyber threats requires an all-encompassing Industrial Security concept. The key to a successful concept is integrated implementation, continuous maintenance and state-of-the-art technology. This is the responsibility of the facility operator.

The following are key issues for effective industrial security concepts:

- Prevention of unauthorised access to facilities, systems, equipment and networks
- Systems, equipment and components should only be connected to the company intranet or the internet if and when required
- Employ protective measures such as firewalls and network segmentation
- Only use the latest software product versions
- Carry out software updates as soon as new updates are available
- Use standard user accounts for regular operation
- Use secure passwords
- Appropriate safeguarding of administrator accounts
- Application of security guidelines
- Other measures to be taken as required

R. STAHL uses Windows 10 for its products. The company does not develop any cryptographic functions. Neither does the company create any system configuration / system hardening software, provide security guidelines for these, nor does it refer to any such guidelines.

Moreover, R. STAHL is constantly working on enhancing its products, thereby contributing to system security and to minimizing the risk of cyber threats.

4 Function and device design

4.1 Features and versions

4.1.1 Options

The HMIs with the ORCA device platform are Panel-mount devices (PM) and Operator Stations (OS) that have been developed for process and machine operation in the pharmaceutical, chemical, food, biotech and life science industries.

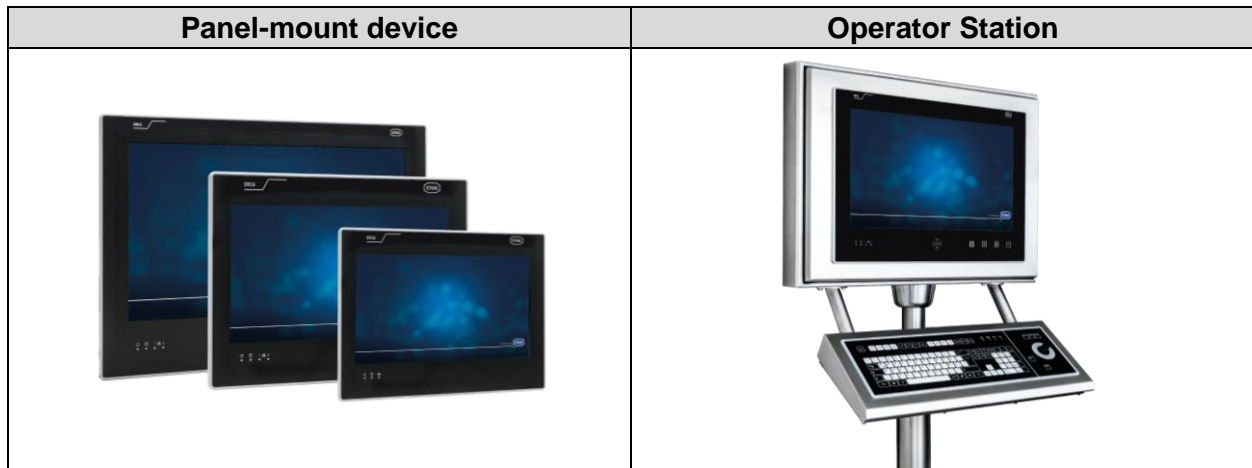

Depending on their technology, the devices perform the following tasks:

Technology	Task
Panel PC / Thin Client	Industrial PC with computer and monitor or Thin Client for remote control of PCs or virtual workstations, for example via Ethernet and WiFi.
Direct Monitor (USB) (only 22" display)	Extension of the primary screen for a dual-screen solution via a USB connection, requiring driver support at the main device.

4.1.2 Panel-mount device

The Panel-mount devices consist of a display box (D-Box) and an electronics box module (E-Box) that are installed together. The display box module mostly consists of all display components, whereas the E-Box module mostly consists of the other electronic parts.

4.1.2.1 D-Box

The ORCA device platform is available with the following types of display:

- Size: 12", 15" or 22"
- Multi-touch function
- Dimmable (via the operating system and, for the 22" model, also via sensor keys)

Optional components:

- Integrated PC/SC card reader (only 22" display)

4.1.2.2 E-Box

Available E-Boxes are:

- E-Box Standard, with
DC supply, Intel® ATOM™ processor, copper Ethernet interface
- E-Box PRO, with
AC or DC supply, Intel® ATOM™ or Intel® Core i5™ processor, optional with two
copper / fibre optic Ethernet interfaces

4.1.2.3 Combination options of D-Box and E-Box

Display size D-Box	E-Box Standard	E-Box PRO
12"	X	-
15"	X	X
22"	X	X
22" (Direct Monitor)	-	X

4.1.3 Operator Station

The 22" Operator Stations are specifically intended for the process industry. This means both the installation in production areas where there is a lot of dirt and pollution, and the installation in class C cleanrooms.

All Operator Stations have a 22" display box and either the E-Box Standard or the E-Box PRO. These Panel-mount devices are installed in a type ORCA-OFR enclosure with GMP-compliant design.

These Operator Stations can be installed as single as well as dual-screen solutions.

Further features of the enclosure:

- Waterproof and dust-tight IP66
- V2A or V4A stainless steel enclosure
- Easily accessible via front door with GMP gasket

Optional components:

- Intrinsically safe KB2 keyboard with trackball, touchpad or joystick
- Prepared for operation of Barcode scanner (pre-wired) (Barcode scanner to be ordered separately)
- On / off button

4.1.3.1 Card reader for access control

As an option, the 22" ORCA01* devices can be fitted with an integrated card reader. This card reader is a proximity reader that can read the corresponding transponder media without direct contact and transfer the data to operating devices or any other systems.

In addition, all ORCA01* devices can be fitted with STAHL's proprietary UB03 card reader via USB. For this, the PM devices have to be installed inside an enclosure.

Three versions of RFID reader are available for different types of data transfer between reader and a corresponding software.

Internal card readers (in D-Box):

- PC/SC - version C8: PC/SC is a platform and manufacturer-independent standard for card readers with access to smartcards. PC/SC stands for "personal computer / smart card". Internally, the module is connected via a USB interface.

External UB03 card reader as accessory (at Operator Station):

- CRYPT - version C5: data is transferred via an encrypted bidirectional protocol. This protocol can also be used to describe the transponder media. The connected device must be able to support the data encryption via a suitable application. The protocol description can be provided once a confidentiality agreement has been signed.
- ASCII - version C6: when the transponder medium approaches the reader or is removed from it, the reader actively sends the pre-parameterised content of the medium in the form of characters transformed byte-wise from hex code to ASCII. Applications such as PM Logon from Siemens or LogOnPlus from i.p.a.s. support this protocol.

4.1.4 Accessories

Peripherals:

- Barcode scanner
- UB03 Card reader
- Attached KB2 keyboard and pointing device (trackball, joystick or touchpad (Ex ia))
- On / off button

The accessories are connected in the connection box (see chapter [4.6 Connection box](#)).



For associated Operating Instructions see r-stahl.com.

4.1.5 Scope of delivery

4.1.5.1 Panel-mount device

- ORCA01* Panel-mount device according to ordered configuration
- Mounting frame including pre-assembled screws
- Cable glands as a set for E-Box Standard or E-Box PRO (depending on Panel-mount device configuration)
- Touch pen
- USB stick (with documentation and image) – cannot be used in hazardous areas
- USB adapter board (for commissioning purposes) – cannot be used in hazardous areas



- Operating Instructions

4.1.5.2 Operator Station

- ORCA01* Operator Station according to ordered configuration, completely wired and ready for operation
- Cable glands as a set for E-Box Standard or E-Box PRO (depending on Operator Station configuration)
- Touch pen
- USB stick (with documentation and image) – cannot be used in hazardous areas
- USB adapter board (for commissioning purposes) – cannot be used in hazardous areas



- Operating Instructions

4.2 Device design

4.2.1 Panel-mount device

Taking the 15" device with E-Box Standard as an example:

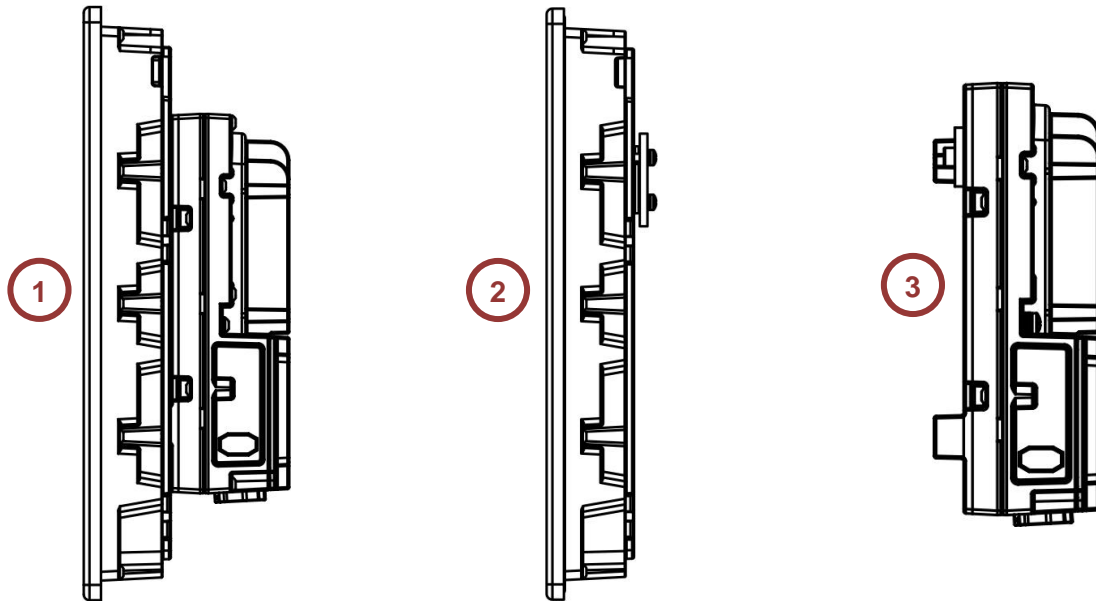

Item	Designation
1	ORCA01* 15" device with E-Box Standard
2	15" display box (D-Box)
3	E-Box Standard

4.3 Type code

4.3.1 Family code

The family code contains all information relevant for certification.

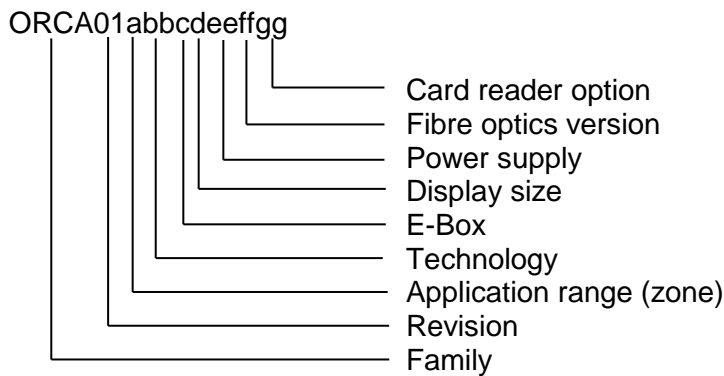

Family code digit	Possible value	Description
ORCA	ORCA	Family designation
01	01	Family hardware revision
a	E	Devices for Zone 1, Zone 21, EPL Gb, Db
	M	Devices for Zone 2, Zone 22, EPL Gc, Dc
	I	Devices for safe areas, Non-Ex
bb	00	No technology
	TC	Thin Client / Panel PC
	DM	Direct Monitor
c	0	no E-Box
	S	E-Box Standard
	P	E-Box PRO
d	0	no display
	3	Display size 3 (12")
	4	Display size 4 (15")
	6	Display size 6 (22")
ee	00	no power supply
	AC	AC power supply
	DC	DC power supply
ff	00	no fibre optic
	MM	multi-mode fibre optic
	SM	single mode fibre optic
gg	00	no card reader
	C8	RFID PC-SC card reader

4.3.2 Type key code field system

Field systems					
Definition Field systems	<p>A field system consists of at least one HMI unit and its integrated software. If the HMI unit is mounted inside an enclosure, this enclosure as well as all other accessories mounted inside it are part of the field system. To facilitate the order-process for a field system, a product code was developed that can reproduce all possible combinations of device, software, enclosure and accessories. This product code consists of alpha-numerical characters and may look as follows: E59A10TT2-C50C3000000221-1012000000000Y This example is valid for a Panel PC / Thin Client system; the product codes for all other field systems are built in the same way.</p>				
	It is decoded as follows:				
Decoding	E59A10TT2	-	C50C3000000221	-	10120000000000Y
Meaning	Device version	Hyphen	extended device version	Hyphen	Enclosure and accessories
	For an exact definition of each individual character please refer to the type code for field systems on the following pages.				
	<p>A field system can only be ordered with a valid and plausible product code. For this, all digits of the product code must be filled with a valid character. Please also note that for technical reasons not all theoretically possible product codes and thus field systems can actually be realised. Should you have any questions in this regard, please contact R. STAHL HMI Systems GmbH.</p>				

Position in type key	Meaning	Possible value	Description
1	Application range (zone)	E	Devices for Zone 1, Zone 21, EPL Gb, Db
		M	Devices for Zone 2, Zone 22, EPL Gc, Dc
2	Technology	0	Display-Box (stand-alone)
		5	Thin Client / Panel PC
		7	Direct Monitor
3	Display size	0	no display, only E-Box (stand-alone)
		2	12" / 30.8 cm display, 1280 x 800 pixels
		4	15" / 39.5 cm display, 1920 x 1080 pixels
		9	22" / 55 cm display, 1920 x 1080 pixels
4	Platform	A	ORCA platform
5	Hardware revision	1	Hardware revision 01.01.01
6	Basic option 1	0	no option
7	Interface medium	0	no interface
		T	1x 1000Base-TX Copper Ethernet
		F	1x 100Base-FX FO Ethernet, multi-mode
		S	1x 1000Base-SX FO Ethernet, multi-mode
		L	1x 1000Base-LX FO Ethernet, single mode
		E	Ethernet extender
8	Interface medium 2	0	no interface
		F	1x 100Base-FX FO Ethernet, multi-mode
		S	1x 1000Base-SX FO Ethernet, multi-mode
		L	1x 1000Base-LX FO Ethernet, single mode
		U	Additional USBc interface

9	E-Box Option	0	no E-Box
		1	E-Box Standard
		2	E-Box PRO
		3	E-Box PRO, Direct Monitor
10	Hyphen	-	Hyphen
11	Processor type	0	no processor
		B	Intel® ATOM™ E3940
		C	Intel® Core i5™ 8365UE
12	Main memory (RAM)	0	no main memory
		3	4 GB (ATOM)
		4	8 GB (ATOM)
		5	16 GB (i5)
		6	32 GB (planned for future)
13	Display type	0	Standard TFT
		1	Sunlight readable (planned for future)
14	Data memory	0	no data memory
		A	64 GB SSD (ATOM)
		9	128 GB SSD (ATOM)
		C	256 GB SSD (i5)
		E	480 GB SSD (planned for future)
15	Touchscreen	0	no touch screen
		3	Projected capacitive (PCAP), multi-touch
16	Power supply	N	no power supply
		0	DC power supply 24 VDC
		1	AC power supply 85 - 250 VAC
17	Optional Interfaces 1 (WiFi, Bluetooth)	0	no WiFi, no Bluetooth
18	Optional Interfaces 2 (internal card reader)	0	no card reader
		8	RFID card reader PC-SC
19	Optional Interfaces 3 (Audio)	0	no audio
		1	USBc interface
		5	Audio amplifier output
20	additional options	0	no additional option
21	Front design	0	Standard
22	Front plate special version	0	no front plate
		1	neutral
		2	STAHL
23	Operating system	0	No operating system
		1	WIN10 IoT Enterprise 2019 LTSC 32Bit
		2	WIN10 IoT Enterprise 2019 LTSC 64Bit
		3	PXE-Boot (for ThinManager)
		4	IGEL OS 11 (does not include license)

24	Image	0	no image
		1	OS STAHL
		3	Remote V6 STAHL
		5	Movicon Power HMI 2048
		6	IGEL OS 11
25	Hyphen	-	Hyphen
26	Enclosure version	0	no enclosure, no options
		1	ORCA-OFR Operator Station (22" device only)
		2	ORCA FR Operator Station
		3	ORCA CFR Operator Station
27	Enclosure option	0	no enclosure option - standard
		1	SL (Slim) enclosure (reduced enclosure depth – for 12" and 15" devices only)
28	Enclosure material	0	no enclosure material
		1	V2A SS304 stainless steel
		2	V4A SS316L stainless steel
29	Enclosure mounting type	0	no enclosure mounting
		1	Wall mounting
		2	Mounted on stand or elbow below
		3	Mounted at ceiling or elbow on top
30	Outdoor Installation	0	no outdoor installation – indoor only
		3	Protected outdoor area (breather available)
31	Keyboard (layout)	0	no keyboard, no keyboard enclosure
		D	Keyboard in keyboard enclosure with keyboard layout German - DE (QWERTZ)
		E	Keyboard in keyboard enclosure with keyboard layout American - US (QWERTY)
		F	Keyboard in keyboard enclosure with keyboard layout French - FR (AZERTY)
		G	Keyboard in keyboard enclosure with keyboard layout Swiss German - CH
		H	Keyboard in keyboard enclosure with keyboard layout Spanish - ES
		I	Keyboard in keyboard enclosure with keyboard layout Slovenian - SL
		J	Keyboard in keyboard enclosure with keyboard layout Japanese - JP
		K	Keyboard in keyboard enclosure with keyboard layout Nordic (Swedish, Finnish, Norwegian, Danish)
		U	Keyboard in keyboard enclosure with keyboard layout Hungarian - HU
B	Keyboard matrix		

32	Integrated pointing device	0	no integrated pointing device in keyboard enclosure
		1	IP68 trackball in keyboard enclosure
		4	Touchpad in keyboard enclosure
		5	Joystick in keyboard enclosure
33	Optionale devices 1	0	no optional devices
34	Readers 1 (versions)	0	no reader 1
		5	UB03-xxx-C05-USB (CRYPT) card reader
		6	UB03-xxx-C06-USB (ASCII) card reader
35	Readers 1 (position)	0	no reader 1
		1	Reader in enclosure, right-hand side
		2	Reader in enclosure, left-hand side
		3	Reader at keyboard enclosure, right-hand side
36	Control devices	0	no control device
		1	EM-STOP in enclosure, right-hand side
		2	EM-STOP in enclosure, left-hand side
		3	EM-STOP in enclosure, front side, middle, bottom
37	Readers 2 (versions)	0	no reader 2
		1	Wired barcode scanner (BCR-IDM x6x) (with VM125-ex power supply)
		2	Bluetooth barcode scanner (BCR-IDMBT x6x) (with VM125-ex power supply)
		3	Wired 2D barcode scanner (BCR-IDM 26x) (with VM125-ex power supply)
		4	Bluetooth 2D barcode scanner (BCR-IDM 26x) (with VM125-ex power supply)
38	Readers 2 (position)	0	no reader 2
		1	Reader at enclosure, right-hand side
		2	Reader at enclosure, left-hand side
		3	Reader at keyboard enclosure
39	Further options (inside enclosure)	0	no further options inside enclosure
		1	Y-Purged with barrier (FR, CFR enclosures)
		2	USB Plug downwards (FR, CFR enclosure)
40	Other markings	Y	Marking for new field system code
		L	Marking for loan device
		Z	Marking for field system with document drawing number
		S	Marking for field system fitted with replacement parts

4.4 Available configuration versions

Variant	E-Box	Power supply	Processor type	Main memory	Data memory	Ethernet / Data
E52A M52A	Standard	24 VDC	ATOM E3940	up to 16 GB	up to 256 GB	10/100/1000Base-TX
E54A M54A	Standard	24 VDC	ATOM E3940	up to 16 GB	up to 256 GB	10/100/1000Base-TX
	PRO	24 VDC or 230 VAC	ATOM E3940 or Intel Core i5	up to 16 GB	up to 256 GB	10/100/1000Base-TX
						2x 10/100/1000Base-TX
						10/100/1000Base-TX + 1x 100Base-FX
						10/100/1000Base-TX + 2x 1000Base-SX
10/100/1000Base-TX + 2x 1000Base-LX						
E54A M54A	Standard	24 VDC	ATOM E3940	up to 16 GB	up to 256 GB	10/100/1000Base-TX
	PRO	24 VDC or 230 VAC	ATOM E3940 or Intel Core i5	up to 16 GB	up to 256 GB	10/100/1000Base-TX
						2x 10/100/1000Base-TX
						10/100/1000Base-TX + 1x 100Base-FX
						10/100/1000Base-TX + 2x 1000Base-SX
10/100/1000Base-TX + 2x 1000Base-LX						
E79A M79A	PRO	24 VDC or 230 VAC	-	-	-	-

4.5 Dimensions

4.5.1 Panel-mount devices

4.5.1.1 Front

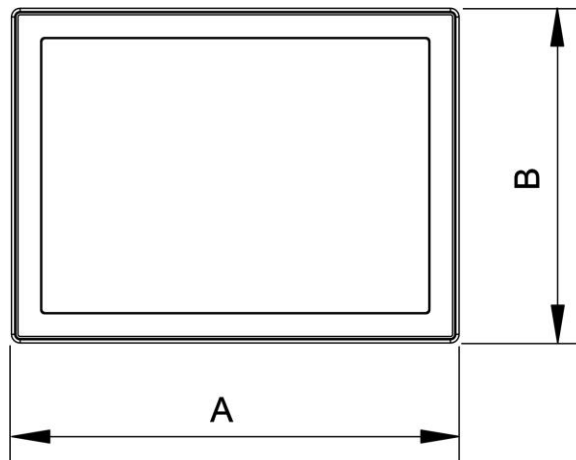

Dimensions (mm)			
Item	E/Mx2A	E/Mx4A	E/Mx9A
A	330	415	565
B	241	310	400

4.5.1.2 Side

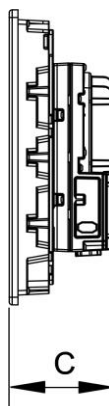

Dimensions (mm)			
Item	E/Mx2A	E/Mx4A / E/Mx9A with E-Box Standard	E/Mx4A / E/Mx9A with E-Box PRO
C	101	108	117

4.5.1.3 Cutout

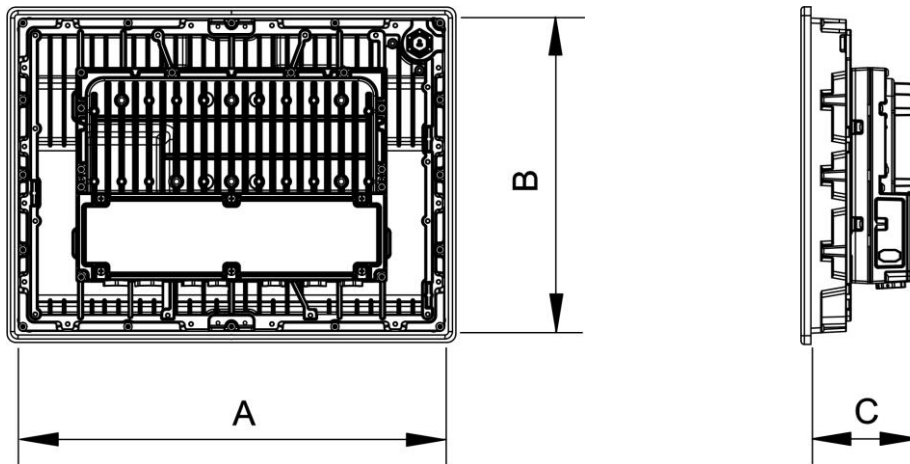

Dimensions (mm)					
Item	E/Mx2A	E/Mx4A with E-Box Standard	E/Mx4A with E-Box PRO	E/Mx9A with E-Box Standard	E/Mx9A with E-Box PRO
A	310	396		547	
B	221	291		382	
C	92	98	108	99	108
Cut-out tolerances [mm]					
	+1.0 mm / -0.5 mm			+-0.5 mm	

4.5.2 ORCA-OFR Operator Station

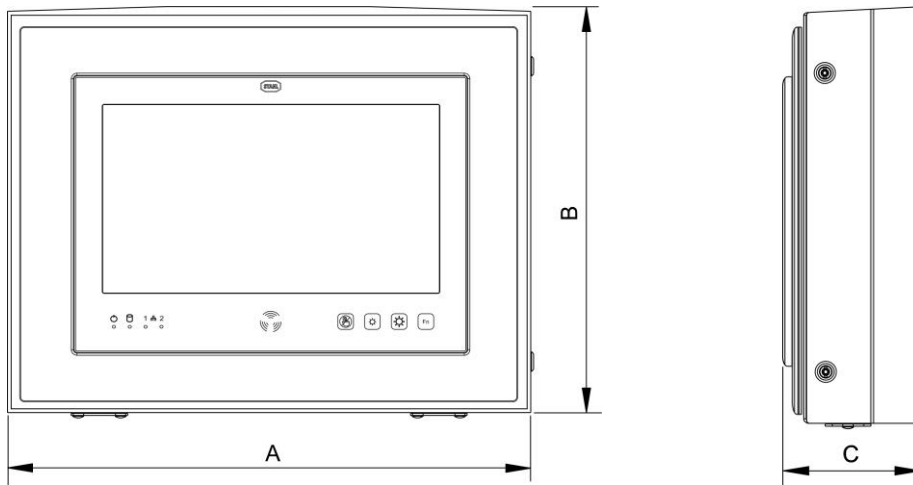

Dimensions (mm)		
A	B	C
708	524	176

4.5.3 ORCA-OFR Operator Station with keyboard

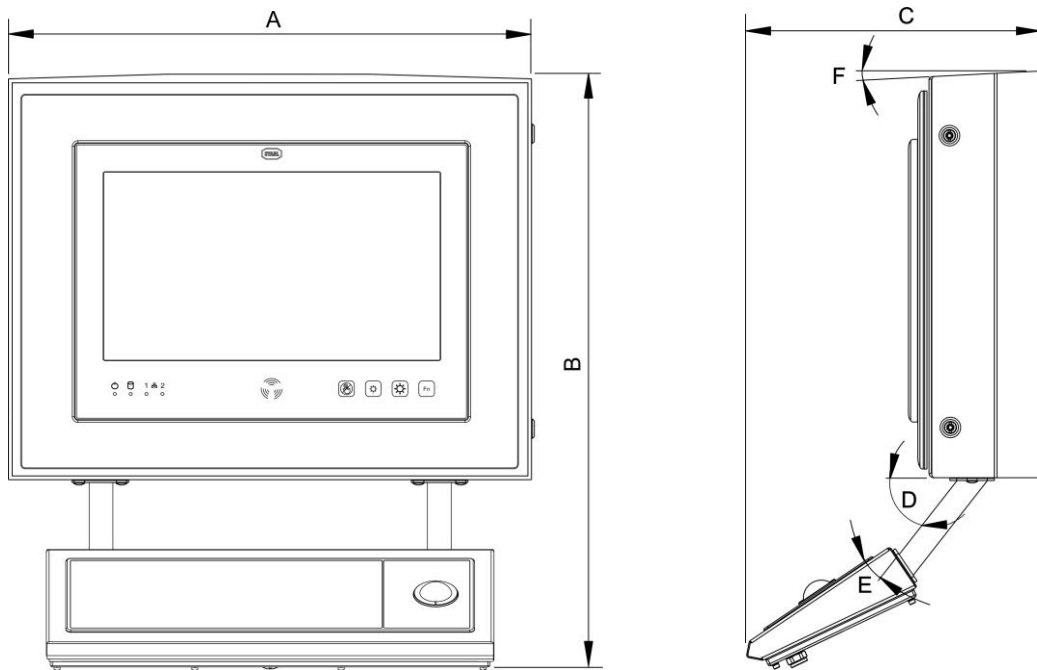

Dimensions (mm)					
A	B	C	D	E	F
708	794	404	52°	18°	5°

4.6 Connection box

4.6.1 E-Box Standard

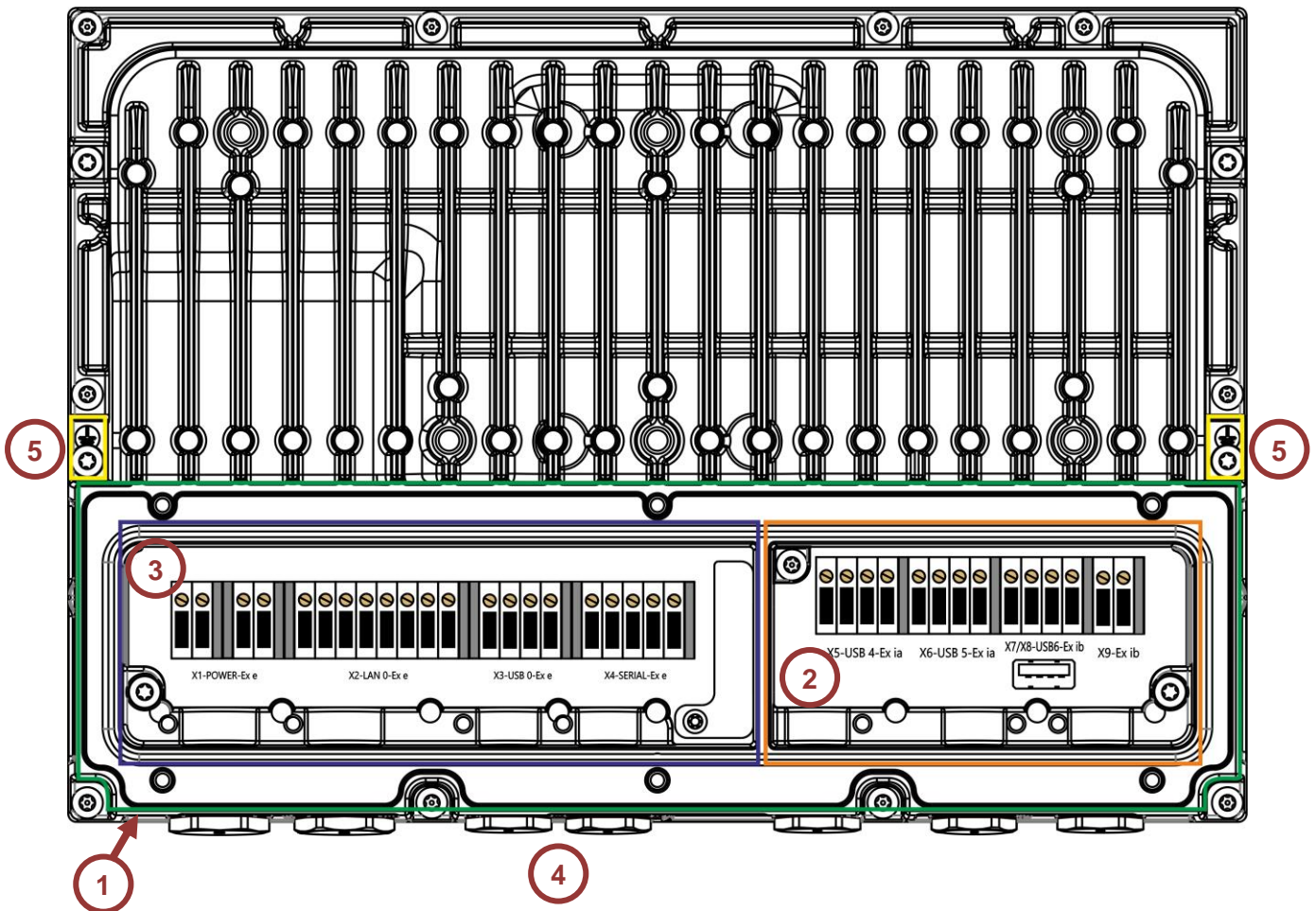

Item	Designation
1	Cover of connection box (removed in picture, circled in green)
2	Ex i Connection terminals (circled in orange)
3	Ex e Connection terminals (circled in blue)
4	Screws plugs (picture shows delivery status)
5	M4 Ground connections

 Cable glands (number, size, etc.) see [17.3 Cable glands](#)

4.6.2 E-Box PRO

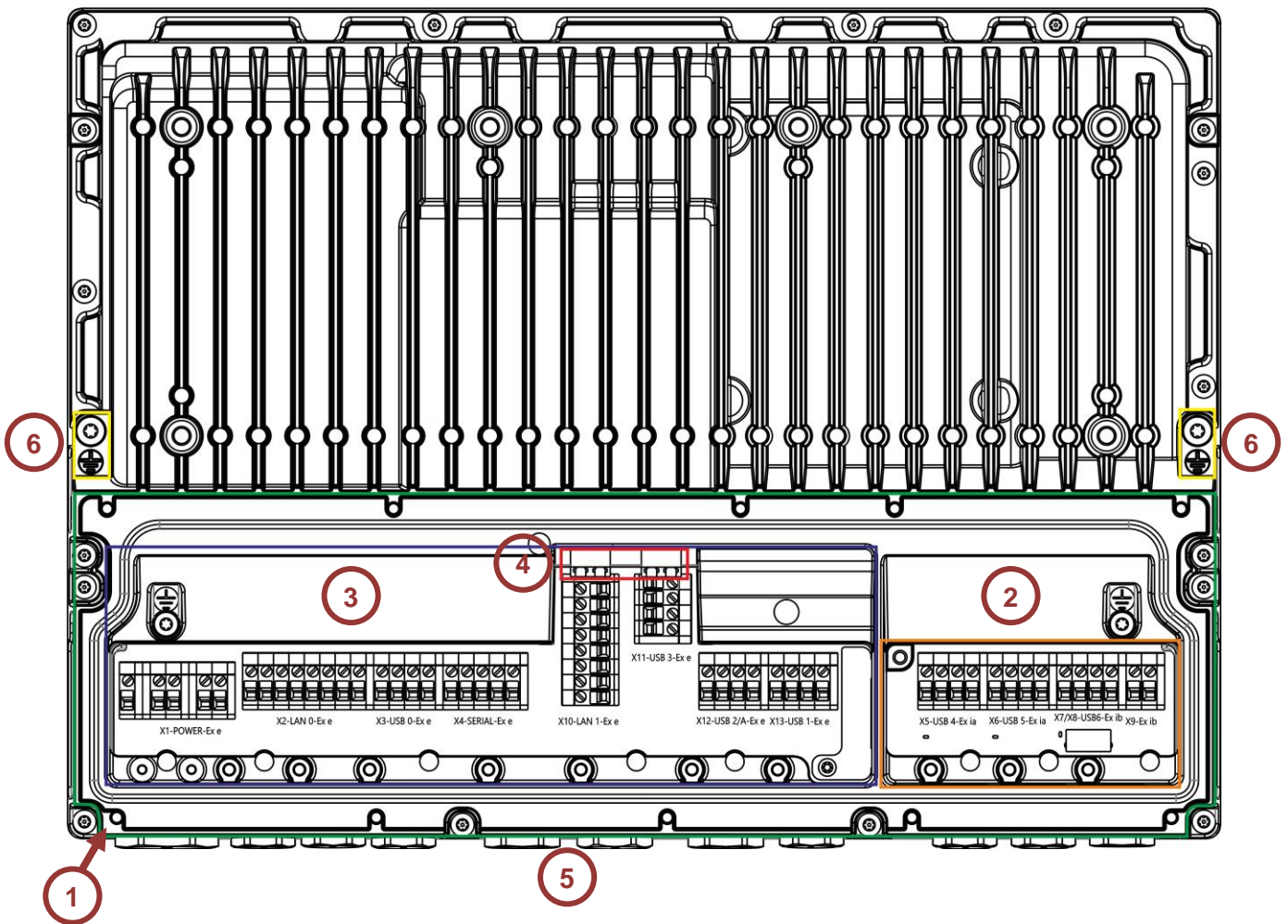

Item	Designation
1	Cover of connection box (removed in picture, circled in green)
2	Ex i Connection terminals (circled in orange)
3	Ex e Connection terminals (circled in blue)
4	Fibre optic connectors (optional) (circled in red)
5	Cable glands (picture shows delivery status)
6	M5 Ground connections



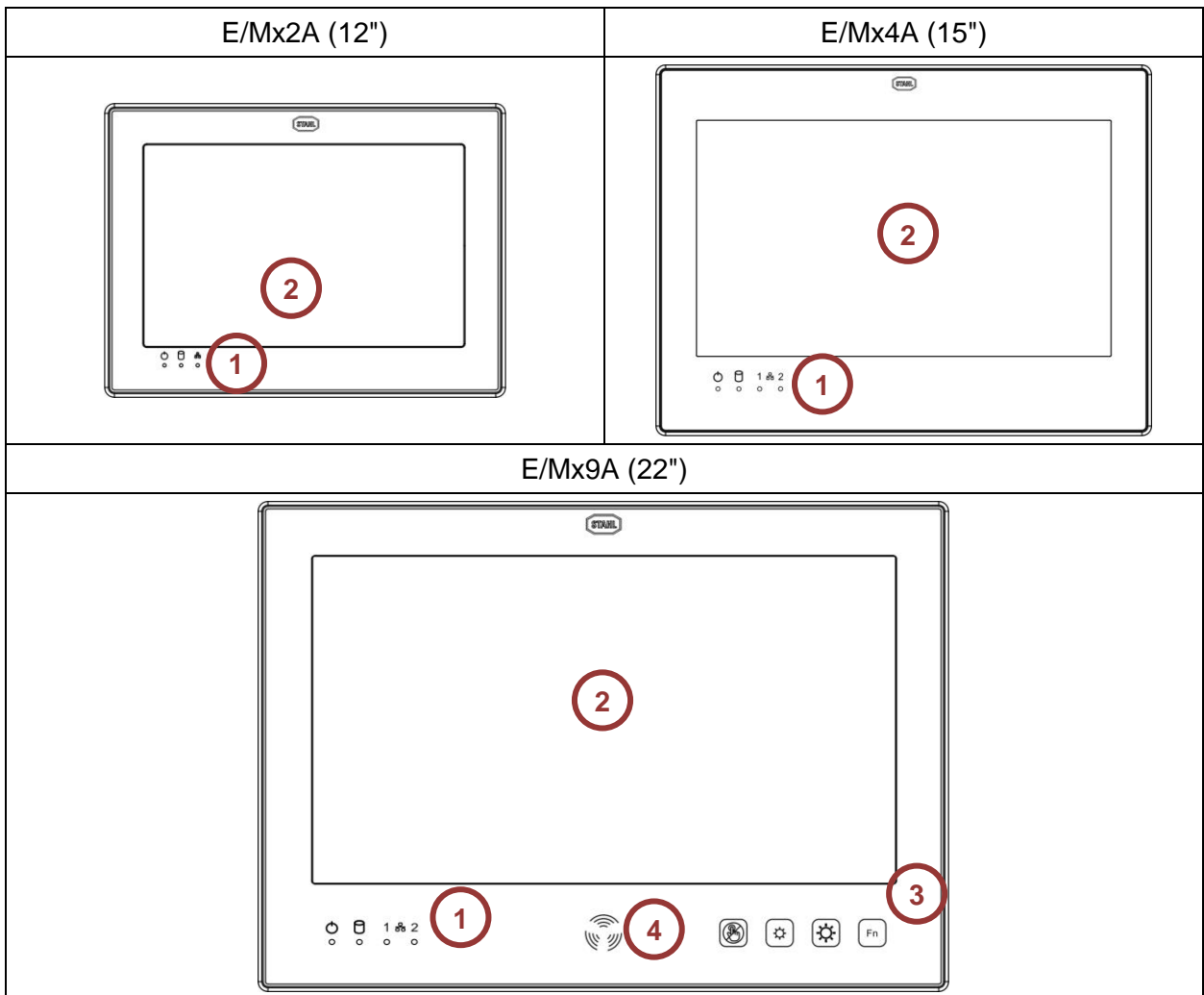

 Cable glands (number, size, etc.) see [17.3 Cable glands](#)

4.7 Operating elements











Item	Designation
1	LEDs
2	Display
3	Sensors 1 to 4
4	RFID card reader (optional)

4.7.1 Sensors

Pictogram	Meaning	Description
	Disable touch	Disables the touch function of the device. Press key for 2 seconds. Key lights up orange when touch is deactivated.
	Brightness adjustment	"Darker" key to reduce the backlight brightness
	Brightness adjustment	"Brighter" key to increase the backlight brightness
	Function key	Freely assignable function key. Set as F8 as standard.

 The keys briefly light up when pressed.

4.8 LED status display

Pictogram	LED colour	Status	Meaning
	 orange	lit	Device is live. Internal power supply ok. Device switched off.
	 white		HMI device in operation.
	 white	flashing	Accessing system disk (Solid State, HDD)
 or 1  2	 white *	off	no connection / no activity at Ethernet port
		lit	Existing connection at Ethernet port
		flashing	Activity at Ethernet port

 If the device contains both FO interfaces (modules), the LEDs will show the activity at the FO Ethernet ports.
There will be no display for the onboard copper interface.

4.9 Markings on the device

4.9.1 Position

4.9.1.1 Field system label

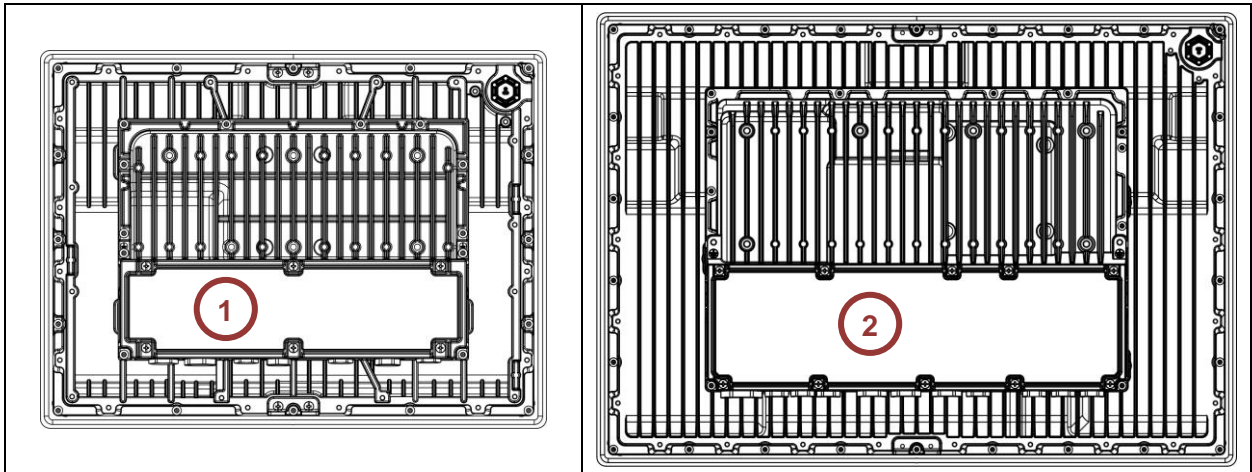

Item	Designation
1	Two-part PM field system type plate on E-Box Standard
2	Three-part PM field system type plate on E-Box PRO

4.9.1.2 Label on E-Boxes

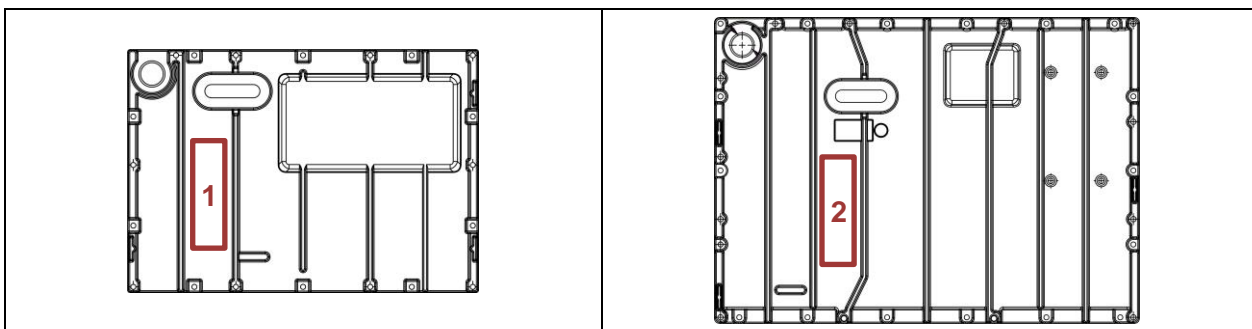

Item	Designation
1	Label on inside of E-Box Standard
2	Label on inside of E-Box PRO

4.9.1.3 Label on display boxes

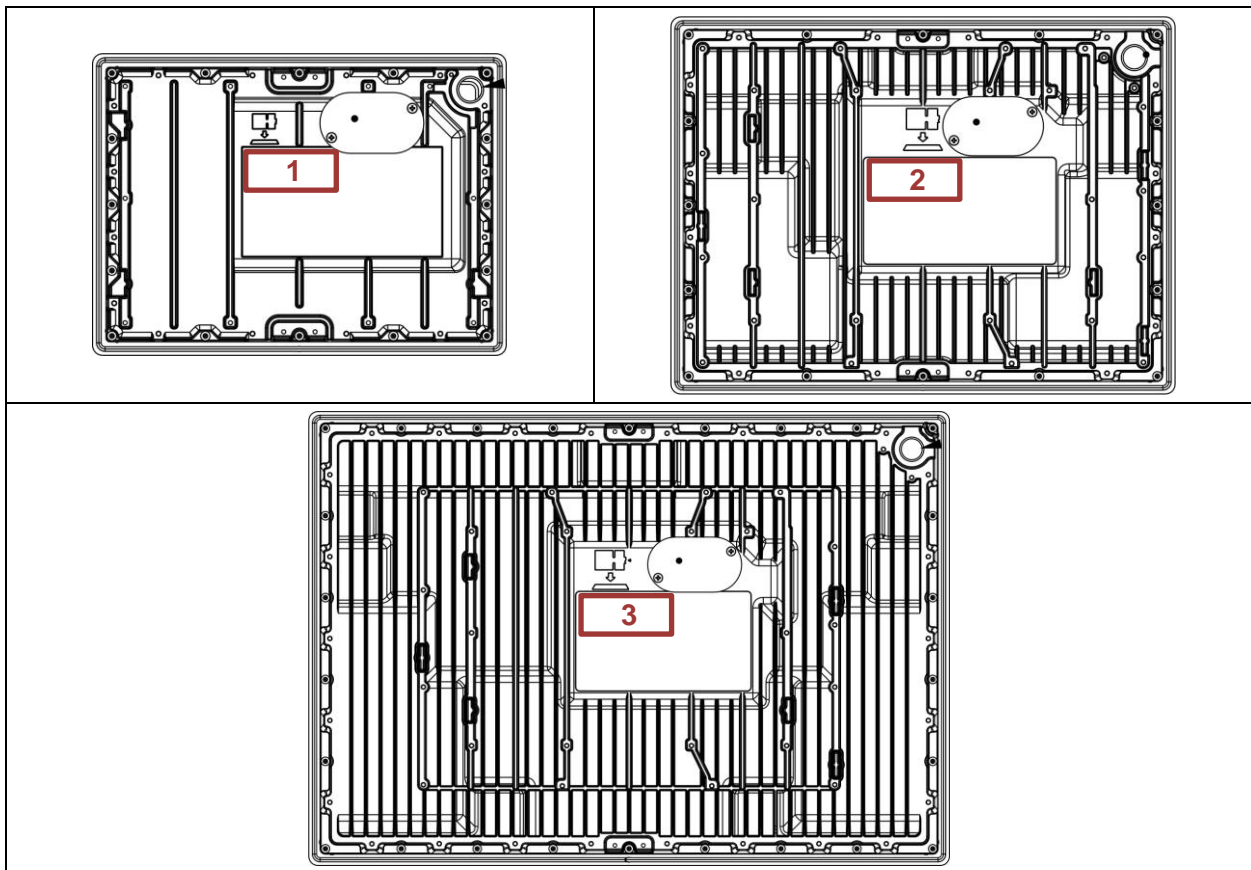

Item	Designation
1	Label on back of 12" display box
2	Label on back of 15" display box
3	Label on back of 22" display box

4.9.1.4 Warning label

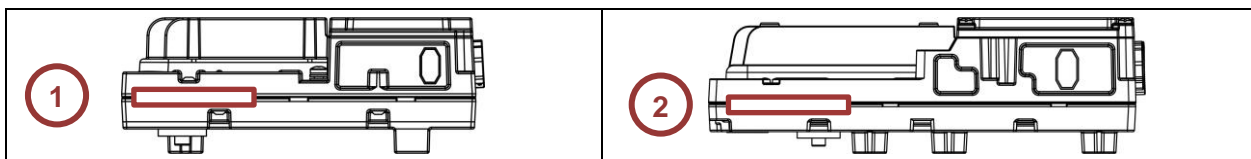

Item	Designation
1	Warning label on E-Box Standard, both sides, multilingual
2	Warning label on E-Box PRO, both sides, multilingual

 Text of warning label for DE and EN:
 Nicht öffnen. Dieses Gehäuse wurde dauerhaft verschlossen und kann nicht repariert werden. Warnhinweis – nicht in einem Bereich öffnen, warten oder Instand setzen, in dem eine explosionsfähige Atmosphäre vorhanden sein kann.
 Do not open. This container has been permanently sealed and cannot be repaired.
 Warning – Do not open, maintain or service in an area where an explosive atmosphere may be present.

4.9.1.5 Safety label

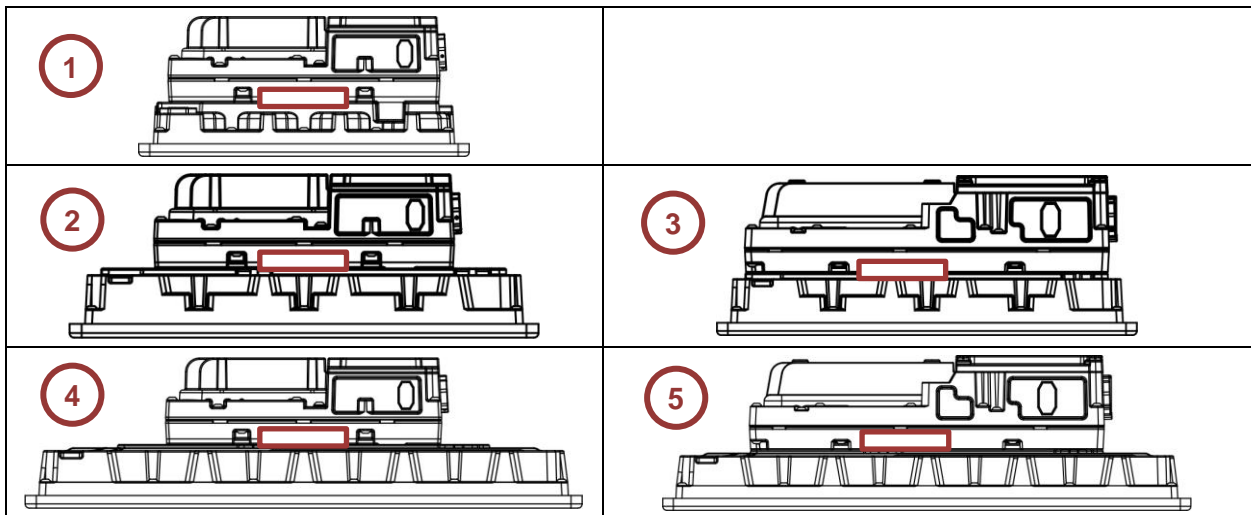

Item	Designation
1	Safety label across E-Box and display box for 12" device with E-Box Standard
2	Safety label across E-Box and display box for 15" device with E-Box Standard
3	Safety label across E-Box and display box for 15" device with E-Box PRO
4	Safety label across E-Box and display box for 22" device with E-Box Standard
5	Safety label across E-Box and display box for 22" device with E-Box PRO

4.9.2 Design of label / type plate

4.9.2.1 Field system label / type plate

View of E-Box Standard label as an example

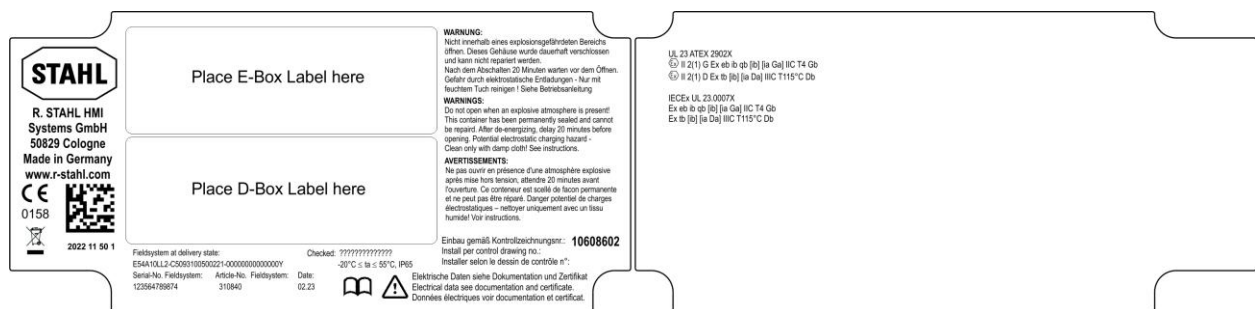

View of E-Box PRO label as an example

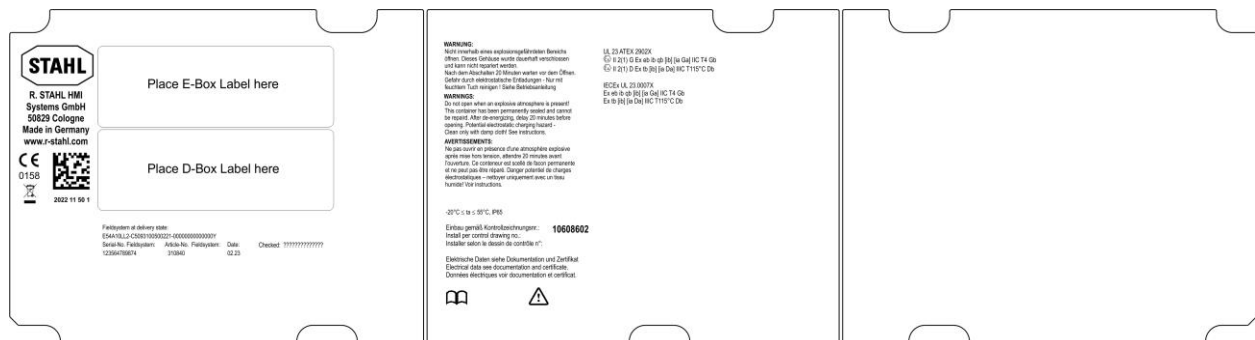

Type plate section:

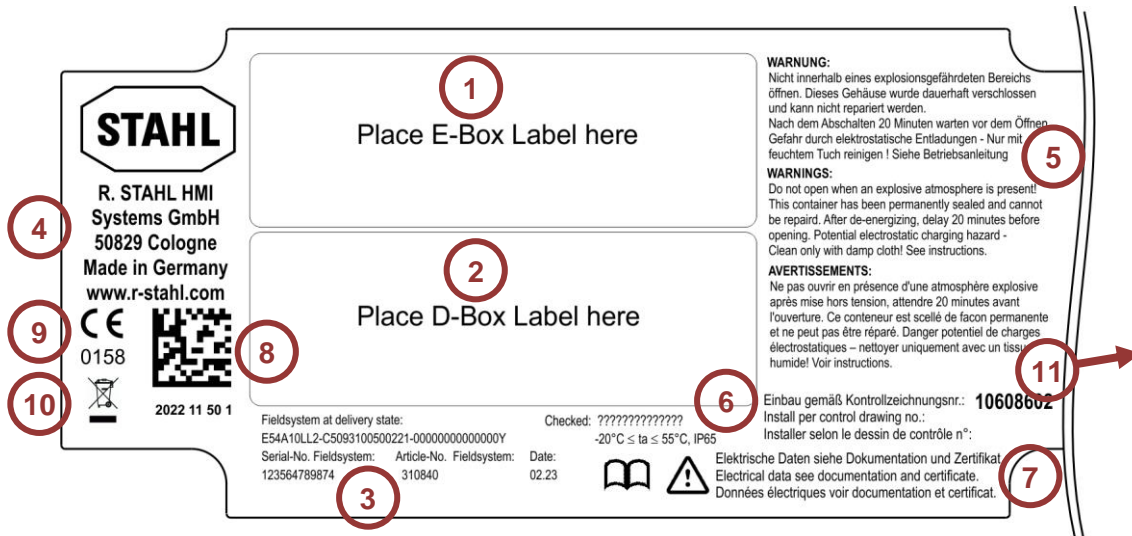

Item	Designation
1	Area of E-Box label
2	Area of D-Box label
3	Data of field system with serial and article number of E-Box and date of manufacture
4	Address of manufacturer
5	Warning notes
6	Temperature range and IP
7	Other information and reference to documentation
8	QR code
9	CE marking
10	Marking according to WEEE directive 2012/19/EU
11	Space for further markings

4.9.2.2 E-Box Label

Example view of an E-Box label

Label on E-Box	Label for E-Box on type plate
<p>ORCA01E0003000000 2022 36 50 0 E02A10000-00003N00000200-00000000000000Y</p> <p>Article-No. D-Box: 294338 Serial-No. D-Box: X47110815X</p> <p>Date: 02.23 Checked: 01.01.01 Name</p> <p>STRAHL R. STAHL HMI Systems GmbH 50829 Cologne Made in Germany www.r-stahl.com</p>	<p>ORCA01EDMP0DC0000</p> <p>Article-No. E-Box: 356897 Serial-No. E-Box: X47110815X Date: 02.23</p> <p>Rated Voltage Range: xx-xx Vxx Rated Current: xx A Rated Frequency: xx-xx Hz</p>

Explanation: see table "Key to E-Box and D-Box labels"

4.9.2.3 D-Box Label

Example view of a D-Box label:

Label on D-Box	Label for D-Box on type plate
<p>ORCA01E0003000000 2022 36 50 0 E02A10000-00003N00000200-00000000000000Y</p> <p>Article-No. D-Box: 294338 Serial-No. D-Box: X47110815X</p> <p>Date: 02.23 Checked: 01.01.01 Name</p> <p>STRAHL R. STAHL HMI Systems GmbH 50829 Cologne Made in Germany www.r-stahl.com</p>	<p>ORCA01E0003000000</p> <p>Article-No. D-Box: 294338 Serial-No. D-Box: X47110815X Date: 02.23</p>

4.9.2.4 Key to E-Box and D-Box labels

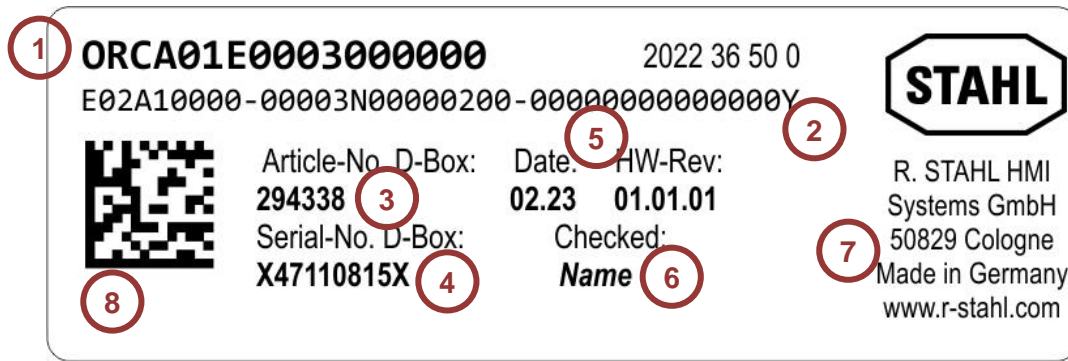

Item	Designation
1	Box family code
2	Box type key code
3	Box article number
4	Box serial number
5	Box manufacture date and hardware revision
6	Name of testing body
7	Address of manufacturer
8	QR code
9	Rated values on E-Box label on type plate

4.10 Ex marking

4.10.1 ATEX / IECEx

Ex marking ATEX / IECEx according to IEC 60079-0 and ATEX directive 2014/34/EU.

ORCA01E* HMI series

Version	2014/34/EU prefix	Ex marking
Gas	⊕ II 2(1) G	Ex eb ib qb [ib] [ja Ga] IIC T4 Gb
Dust	⊕ II 2(1) D	Ex tb [ib] [ja Da] IIIC T115°C Db

ORCA01M*HMI series

Version	2014/34/EU prefix	Ex marking
Gas	⊕ II 3(1) G	Ex ec ib qb [ib Gb] [ja Ga] IIC T4 Gc
Dust	⊕ II 3(1) D	Ex tc [ib Db] [ja Da] IIIC T115°C Dc

5 Operating systems and drivers

5.1 Windows® 10 IoT Enterprise 2019 LTSC operating system

The operating system is based on Windows 10 for PC platforms with 64 bit x86 processors. For the LTSC (Long-Time-Service-Channel) versions, Microsoft guarantees 10 years of security updates and new builds with feature updates only every 2-3 years, with these being optional. The LTSC versions are ideal for industrial applications and feature additional security components such as write filters (UWF) and HORM (start of a system snapshot from the RAM plus write protection)..

From 2016 LTSC onwards, Microsoft has tied its licensing model to the processor performance:

ENTRY for AMD® GX and ATOM™

VALUE for Intel® Core i5™

HIGH for Intel® Core i7™

The license for the Windows 10 IoT Enterprise 2019 LTSC operating system is included in the image. When delivered, the devices have already been registered and activated.

The EOL (End of Life) date for Windows 10 IoT Enterprise 2019 LTSC for support and updates has been set by Microsoft to 09.01.2029.

5.1.1 Recovery



If a Panel PC is reset to the factory state (recovered) it will remain registered and will have to be reactivated. This requires an active internet connection to a Microsoft server.

5.1.2 Proprietary Windows installations and drivers



The Windows 10 IoT license key is tied to STAHL images. The installation of own Windows 10 operating systems requires a separate license key. All necessary drivers are provided by R. STAHL HMI Systems GmbH. Please contact our Support department.

5.2 Data back-up

5.2.1 Recovery Stick



A recovery stick is required to restore the Panel PC devices to their factory state. This recovery stick (USB-drive, also available as an intrinsically safe version) contains the factory image, with which the system can be restored to delivery status within a very short time.

You can restore the HMI devices to their factory state only with the aid of this recovery stick. As an option, the recovery stick can also contain a backup software, with which you can back up your own device configuration.

5.2.2 Back-up

It is the sole responsibility of the operator to generate a back-up of the HMI devices and their overall function.

- Any back-ups generated of the HMI devices must always be stored on external storage media.

5.2.3 Switching off / closing down



The Microsoft Windows operating system stores key data in the main memory, regardless of the application, and has to store this data on the hard disk before the HMI device is switched off. It is therefore important for the safe and correct operation that the HMI device is "shut down" properly and not simply switched off.

Otherwise the existing image of the HMI device may be damaged, rendering the device non-functioning. After the data has been stored, Windows informs the user that the HMI device can now be switched off.

5.2.4 Loss of data

- In the case of applications that require constant writing into memory, R. STAHL HMI Systems GmbH recommends you use external storage media (USB sticks, network servers) for these write processes.
- Avoid cyclical writes (log files, databases, etc.) to the SSD.

The endurance of an SSD depends on the number of write cycles (TBW / terabytes written). Writing to the SSD with a simultaneous drop in voltage is most likely going to result in data loss.

5.3 License sticker

The license sticker for the Windows 10 Ultimate operating system is located on the side of the E-Box.

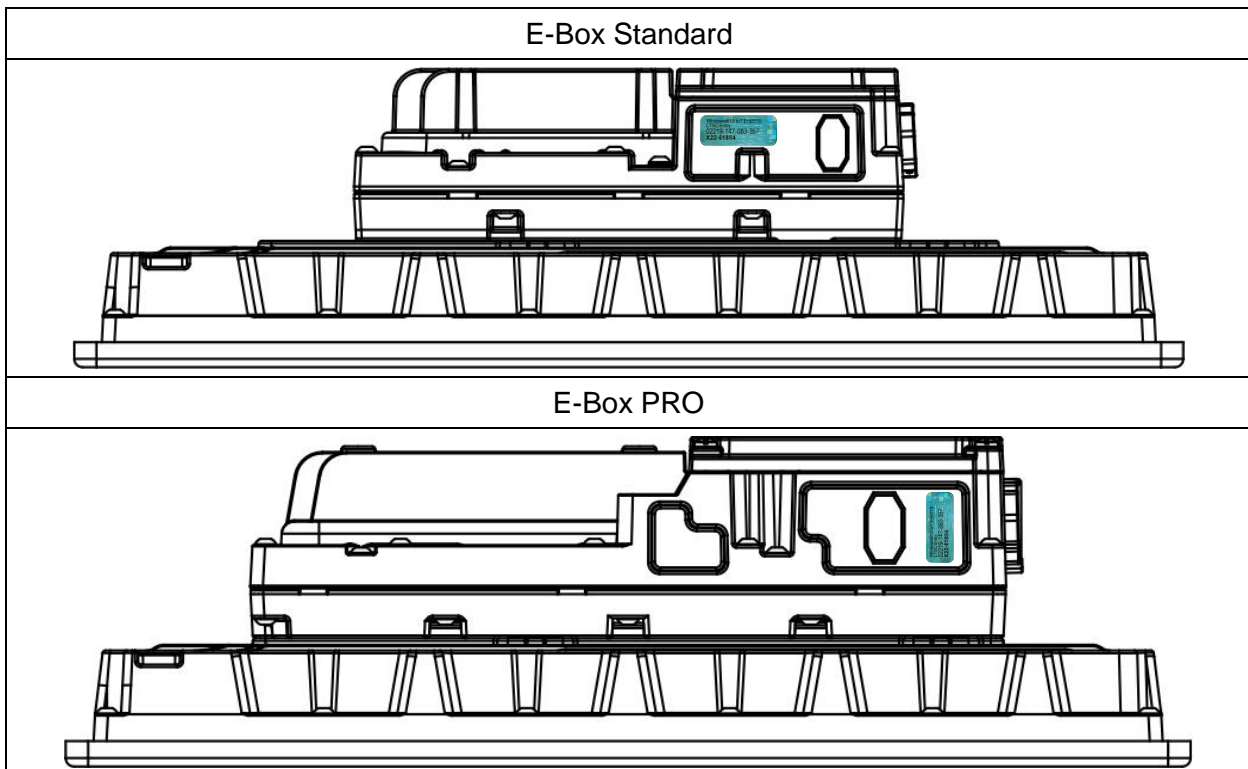

5.4 UPDD touch driver

The UPDD touch driver is a copyrighted, licensed software for the exclusive use with R. STAHL HMI Systems GmbH touch systems.

- Do not load this driver on or use with other devices.

6 Transport and storage

NOTE	<p>Missing or damaged packaging during transport and storage</p> <p>If the device is transported or stored without packaging, shocks, vibrations, pressure and humidity can directly impact the device. Damaged packaging indicates that the device has been subjected to and possibly been damaged by outside influences. This may result in faulty functionality.</p> <ul style="list-style-type: none">• Check the state of the packaging.• Report any damage sustained in transport to the haulier responsible and have it confirmed.• Transport and store the device in undamaged packaging, ideally the original packaging.
-------------	--

- Transport and store the device carefully and in accordance with the safety notes (see chapter [3 Safety](#)).
- Transport and store the device in undamaged packaging, ideally the original packaging.
- Ensure specified storage temperature range is not exceeded (see chapter [17.1.4 Ambient conditions](#)).
- Store the device in a dry place free of vibrations.
- Do not drop the device.

7 Unpacking

- Unpack the device at its final destination.
- Check against the delivery note that the contents are complete and undamaged.
- Contact the manufacturer if the contents are incomplete, damaged or not what you have ordered.
- Dispose of the packaging materials according to local regulations.

8 Mounting and installation

8.1 Note on mounting and installation

Observing the following points will ensure a professional and safe assembly and installation

- Only use threads or holes already present in the enclosure.
- Mount the device carefully and strictly in accordance with the safety notes (see chapter [3 Safety](#)).
- Study the installation conditions and assembly instructions in these operating instructions carefully and follow them to the letter.
- Completely close the ORCA-OFR enclosure (to the second stop) to ensure IP tightness (seal) !
- The devices may only be installed and operated in an undamaged, dry and clean condition ! Any damage may compromise the explosion protection !
- National assembly and installation rules and the generally accepted rules of technology must be observed. The device and its accessories must be installed and operated according to applicable standards, directives and installation guidelines.
- Only use suitable tools for the installation.
- Do not open the connection box when live.
- Disconnect the device from supply before separating E-Box and D-Box for servicing.
- Tightening torque for connection box screws: 3.5 to 3.7 Nm. Tightening torque for mounting of E-Box and D-Box (for servicing): 3.5 to 3.7 Nm.
- Installation according to Control Drawing 10608602.
- The devices are delivered with screw plugs. Before installation, mount the required cable glands on the device.

8.2 Requirements for site of installation



Mount and install the device in such a way that it is always operated within the permissible temperature range.

- Observe the stipulated hazardous zones: ORCA01M* devices may only be installed in Zone 2 and Zone 22.
- The site of installation must be stable and suitable for the dimensions of the device, and able to bear the load of its weight and that of any necessary attachments.
- Ambient temperature: $-20\text{ °C} \leq T_a \leq +55\text{ °C}$ (for Panel-mount device, at OFR $+50\text{ °C}$) at place of installation. Relative humidity 90 % at $+40\text{ °C}$, non-condensing. Outdoor installation permitted up to a height of 2,000 m. Ex-enclosure protection type IP65. The device may be installed and operated in any position.
- Electric parameters of a maximum of 250 V / 17 A must be guaranteed at the place of location.
- In the case of AC models: install an easily accessible disconnection mechanism outside of the device, which can be used to interrupt all conducting wires but not the protective conductor.
- Avoid touch screen contamination by saltwater: conductive liquids on the touch display can result in incorrect or phantom operations. This applies in particular to salt water.

- Protect the device against rain, snow and splashes: excessive amounts of standing or running water will disrupt operation and may cause erratic cursor movement. This protection can be achieved by using a canopy or some other protective roof-type construction. Offshore, strong winds, saltwater and rain will have to also be taken into consideration.

8.3 Mounting types

The device may be installed and operated in any position. R. STAHL recommends the following types of mounting:

Panel mount, wall mounting, mounting on stand / elbow.

8.4 Front installation

The ORCA device platform Panel-mount devices can be mounted inside an enclosure with suitable cut-out with the aid of a fixing frame. This type of mounting is approved for installation in Ex e, Ex p or Ex tb enclosures.

A 20 mbar excess pressure was tested for Ex p applications.

The fixing frame is used to fix the device inside the cover cut-out of the enclosure. It is mounted from the back.

Tightening torque	
Fixing frame screws	3.5 to 3.7 Nm

8.4.1 Panel-mount – installation

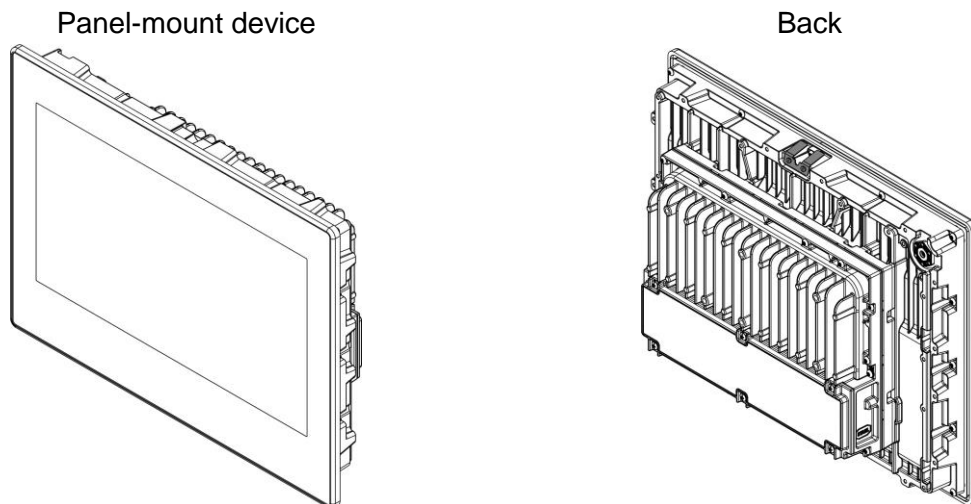

The devices are delivered with screw plugs. Before installation, mount the required cable glands on the device.

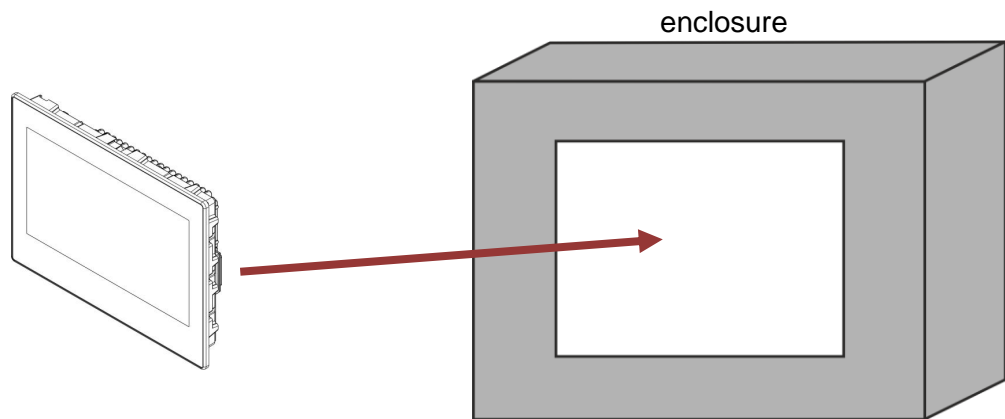
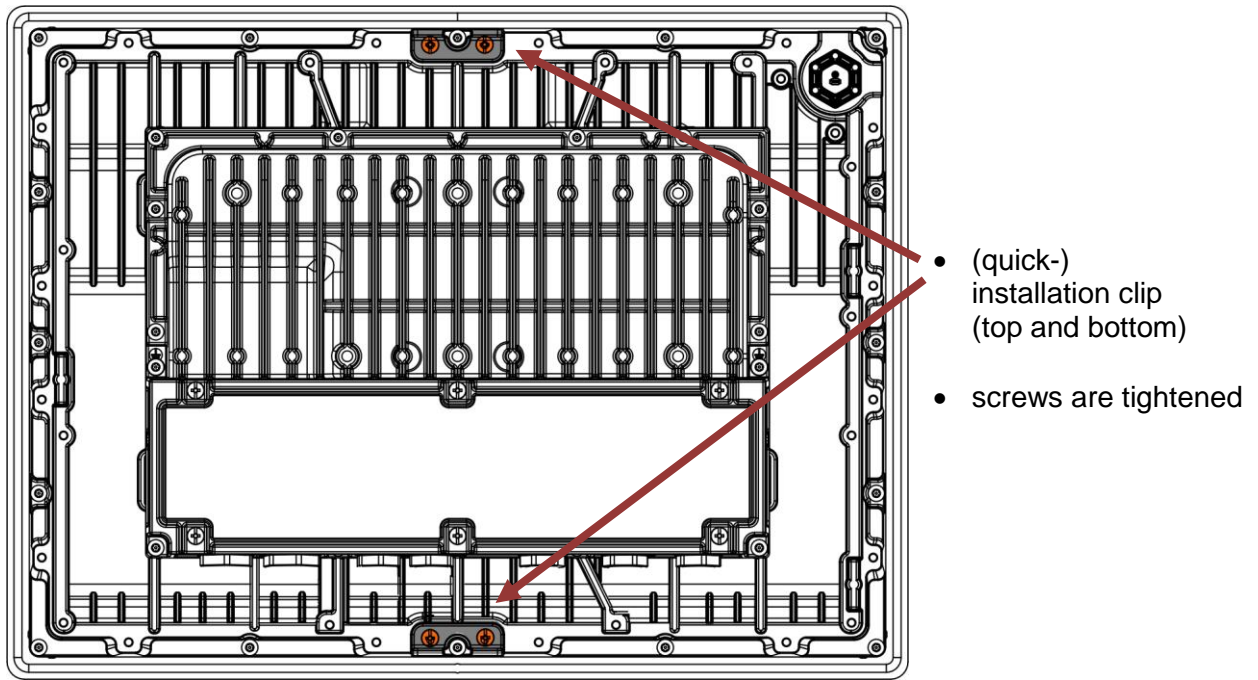

 For dimensions of mounting cut-out of enclosure, see chapter [4.5.1.3 cutout](#)

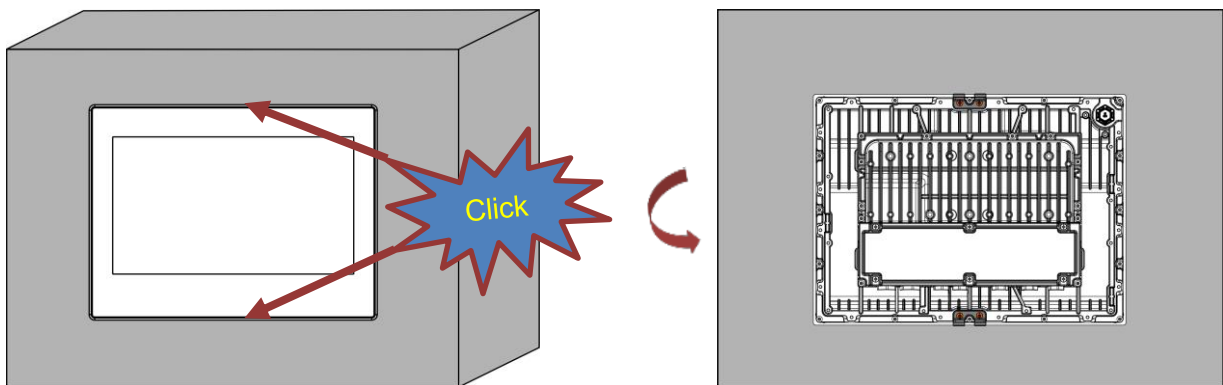

- Assembly of mounting frame
 - consisting of 2 identical L-shaped frame parts
 - all M4 screws (Torx TX20) pre-mounted and secured with captive washers (x2A and x4A frame with 16 screws, x9A frame with 26 screws)

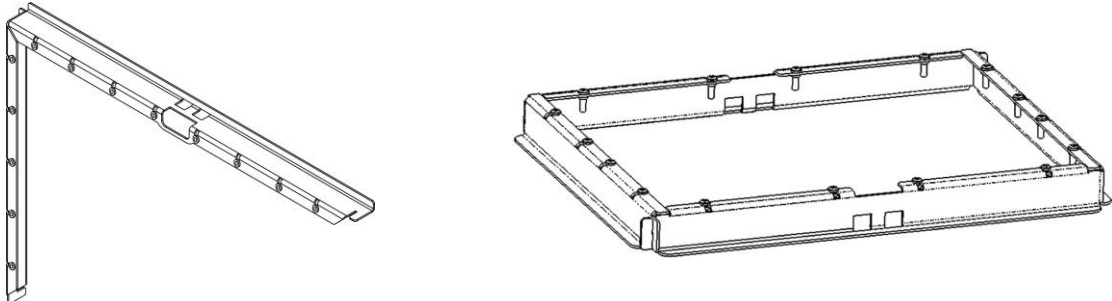

- Slide the fixing frame over the back of the device

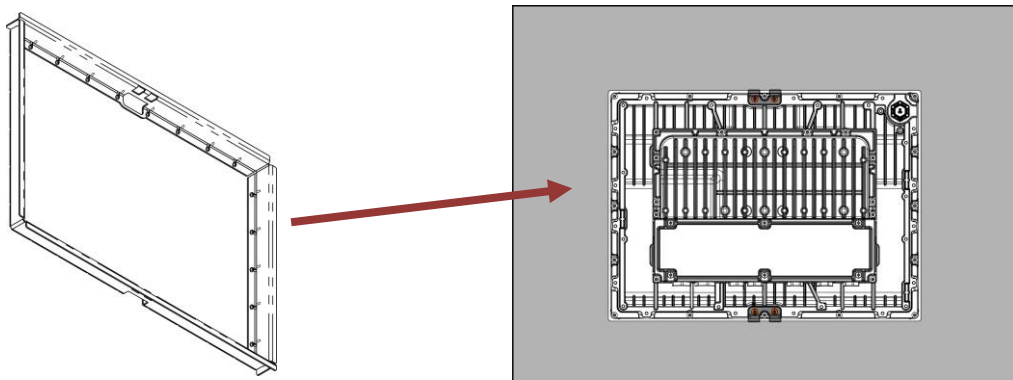

- Tighten all fixing frame screws with 3.5 to 3.7 Nm.
- Observe the order in which screws should be tightened (x4A and x9A frames accordingly)

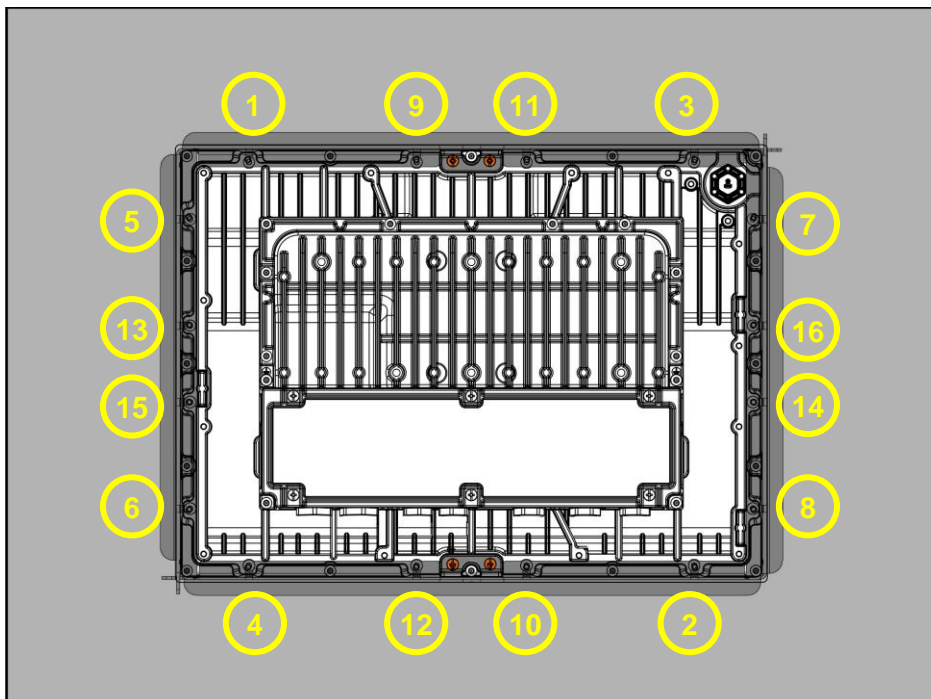

8.5 Installation



Explosion hazard due to improper installation !

Non-compliance may result in fatal or serious injuries.

- Ensure the atmosphere is non-explosive.
- Make sure that the device is not damaged.
- If the device is connected to the mains:
 - Disconnect the device from the power supply.
 - Isolate all circuits and wait 20 minutes before opening the connection box !



Explosion hazard due to electrostatic charge !

Non-compliance may result in fatal or serious injuries.

- Do not apply protective foil to the touch display.



Danger of laser radiation at emitting diode (TD-A, TD-B) or at the end of the fibre optic cable.

Eye injury

The laser diodes in the operating devices, media converters and switches emit invisible laser radiation:

100Base-FX	- 1300 nm
FO-MM / 1000Base-SX	- 770 ... 860 nm
FO-SM / 1000Base-LX	- 1270 ... 1355 nm

According to EN 60825-1, the laser diode is assigned to the laser class 1.

- Do not view the laser radiation directly (within a distance of 100 mm) with optical instruments (e.g. magnifiers, microscopes).

8.5.1 General information on electric connection

- Connect cables carefully.
- Do not screw down on the cable insulation.
- Do not switch cables.
- Observe code of practice when connecting cables.
- Firmly screw down wires.
- Pay attention to the voltage specified on the device:
 - Connect DC devices to 24 VDC only.
 - Connect AC devices to 85 to 250 VAC only.
- Pay attention to specified torques for screws to avoid damage to threads.
- Suitable measures against electrical surge during lightning strike may be necessary.
- Ensure cable shields are firmly secured on all sides. We recommend using suitable cable clips or EMC connections.

8.5.2 Connecting device to power supply

1. Open the cover of the connection box (see chapter [4.4 Connection box](#)).
2. Connect cable to X1 POWER terminal (see chapter [19.1 Connection overview terminal assignment](#)). Ensure correct polarity and power supply (AC or DC).

8.5.3 Grounding the device

- Ground the devices with a core cross section of at least 4 mm² or in line with applicable standards, or connect to the equipotential bonding conductor of the hazardous area.
- Preferably use earth connection at the side closest to the power supply terminals.

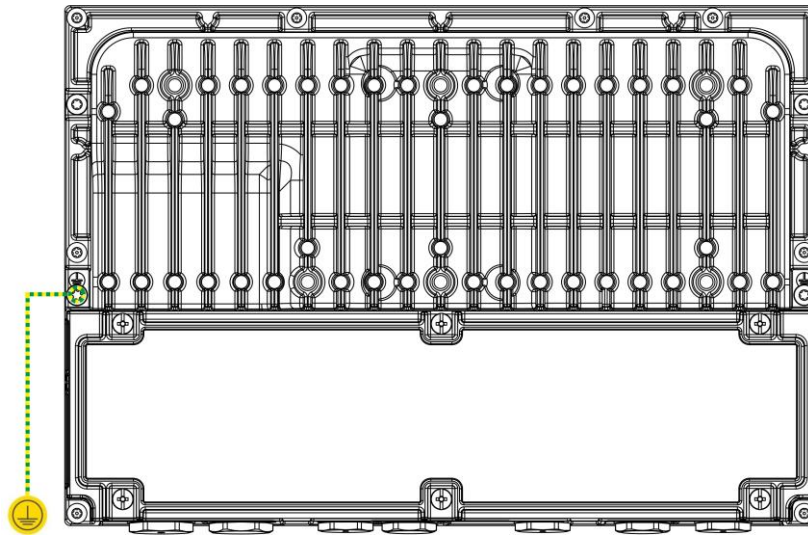

- Tighten earth connection screws with a torque of 3.5 to 3.7 Nm.

Fastening material for the earth connection is located at the device.

8.5.4 Connecting data cable

- Connect the data cables according to the terminal diagram (for copper connections) or connect them to the sockets (for FO connections).

8.5.5 Mounting the cover of the connection box

Tightening torque	
connection box cover screws	3.5 Nm to 3.7 Nm

8.5.6 Connecting associated equipment

The connection box includes mounting options for associated equipment such as cable glands, cable connectors, buttons.

Cable glands or other accessories used in the threads of the connection box must be suitable and certified for the area of installation and might have to be adapted. The applicable Ex requirements and IP65 or above must be met. Potential changes to the ambient parameters such as temperature must be taken into account.

- Observe the specific requirements of the associated equipment used (e.g. permitted cable diameter for cable glands, tightening torques, cable clamps).
- Observe country-specific regulations, in particular any ambient parameters that may be different (e.g. ambient temperature range).
- Attach an easily accessible disconnection mechanism to interrupt the power supply on the outside of the device.
- Close unused openings with a blind plug.
- Cable glands with parallel threads must have the following characteristics:
 - Tolerance class 6H or higher
 - additional seal

8.5.7 Cable glands

In their factory state, the devices are equipped with cable glands or screw plugs. They have been chosen to comply with all relevant certifications of the device. The device's ex-relevant markings also cover the bushings, which are not necessarily separately marked when included in the delivery.

- Seal unused cable glands with certified screw plugs.
- Close any open enclosure holes without cable glands with a certified screw plug. Such certified screw plugs must be approved for the following areas or higher:
 - Certified zone
 - Permitted temperature range
 - Country approval (e.g. ATEX for Europe) of the device
- Alternative, similar and certified cable glands may be used provided they have an equal or higher area of certification (zone) and permitted temperature range, and the same country approval (e.g. ATEX for Europe) as the HMI device.
- Use cable glands with cap nut and without strain relief clamp for permanently installed cables and electrical lines only.
- Install the device in such a way that there is no mechanical impact (tensile force) on the cables. Fix the cable and effectively protect against damage.
- Observe recommended tightening torques. Too low or too high tightening torques might have a negative impact on the type of protection, sealing or strain relief.
- Before commissioning, check any screws that are already mounted and tighten them if necessary.
- Pre-mounted cable glands are designed for non-armoured cables.

- Thread sizes
 E-Box PRO: 1x M25x1.5; 3x M20x1.5; 7x M16x1.5
 E-Box Standard: 2x M20x1.5; 5x M16x1.5
 Optional, pre-mounted cable glands suitable for cable diameters ranging from
 M25 = 14...18 mm, M20 = 6...12 mm, M16 = 4...8 mm.
- Cable glands
 M25 = 14...18mm (Hummel AG part no.: 1.640.2500.50)
 M20 = 6...12 mm (Hummel AG part no.: 1.640.2000.50)
 M16 = 5...10mm (for keyboard KB2) (Hummel AG part no.: 1.640.1611.50)
 M16 = 4...8mm (Hummel AG part no.: 1.610.1600.30)
- Screw plugs:
 M25 (Hummel AG part no.: 1.640.2500.50)
 M20 (Hummel AG part no.: 1.640.2000.50)
 M16 (Hummel AG part no.: 1.640.1611.50)

 The documentation from the manufacturer for the cable glands and screw plugs must be taken into account.

Tightening torque	
Cable glands	Depending on cables used: <ul style="list-style-type: none"> • Individually determine and apply required tightening torques.
Cable glands (installed ex-factory)	In the case of factory-supplied systems, all components are installed correctly and in accordance with applicable standards.

8.5.8 Electric connections of interfaces X1, X2, X3, X4, X5, X6, X7, X9, X10, X11, X12 and X13

Stripping length	9	mm
Mounting torque	0.5 ... 0.6	Nm

Connectable conductor cross section		
• Rigid	0.2 ... 2.5 (24 ... 14)	mm ² (AWG)
• flexible	0.2 ... 2.5 (24 ... 14)	mm ² (AWG)
Multi-conductor connection (flexible with core end sleeve with or without plastic sleeve) (two conductors with the same cross section and conductor type)		
• rigid	0.2 ... 0.75 (24 ... 18)	mm ² (AWG)
• flexible	0.25 ... 1.5 (24 ... 16)	mm ² (AWG)

Notes on screw connectors:

- Ensure that the following maximum rated current values are not exceeded:
 - The maximum rated current value for every contact of the X1 screw connector is 17 A.
- Values that must not be exceeded at the place of installation:
 - Voltage: max. 250 V
 - Short-circuit current: max. 1500 A

- Only use copper wires and cable glands with the following characteristics for connections to the device:
 - For $-20\text{ °C} < T_a \leq +30\text{ °C}$: copper wires / cable glands approved for at least 70 °C
 - For $+30\text{ °C} < T_a \leq +55\text{ °C}$: copper wires / cable glands approved for at least 95 °C

 Observe and apply tightening torques recommended for connection terminals.

8.6 Using USB interfaces

Hardware and connection					
Connection to	intrinsically safe USB devices			non-intrinsically safe equipment	
	safe area	Hazardous areas	Device	safe area	Hazardous areas
X5 (Ex i)	x	x	e.g. KB2-*-HSG-* keyboard cable	–	–
X6 (Ex i)	x	x	e.g. KB2-*-HSG-* pointing device - cable	–	–
X7 / X8 (Ex i)	x	x	e.g. USBi Drive	–	–
X3 (Ex e)	–			any USB device	explosion-protected but non-intrinsically safe devices
at E-Box PRO X11 (Ex e)	-			only for "bus powered / passive devices"	
				any USB device	explosion-protected but non-intrinsically safe devices
at E-Box PRO X12, X13 (Ex e)	-			only if module is equipped only for "bus powered / passive devices"	
				any USB device	explosion-protected but non-intrinsically safe devices

 See also notes on interfaces in chapter [19.1. Connection overview terminal assignment](#).

9 Initial start-up

Conditions:

The device has been installed correctly.

The device has been connected to the equipotential bonding.

1. Since factors such as storage or temperature can have an impact on the cables and cable glands, check the following connections:
 - Connection terminals
 - Existing screw connections
2. Switch on power supply.
 - The device will start up in its standard configuration.
3. Follow the instructions on the screen.



10 (Re-) Commissioning

1. Check the device is correctly installed:
 - Connection terminals
 - Existing screw connections
2. Check the device for visible damage.
 - Only commission the device if there is no visible damage and if it has been correctly installed.
3. Switch on power supply.
 - The device will start up with the configuration saved last.
 - If the connected systems can be reached, communication will be established within the existing parameters.

11 Operation

 DANGER	<p>Explosion hazard due to damaged device ! Non-compliance may result in fatal or serious injuries. In case of damage or changes to the factory state (for example if the device is leaking small glass beads):</p> <ul style="list-style-type: none"> • Decommission device immediately. • Contact manufacturer.
---	--

 DANGER	<p>Explosion hazard due to electrostatic charge ! Non-compliance may result in fatal or serious injuries.</p> <ul style="list-style-type: none"> • Do not apply protective foil to the touch display.
---	--

 WARNING 	<p>Hot surfaces ! Non-compliance may result in minor burns. In ambient temperatures exceeding +45 °C the surface of the device may heat up.</p> <ul style="list-style-type: none"> • Do not touch the device.
---	---

NOTE	<p>Display damage due to permanent display of identical pattern Non-compliance will result in screen burn-in.</p> <ul style="list-style-type: none"> • Use screen savers or regularly move the screen pointer if a specific pattern is displayed permanently.
------	--

11.1 Operating the touch display

NOTE	<p>Touching the touch screen with pointed or sharp items Non-compliance may result in damage to the touch display, shorter life-span or total breakdown !</p> <ul style="list-style-type: none"> • Only operate the touchscreen with your finger or thin / special gloves.
------	---

NOTE	<p>Preventing malfunction and functional impairment Non-compliance will result in malfunction and functional impairment of the touch display !</p> <ul style="list-style-type: none"> • Device must be integrated into the facility's functional earth. • The functional earth is used to suppress electromagnetic disturbance.
------	---

Incorrect operation of the touch display may result in accidental functions and errors. The device will then be unable to execute orders, may execute them incorrectly or in a way not intended.

- Do not realise safety-relevant functions via the touch display.
- Avoid accidental multiple touches.
- Do not touch the touch display across a large section.
- Only use fingers, thin gloves or special gloves for operation.
- Before operating the device, thoroughly acquaint yourself with the multi-touch functions of the operating system and the application.
- Avoid contamination of the touch display with salt water.

11.2 Switching the device on and off

11.2.1 Without optional on/off button

The device is switched on and off via the power supply.

R. STAHL recommend you switch off the ORCA platform devices via the respective Windows / Remote Image function.

11.2.2 With optional on/off button

The device is switched on and off with an optionally available on/off button. The button function is defined via the operating system and functions like power button of a notebook.

R. STAHL recommend you switch off the ORCA platform devices via the respective Windows / Remote Image function.

11.3 Teaming function





Teaming function					
E-Box	Standard	PRO			
		Interface			
Processor	1TX	2TX	1TX + 1FX	1TX + 2SX	1TX + 2LX
ATOM	no	yes	yes	yes	yes
Intel Core i5	-	yes	yes	yes	yes

- Providing redundancy due to automatic switch to a different network adapter.
- Using the Ethernet adapters in the team as standby adapters, realising redundancy, making the system more fail-safe.
- Bundle the speed of the Ethernet adapters in order to increase performance.



For a description of the function and its settings refer to the Remote HMI V6 software manual (industrial-grade Thin Client firmware).

12 Maintenance, overhaul and repair

 DANGER	<p>Explosion hazard due to damaged seal or leaking of filling material ! Non-compliance may result in fatal or serious injuries !</p> <ul style="list-style-type: none"> • In case of damage or changes to the factory state immediately decommission the device. <ul style="list-style-type: none"> ○ If the device leaks filling material (small glass beads) it must be decommissioned immediately. • Contact manufacturer.
 DANGER	<p>Explosion hazard due to incorrect maintenance or repair ! Non-compliance may result in fatal or serious injuries !</p> <ul style="list-style-type: none"> • Ensure the atmosphere is non-explosive. • Make sure that the device is not damaged. • Do not open the enclosure. • If the device is connected to the mains: <ul style="list-style-type: none"> ○ Disconnect the device from the power supply. ○ Isolate supply and all circuits and wait 20 minutes before opening the terminal boxes.
 WARNING 	<p>Hot surfaces ! Non-compliance may result in minor burns ! In ambient temperatures exceeding +45 °C the surface of the device may heat up.</p> <ul style="list-style-type: none"> • Do not touch the device.

Additional for ORCA01M* HMIs:

Do not open, service or repair in an area where an explosive atmosphere may be present.

12.1 Changing the battery

The internal battery may only be replaced by the manufacturer.

12.2 Servicing

The enclosure is sealed and cannot be opened.

When servicing the device, check the following points in addition to those stipulated in the national regulations:

- Damage to seals: cracks or other visible damage to the device enclosure / front glass and / or the protective enclosure.
- All cables and conductors securely connected: cables tightly clamped
- All cables and conductors undamaged
- Compliance with permitted temperature range
- Mounting fits securely, all screws tightened fast
- Ensure the device is used as intended

12.3 Maintenance

The devices are maintenance-free across their entire lifespan.

- Focus on the following during system maintenance:
 - Seal wear, front screen / glass damage
 - screws properly tightened
 - all cables and conductors correctly connected and undamaged

12.4 Repair

The display and E-Box modules cannot be repaired by the customer.

- Any repair on the device is to be performed by R. STAHL only.
- The modules may be sent back separately.
- The modules must be dismantled by qualified staff only (see chapter [3.3 Personnel qualification](#)).

12.4.1 Mounting / dismantling the modules

The ORCA series HMIs consist of a display box module and an E-Box module which are mounted together. These modules can be replaced for repair purposes.

Dismounting modules:

- Disconnect all circuits from the power supply and wait for 20 minutes.
- Remove the connection box cover.
- Disconnect cables and external earthing.
- Unscrew the E-Box screws (see markings).

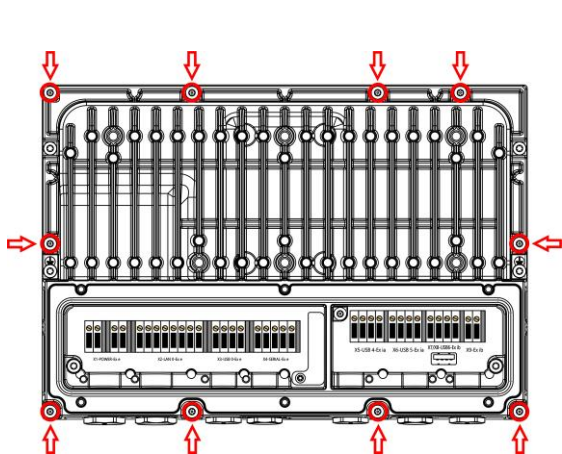

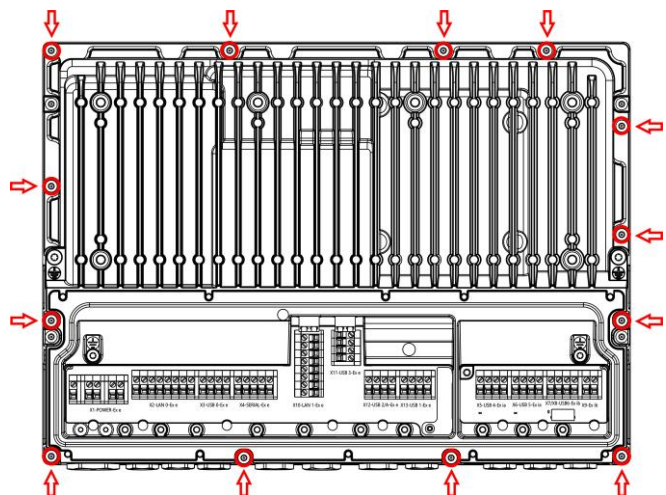

Rear view E-Box Standard



Rear view E-Box PRO

- Lift the E-Box vertically and evenly.
- Do not damage seal.
- Protect plug connector board.

 DANGER	<p>Explosion hazard due to damaged seal ! Non-compliance may result in fatal or serious injuries.</p> <ul style="list-style-type: none"> • Ensure the atmosphere is non-explosive. • Ensure seal is undamaged. • Ensure seal is correctly positioned. • Replace damaged seal immediately.
---	---

<p>NOTE</p> 	<p>Possible mechanical or electric damage to the plug connector board. If the plug connector board is not protected with a cover and suitable ESD measures it may be damaged and the modules' function may be impaired. The plug connector board is a device interface which has been constructed to contain limited ESD protective measures and which can be serviced by trained personnel. To prevent any damage to the components, suitable mechanical and ESD protective measures must be taken.</p> <ul style="list-style-type: none"> • Carry out ESD protective measures before dismounting. • Once dismantled, protect plug connector board.
--	--

Mounting modules:

The steps for mounting the modules are those described in "Dismounting modules" in reverse.

- After removal and installation of the module, the device must correspond to the delivery condition again.
- The chapter on residual risks must be observed. In case of non-observance the explosion protection can be cancelled.
- Where applicable, re-install plug connector board.
- Seal positioned correctly and undamaged.
- Position the E-Box with its 3 lateral fins vertically and in parallel in the corresponding recesses of the D-Box.
- Grease screw connections between E-Box and D-Box.
- Tighten by hand one screw on the right-hand side and one on the left-hand side of the E-Box.
- Insert and tighten all remaining screws crosswise and with the correct torque.

Tightening torque	
Screws connecting the display and the E-Box	3.5 to 3.7 Nm

- Connect cables and external earthing.
- Close connection box cover.
- Operate device.

13 Returning the device

Only return or package the devices after consulting R. STAHL. Contact the responsible representative from R. STAHL. R. STAHL's customer service is available to handle returns if repair or service is required.

Contact customer service via E-mail or telephone:

- E: service.dehm@r-stahl.com
- T: +49 221 76806 3000

Requesting a RMA ticket via our website:

- Go to r-stahl.com.
- Under "Support" > "RMA" > select "RMA-REQUEST".
- Fill out the form and send it in.
- You will automatically receive an E-mail with an RMA ticket.
- Print out the RMA ticket.
- Clearly copy the RMA number onto the outside of the package.
- Send the device with the RMA ticket included in the package to R. STAHL HMI Systems GmbH (see chapter [1.1 Manufacturer](#) for the address).

14 Cleaning

- Check the device for damage before and after cleaning it. Decommission damaged devices immediately.
- Devices located in hazardous areas may only be cleaned with a damp cloth to avoid electrostatic charge.
- When cleaning with a damp cloth, use water or mild, non-abrasive, non-scratching cleaning agents.
- Do not use abrasive cleaning agents or solvents.
- Never clean the device with a strong water jet, such as a pressure washer.

15 Disposal

- Observe national, local and statutory regulations regarding disposal.
- Separate materials for recycling.
- Ensure environmentally friendly disposal of all components according to statutory regulations.

16 Accessories

NOTE	<p>Malfunction or damage to the device due to the use of non-original components.</p> <p>Non-compliance may result in material damage.</p> <ul style="list-style-type: none">• Only use original accessories by the manufacturer.
-------------	--

17 Appendix A

17.1 Technical data E/M5xA

17.1.1 General

Function / Equipment	PM E52A PM M52A	PM E54A PM M54A	PM E59A PM M59A	OS E59A OS M59A
Technology	Panel PCs / Thin Clients			
E-Box	Standard	Standard or PRO		
HMI-type	Panel-mount device			Operator Station
Enclosure type	-			ORCA OS enclosure OFR

17.1.2 Electrical data

Function / Equipment	E52A M52A	E54A M54A	E59A M59A
Power supply	24 VDC	24 VDC or 230 VAC	
AC rated operational voltage	-	230 V	
Voltage range AC	-	100 V - 240 V (+4.1 % / -15 %)	
DC rated operational voltage	24 V	24 V	
Voltage range DC	24 V (+30 % / -20 %)	24 V (+30 % / -20 %)	
Power consumption AC	-	1 A	
Current consumption DC	3 A	3 A	
Frequency range	-	47 – 63 Hz	
Rated operational power	27 – 60 W	27 – 60 W	
internal fuses AC	-	2 A	
internal fuses DC	4 A	6.3 A	
Terminal box	Power supply direct in integrated connection box (separate Ex e and Ex i compartments)		
Connections	via screw terminals, green		
Conductor type	Flexible conductors 0.2 to 2.5 mm ² (AWG24 to AWG12) rigid conductors 0.2 to 2.5 mm ² (AWG24 to AWG12) (details see chapter 8.5.8 Electric connections of interfaces X1, X2, X3, X4, X5, X6, X7, X9, X10, X11, X12 and X13)		
max. operating voltage Um	250 VAC		
Processor type	Intel® ATOM™ E3940	Intel® ATOM™ E3940 Intel® Core i5™ 8365UE	
Processor details	1.6 / 1.8 GHz Quad Core	ATOM: 1.6/ 1.8 GHz, Quad Core i5: 1.6 / 4.1 GHz, Quad Core	
Graphics controller	Intel® HD-Graphics 500	ATOM: Intel® HD-Graphics 500 i5: Intel® UHD-Graphics 620	
Main memory	4 GB / 8 GB	ATOM: 4 GB / 8 GB i5: 16 GB	
Data memory	64 GB - 256 GB		

Operating system	none none / PXE Boot Windows™ 10 2019 LTSC IGEL OS		
Note on operating system	IGEL OS: pre-installed without licence		
Image	Windows™ 10 2019 LTSC 64- bit Windows™ 10 2019 LTSC 64- bit Remote HMI Firmware V6 Windows™ 10 2019 LTSC 64- bit Movicon 11 IGEL OS		
Ethernet note	TX	Optionally:	
		E-Box Standard with 1TX	-
		E-Box PRO with 2TX or 1TX and 1FX or 1TX and 2SX or 1TX and 2LX	
Ethernet / Data	10/100/1000BaseTX	E-Box Standard 10/100/1000BaseTX	-
		E-Box Pro: 2 x 10/100/1000BaseTX, 1x 10/100/1000BaseTX + 1 x 100BaseFX, 1x 10/100/1000BaseTX + 2 x 1000BaseSX, 1x 10/100/1000BaseTX + 2 x 1000BaseLX	
Data cable	CAT5 / 7 AWG23	TX: CAT5 / 7 AWG23 FX / SX: FO cable 50/125 µm or 62.5/125 µm LX: FO cable 9/125 µm	
Length of data cable	100 m	TX: 100 m FX / SX 50 µm: 500 m FX / SX 62.5 µm: 300 m LX: 10 km	
Interface medium	CAT5 / 7 data transmission	TX: CAT5 / 7 data transmission FX / SX: Multi-mode optical cable LX: Single mode optical cable	
Note on data cable	Ex e Screw terminals	TX: Ex e Screw terminals	
Plug version FO	-	LC duplex socket	
USB interface	E-Box Standard: 2x USB Ex ia (for keyboard, pointing device) 1x USB Ex ib (for USBi drive) 1x USB Ex e (LS/FS/HS 500 mA) E-Box PRO: 2x USB Ex ia (for keyboard, pointing device) 1x USB Ex ib (for USBi drive) 1x USB Ex e (LS/FS/HS 500 mA) 1x USB Ex e (LS/FS/HS for bus powered / passive devices only, 500 mA)		
Plug version USB X8	1x USB-A connector		
USB standard	USB 2.0, 480 Mbit/s		
Note on USB interfaces	The USB interfaces are based on the USB 2.0 standard. Ex-protection measures may result in a deviation from the standard (transfer rate or supply current).		
Serial interface	1x RS-232 / RS-422 / RS-485 switchable		
Further connections	Terminals for on/off button		
Status displays	LED's - device is live / power supply OK (orange) - device in operation (white) - access to system disk (white) - Ethernet link established / activity (white)		

Battery	> 5 years	
Capacitor buffer	approx. 4 days	
RFID reader	-	optionally integrated C8
RFID reader chip type	-	NXP CLRC663
RFID operating frequency	-	13.56 MHz (HF)
RFID reading distance	-	<= 50 mm (depending on transponder)
Supported transponder media	Standard	Transponder media
	ISO 14443 A and compatible	MIFARE® Classic Mini / 1K /4K MIFARE Ultralight®, MIFARE Ultralight® C MIFARE® DESFire®EV1, MIFARE® Smart MX MIFARE® Plus S / X MIFARE® Pro X NTAG 21x
	ISO 14443 B and compatible	SRI4K SRIX4K AT88RF020 66CL160S SR176
	ISO 15693 and compatible	EM4135 EM4043 EM4x33 EM4x35 I-Code SLI / SLIX M24LR16/64 TI Tag-it HF-I SRF55Vxx (my-d vicinity)
	ISO 18000-3M3	I-Code ILT-M



Battery

- The self-discharge of the battery at room temperature is very low (<1%) but doubles for each additional 10 °C (25 °C = 1%/a >> 35 °C = 2%/a >> 45 °C = 4%/a ... 65 °C = 16%/a).
- In the case of permanently high temperatures, this self-discharge needs to be taken into account for any life cycle considerations.
- The cumulative time for which a battery is operated at 70 °C across its entire life cycle should not exceed 10 days.

17.1.2.1 Electrical data - device protection



Fuse

- For the external fuse protection of the ORCA device supply, R. STAHL HMI Systems GmbH recommends fuses with the following characteristic values.

Function / Equipment	E-Box Standard	E-Box PRO DC	E-Box PRO AC
Rated Current	2.5 A	4 A	1.25 A
Rated Voltage (minimum)	32 VDC	32 VDC	250 VAC
Breaking capacity	1500 A		
Melting integral (I²t)	≥ 2 A²s	≥ 10 A²s	≥ 0.8 A²s

17.1.3 Display

Function / Equipment	E52A M52A	E54A M54A	E59A M59A
Display-Version	TFT colour display		
Display version 2	16.7 million colours	16.2 million colours	16.7 million colours
Display size inch	12.1	15.6	21.5
Display size cm	30.7	39.6	54.6
Display resolution (supported)	1280 x 800 (native) 800 x 600 800 x 480 640 x 480	1920 x 1080 (native) 1680 x 1080 1280 x 1024 1024 x 768	
Display dimensions	16:10	16:9	
Display brightness	400 cd/m ²	450 cd/m ²	350 cd/m ²
Display contrast	1:800	1:1000	
Backlight	LED technology		
Life expectancy backlight	50,000 h at +25 °C		
Sensors	-		4
Touchscreen	yes		
Touch screen technology	projected, capacitive (PCAP), multi-touch		
Touchscreen activation	Touch, no activation pressure required		
Touchscreen input method	Fingers, thin glove or special glove		
Touch screen durability	very good		
Touchscreen resistance to scratching MoHS scale	>5		
Touchscreen resistance to scratching pencil hardness test ISO 15184	9H		
Touchscreen transmissivity / optics	very good		
Touchscreen surface contaminants	unaffected (however, can be affected by conductive fluids such as saltwater)		
Touchscreen abrasion resistance	no abrasion by finger or rubber		
Front plate	Glas, polyester on powder-coated aluminium		
Glass pane	hardened, impact-resistant		
Glass pane impact energy	4 J from a height of 40 cm		

17.1.4 Ambient conditions

Function / Equipment	PM E52A PM M52A	PM E54A PM M54A	PM E59A PM M59A	OS E59A OS M59A
Operating temperature range	-20 °C ... +55 °C			-20 °C ... +50 °C
Storage temperature	-40 °C ... +60 °C			
Relative humidity	10 to 90% at +40°C [+104 °F], non-condensing			
Vibration (sinusoidal)	5 to 13.2 Hz: ±1 mm 13.2 to 100 Hz: ±0.7 g X, Y, Z axes			
Shock	15 g / 11 ms			
Pressurised operation	< = 20 mbar			

17.1.5 Mechanical data

Function / Equipment	PM E52A PM M52A	PM E54A PM M54A	PM E59A PM M59A	OS E59A OS M59A
Dimensions (W x H)	330 mm x 241 mm	415 mm x 310 mm	565 mm x 400 mm	708 mm x 524 mm
Total depth (D)	101 mm	with E-Box Standard: 108 mm		176 mm
		with E-Box PRO: 117 mm		
Wall cut-out (W x H)	310 mm x 221 mm	396 mm x 291 mm	547 mm x 382 mm	-
Cut-out tolerances	+1.0 mm / -0.5 mm		+/-0.5 mm	
Depth of cut-out (D)	92 mm	with E-Box Standard:		-
		98 mm	99 mm	-
		with E-Box PRO: 108 mm		-
Dimensions with keyboard (W x H x D)	-			708 mm x 794 mm x 404 mm
Enclosure design	-			Cleanroom suitability
Weight				
with E-Box Standard	ET = 10 kg	ET = 15 kg	ET = 21 kg	ET = 41.5 kg
	MT = 7 kg	MT = 9 kg	MT = 15 kg	MT = 35.5 kg
with E-Box PRO	-	ET = 19 kg	ET = 25 kg	ET = 45.5 kg
	-	MT = 11 kg	MT = 17 kg	MT = 37.5 kg
Material (front)	Glas, polyester on powder-coated aluminium			Stainless steel, glass and polyester on powder-coated aluminium
Material (back)	Aluminium			Stainless steel
Degree of protection (IP)	IP66, Ex-enclosure protection type IP65			
Front enclosure protection type (IP)	IP66, Ex-enclosure protection type IP65			
Enclosure back protection type (IP)	IP66, Ex-enclosure protection type IP65			
Mounting option	Panel mount			Wall-mounting or mounted on stand / elbow
Mounting orientation	any			-
Wall thickness of installation wall	1.5 – 12 mm			-

17.2 Technical data E/M79A

17.2.1 General

Function / Equipment	PM E79A PM M79A	OS E79A OS M79A
Technology	Direct Monitor	
E-Box	PRO	
HMI-type	Panel-mount device	Operator Station
Enclosure type	-	ORCA OS enclosure OFR

17.2.2 Electrical data

Function / Equipment	E79A M79A
Power supply	24 VDC or 230 VAC
AC rated operational voltage	230 V
Voltage range AC	100 V - 240 V (+4.1 % / -15 %)
DC rated operational voltage	24 V
Voltage range DC	24 V (+30 % / -20 %)
Power consumption AC	1 A
Current consumption DC	3 A
Frequency range	47 – 63 Hz
Rated operational power	27 – 60 W
internal fuses AC	2 A
internal fuses DC	6.3 A
Terminal box	Power supply direct in integrated connection box (separate Ex e and Ex i compartments)
Connections	via screw terminals, green
Conductor type	Flexible conductors 0.2 to 2.5 mm ² (AWG24 to AWG12) rigid conductors 0.2 to 2.5 mm ² (AWG24 to AWG12) (details see chapter 8.5.8 Electric connections of interfaces X1, X2, X3, X4, X5, X6, X7, X9, X10, X11, X12 and X13)
max. operating voltage Um	250 V AC
Status displays	LED's - device is live / power supply OK (orange) - device in operation (white)

17.2.2.1 Electrical data - device protection

	<p>Fuse</p> <ul style="list-style-type: none"> For the external fuse protection of the ORCA device supply, R. STAHL HMI Systems GmbH recommends fuses with the following characteristic values.
---	---

Function / Equipment	E-Box PRO DC	E-Box PRO AC
Rated Current	4 A	1.25 A
Rated Voltage (minimum)	32 VDC	250 VAC
Breaking capacity	1500 A	
Melting integral (I ^{2t})	≥ 10 A ² s	≥ 0.8 A ² s

17.2.3 Display

Function / Equipment	E79A M79A
Display-Version	TFT colour display
Display version 2	16.7 million colours
Display size inch	21.5
Display size cm	54.6
Display resolution	1920 x 1080 (native)
Display dimensions	16:9
Display brightness	350 cd/m ²
Display contrast	1:1000
Backlight	LED technology
Life expectancy backlight	50,000 h at +25 °C
Sensors	4
Touchscreen	yes
Touch screen technology	projected, capacitive (PCAP), multi-touch
Touchscreen activation	Touch, no activation pressure required
Touchscreen input method	Fingers, thin glove or special glove
Touch screen durability	very good
Touchscreen resistance to scratching MoHS scale	>5
Touchscreen resistance to scratching pencil hardness test ISO 15184	9H
Touchscreen transmissivity / optics	very good
Touchscreen surface contaminants	unaffected (however, can be affected by conductive fluids such as saltwater)
Touchscreen abrasion resistance	no abrasion by finger or rubber
Front plate	Glas, polyester on powder-coated aluminium
Glass pane	hardened, impact-resistant
Glass pane impact energy	4 J from a height of 40 cm

17.2.4 Ambient conditions

Function / Equipment	PM E79A PM M79A	OS E79A OS M79A
Operating temperature range	-20 °C ... +55 °C	-20 °C ... +50 °C
Storage temperature	-40 °C ... +60 °C	
Relative humidity	10 to 90% at +40°C [+104 °F], non-condensing	
Vibration (sinusoidal)	5 to 13.2 Hz: ±1 mm 13.2 to 100 Hz: ±0.7 g X, Y, Z axes	
Shock	15 g / 11 ms	
Pressurised operation	< = 20 mbar	

17.2.5 Mechanical data

Function / Equipment	PM E79A PM M79A	OS E79A OS M79A
Dimensions (W x H)	565 mm x 400 mm	565 mm x 400 mm
Total depth (D)	117 mm	176 mm
Wall cut-out (W x H)	547 mm x 382 mm	-
Cut-out tolerances	+/-0.5 mm	
Depth of cut-out (D)	108 mm	-
Dimensions with keyboard (W x H x D)	-	708 mm x 794 mm x 404 mm
Enclosure design	-	Cleanroom suitability
Weight [kg]	ET = 25 kg MT = 17 kg	ET = 45.5 kg MT = 37.5 kg
Material (front)	Glas, polyester on powder-coated aluminium	Stainless steel, glass and polyester on powder-coated aluminium
Material (back)	Aluminium	Stainless steel
Degree of protection (IP)	IP66, Ex-enclosure protection type IP65	
Front enclosure protection type (IP)	IP66, Ex-enclosure protection type IP65	
Enclosure back protection type (IP)	IP66, Ex-enclosure protection type IP65	
Mounting option	Panel mount	Wall-mounting or mounted on stand / elbow
Mounting orientation	any	-
Wall thickness of installation wall	1.5 – 12 mm	-

17.3 Cable glands

17.3.1 E-Box Standard

Cable gland	Type	HSK-M-Ex
	Manufacturer	Hummel AG
	Number	2x M16 / 1x M20
	Thread size	M16 x 1.5 / M20 x 1.5
	Clamping range	1x M16 = 4 ... 8 mm / 1x M16 = 5 ... 10 mm / M20 = 6 ... 12 mm
	Width across flats	M16 = SW 17 or SW 19 / M20 = SW 22
	Tightening torque	6 Nm / 5 Nm / 8 Nm
Screw plug	Type	V-Ms-VMQ-Ex
	Manufacturer	Hummel AG
	Number	5x M16 / 2x M20
	Width across flats	M16 = SW 19 / M20 = SW 22
	Tightening torque	6 Nm / 8 Nm

! The documentation from the manufacturer for the cable glands and screw plugs must be taken into account.

The E-Box is fully equipped with screw plugs.
There are 2x M16 / 1x M20 cable glands included as a set.

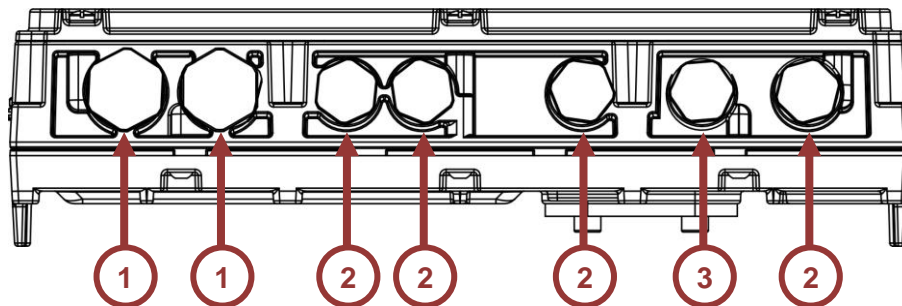

Item	Designation
1	Screw plug M20
2	Screw plug M16
3	Screw plug M16, space for cable gland 5 ... 10 mm for KB2 keyboard

! Additional cable glands can be ordered as a set (SAP 310903 - Supplemental cable glands kit E-Box STD)

17.3.2 E-Box PRO

Cable gland	Type	HSK-M-Ex
	Manufacturer	Hummel AG
	Number	6x M16 / 1x M20 / 1x M25
	Thread size	M16 x 1.5 / M20 x 1.5 / M25 x 1.5
	Clamping range	5x M16 = 4 ... 8 mm / 1x M16 = 5 ... 10 mm / M20 = 6 ... 12 mm / M25 = 14 ... 18 mm
	Width across flats	5x M16 = SW 17 or SW 19 / M20 = SW 22 / M25 = SW 30
	Tightening torque	6 Nm / 5 Nm / 8 Nm / 12 Nm
Screw plug	Type	V-Ms-VMQ-Ex
	Manufacturer	Hummel AG
	Number	7x M16 / 3x M20 / 1x M25
	Width across flats	M16 = SW 19 / M20 = SW 22 / M25 = SW 30
	Tightening torque	6 Nm / 8 Nm / 12 Nm



The documentation from the manufacturer for the cable glands and screw plugs must be taken into account.

The E-Box is fully equipped with screw plugs.
There are 6x M16 / 1x M20 / 1x M25 cable glands included as a set.

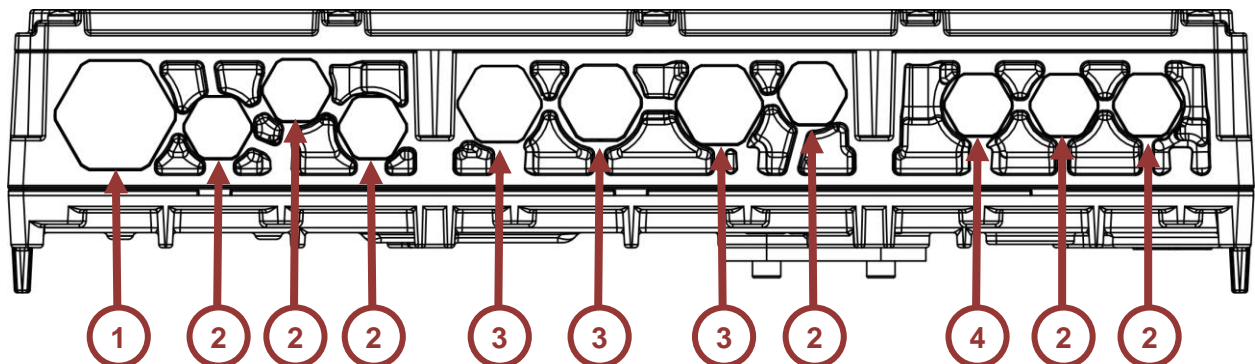

Item	Designation
1	Screw plug M25
2	Screw plug M16
3	Screw plug M20
4	Screw plug M16, space for cable gland 5 ... 10 mm for KB2 keyboard



Additional cable glands can be ordered as a set (SAP 310902 - Supplemental cable glands kit E-Box PRO)

17.4 Overview Hardware Revision ORCA01

HW-Rev.	Device type	Technical modifications	Modification date Hardware	BA version	BA date
01.01.01	ORCA01E* ORCA01M*	Initial	-	01.00.04	17.05.2023

18 Appendix B

18.1 Connection values

Nominal voltage	Input voltage range	Rated frequency	max. power consumption
230 VAC	85 – 250 VAC	47 – 63 Hz	1 A
24 VDC	19.2 – 31.2 VDC	–	3 A

18.2 Intrinsically safe interfaces

18.2.1 X9 PB – on/off button (Ex ia)

X9: PB, on/off button (X9-1), GND (X9-2):

Max. output voltage	U_o	=	5.36	VDC				
Max. output current	I_o	=	45	mA				
Max. output power	P_o	=	0.061	W				
Trapezoidal output characteristics								
Max. external capacitance	C_o	=	64	20				μF
Max. external inductance	L_o	=	0.89	3.89				μH

C_o and L_o pairs directly above / underneath each other may be used.
For the connection of passive devices only.

18.2.2 X5 / X6 – USB 4/5 (Ex ia)

X5 / X6 – USB 4/5 terminals VBUS (X5/6-1), D- (X5/6-2), D+ (X5/6-3), GND (X5/6-4):

Max. output voltage	U_o	=	5.36	VDC				
Max. output current	I_o	=	249	mA				
Max. output power	P_o	=	0.55	W				
Trapezoidal output characteristics								
Max. external capacitance	C_o	=	65	46	32	25	21	μF
Max. external inductance	L_o	=	1	2	3	4	5	μH

C_o and L_o pairs directly above / underneath each other may be used.
For the connection of intrinsically safe passive devices only.

18.2.3 X7 / X8 – USB 6 (Ex ib)

X7 – USB terminals VBUS (X7-1), D- (X7-2), D+ (X7-3), GND (X7-4):

Max. output voltage	U_o	=	5.54	VDC				
Max. output current	I_o	=	0.757	A				
Max. output power	P_o	=	3.9	W				
Trapezoidal output characteristics								
Max. external capacitance	C_o	=	48.6	33.6	21.6	15.6	11.6	μF
Max. external inductance	L_o	=	1	2	3	4	5	μH

C_o and L_o pairs directly above / underneath each other may be used.
For the connection of intrinsically safe passive devices only.

X8 – USB A fixed socket

18.3 Optical interfaces

18.3.1 X15 / X16 – FO 1 / FO 2 type FX

Wavelength	=	1310	nm
------------	---	------	----

Optical radiation sources are used in EPL Gb or Gc and Db or Dc, which comply with the Class 1 limiting values according to IEC 60825-1.

18.3.2 X15 / X16 – FO 1 / FO 2 type SX

Wavelength	=	850	nm
------------	---	-----	----

Optical radiation sources are used in EPL Gb or Gc and Db or Dc, which comply with the Class 1 limiting values according to IEC 60825-1.

18.3.3 X15 / X16 – FO 1 / FO 2 type LX

Wavelength	=	1310	nm
------------	---	------	----

Optical radiation sources are used in EPL Gb or Gc and Db or Dc, which comply with the Class 1 limiting values according to IEC 60825-1.

18.4 Non intrinsically safe interfaces (Ex e)

18.4.1 X1 – Power supply

Nominal voltage			
• Device version AC	=	85 ... 250	VAC
• Device version DC	=	19.2 ... 31.2	VDC
Nominal current			
• Device version AC	=	max. 2	A
• Device version DC	=	max. 6.3	A
Nominal power	=	16 - 60	W
Max. input voltage	U_m	=	250 VAC
Frequency for AC	=	47 – 63	Hz

18.4.2 X2 / X10 – copper1 / copper2

Nominal voltage	=	5	VAC / VDC
Max. input voltage	U_m	=	250 VAC 30 VDC

18.4.3 X3 / X11 / X12 / X13 – USB

Nominal voltage	=	5	VAC / VDC
Max. input voltage	U_m	=	30 VAC

X11 / X12 / X13: for the connection of passive devices only

18.4.4 X4 – RSxxx

Nominal voltage	=	±12	VAC / VDC
Max. input voltage	U_m	=	30 VAC

19 Appendix C

19.1 Connection overview terminal assignment

19.1.1 E-Box Standard

19.1.1.1 Ex e terminals

Terminal	Pin	Designation (PCB) / view			Typical colour coding / plug type	Connection / function
X1 POWER	1	+24 V			Red	Power supply of the HMI device DC
	2	+24 V			Red	
	3	0 V			Black	
	4	0 V			Black	
X2 LAN 0		1000Base-TX	100Base-TX			Data cable Copper connection 1
	1	MDI0+	TX+		Orange / White	
	2	MDI0-	TX-		Orange	
	3	MDI1+	RX+		Green / White	
	4	MDI1-	RX-		Green	
	5	MDI2+			White / Blue	
	6	MDI2-			Blue	
	7	MDI3+			White / Brown	
X3 USB 0	1	VBUS			Red	USB connection
	2	D -			White	
	3	D +			Green	
	4	GND			Black	
X4 SERIAL		RS-232	RS-422	RS-485		Serial interface (COM) RS-232 / RS-422 / RS-485
	1	RTS	TxD-B	B		
	2	TxD	TxD-A	A		
	3	RxD	RxD-B			
	4	CTS	RxD-A			
	5	GND				

NOTE

Connection of components with excessive voltages to X3 USB 0

Non-compliance will trigger internal fuses and lead to failure of the USB interface !

- A self-powered or bus-powered / passive device may be connected.

The voltage at this interface must not exceed the value specified according to USB 2.0. Higher voltage will trigger the fuses !

NOTE	<p>Connection of components with excessive voltage to X4 SERIAL</p> <p>Non-compliance will trigger internal fuses and lead to failure of the serial interface !</p> <ul style="list-style-type: none"> The voltage at this interface must not go outside the range of -12 V ... +12 V. Higher or lower voltages will trigger the fuses !
-------------	--

19.1.1.2 Ex i terminals

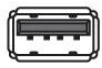
Terminal	Pin	Designation (PCB) / view	Typical colour coding / plug type		Connection / function
			General	Cable from KB2	
X5 USB 4	1	VBUS	Red	White	USB connection for KB2 max. 50 mA
	2	D -	White	Green	
	3	D +	Green	Yellow	
	4	GND	Black	Brown	
X6 USB 5	1	VBUS	Red	Red	USB connection for KB2 max. 50 mA
	2	D -	White	Grey	
	3	D +	Green	Pink	
	4	GND	Black	Blue	
X7 / X8 USB 6	1	VBUS	Red		USB connection (Terminals or sockets)
	2	D -	White		
	3	D +	Green		
	4	GND	Black		
			USB socket Type A		
X9 PB	1	PWRBTN			On / off button connection
	2	PWRBTN RETURN			

NOTE	<p>Short circuit of the terminal connection at X7 / X8 USB 6</p> <p>Non-compliance will trigger internal fuses and lead to failure of the USB interface !</p> <ul style="list-style-type: none"> You may only connect a bus-powered / passive device that is supplied by the ORCA device via the bus. Connect such a device via terminal X7 or the X8 USB terminal. Prevent short circuiting of the VBUS and D+ as well as the VBUS and D- terminals. Short-circuiting will trigger the fuses !
-------------	---

	<p>X9 PB terminals</p> <ul style="list-style-type: none"> Only connect a passive button.
---	---

19.1.2 E-Box PRO

19.1.2.1 Ex e terminals

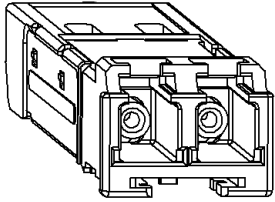
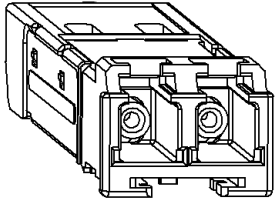
Terminal	Pin	Designation (PCB) / view		Typical colour coding / plug type	Connection / function
X1 POWER	0	Earth		Green-Yellow	Power supply of the HMI device (either AC or DC)
	1	+24 V / L		Red / Black	
	2	+24 V / L		Red / Black	
	3	0V / N		Black / Blue	
	4	0V / N		Black / Blue	
X2 * LAN 0		1000Base-TX	100Base-TX		Data cable
	1	MDI0+	TX+	Orange / White	Copper connection 1
	2	MDI0-	TX-	Orange	
	3	MDI1+	RX+	Green / White	
	4	MDI1-	RX-	Green	
	5	MDI2+		White / Blue	
	6	MDI2-		Blue	
	7	MDI3+		White / Brown	
	8	MDI3-		Brown	
X10 * LAN 1		1000Base-TX	100Base-TX		
	1	MDI0+	TX+	Orange / White	Copper connection 2
	2	MDI0-	TX-	Orange	
	3	MDI1+	RX+	Green / White	
	4	MDI1-	RX-	Green	
	5	MDI2+		White / Blue	
	6	MDI2-		Blue	
	7	MDI3+		White / Brown	
	8	MDI3-		Brown	
X15 * FO 1				LC duplex connector	
X16 * FO 2				LC duplex connector	Data cable FO connection 2 Type FX (100Base-FX) Type SX (1000Base-SX) Type LX (1000Base-LX)

X3 USB 0	1	VBUS			Red	USB connection
	2	D -			White	
	3	D +			Green	
	4	GND			Black	
X11 USB 3	1	VBUS			Red	USB connection (optional - assembly version)
	2	D -			White	
	3	D +			Green	
	4	GND			Black	
X13 USB 1	1	VBUS			Red	USB connection
	2	D -			White	
	3	D +			Green	
	4	GND			Black	
X4 SERIAL		RS-232	RS-422	RS-485		Serial interface (COM) RS-232 / RS-422 / RS-485
	1	RTS	TxD-B	B		
	2	TxD	TxD-A	A		
	3	RxD	RxD-B			
	4	CTS	RxD-A			
	5	GND				
X12 USB 2/A	1	VBUS			Red	USB connection (optional - assembly version)
	2	D -			White	
	3	D +			Green	
	4	GND			Black	
X12 USB 2/A	1	SPK+				Audio connection (optional - assembly version) (for ATOM processor only)
	2	-				
	3	-				
	4	SPK-				

 * The Ethernet connection depends on the version ordered.
The LC duplex slots are only available in the FO version.
The board is always fitted with all terminals, but they only have a function if required by the assembly version.
The X12 terminal is always optional and either a USB or an audio connection.

 Terminals X13 USB 1 and X11 USB 3

- You may only connect a bus-powered / passive device that is supplied by the ORCA device via the bus.

Terminals X12 USB 2/A

- If fitted with USB module: you may only connect a bus-powered / passive device that is supplied by the ORCA device via the bus.
- If fitted with audio module: you may only connect a passive speaker.

NOTE	Connection of components with excessive voltages to X3 USB 0 Non-compliance will trigger internal fuses and lead to failure of the USB interface ! <ul style="list-style-type: none">• A self-powered or bus-powered / passive device may be connected. The voltage at this interface must not exceed the value specified according to USB 2.0. Higher voltage will trigger the fuses.
NOTE	Connection of components with excessive voltage to X4 SERIAL Non-compliance will trigger internal fuses and lead to failure of the serial interface ! <ul style="list-style-type: none">• The voltage at this interface must not go outside the range of -12 V ... +12 V. Higher or lower voltages will trigger the fuses.

19.1.2.2 Ex i terminals

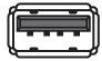
Terminal	Pin	Designation (PCB) / view	Typical colour coding / plug type		Connection / function
			General	Cable from KB2	
X5 USB 4	1	VBUS	Red	White	USB connection for KB2 max. 50 mA
	2	D -	White	Green	
	3	D +	Green	Yellow	
	4	GND	Black	Brown	
X6 USB 5	1	VBUS	Red	Red	USB connection for KB2 max. 50 mA
	2	D -	White	Grey	
	3	D +	Green	Pink	
	4	GND	Black	Blue	
X7 / X8 USB 6	1	VBUS	Red		USB connection (Terminals or sockets)
	2	D -	White		
	3	D +	Green		
	4	GND	Black		
			USB socket Type A		
X9 PB	1	PWRBTN			On / off button connection
	2	PWRBTN RETURN			

NOTE	<p>Short circuit of the terminal connection at X7 / X8 USB 6 Non-compliance will trigger internal fuses and lead to failure of the USB interface !</p> <ul style="list-style-type: none"> • You may only connect a bus-powered / passive device that is supplied by the ORCA device via the bus. • Connect such a device via terminal X7 or the X8 USB terminal. • Prevent short circuiting of the VBUS and D+ as well as the VBUS and D- terminals. Short-circuiting will trigger the fuses !
-------------	--

	<p>X9 PB terminals</p> <ul style="list-style-type: none"> • Only connect a passive button.
---	---

19.1.3 Direct Monitor

19.1.3.1 Ex e terminals

Terminal	Pin	Designation (PCB) / view	Typical colour coding / plug type	Connection / function
X1 POWER	0	Earth	Green-Yellow	Power supply of the HMI device (either AC or DC)
	1	+24 V / L	Red / Black	
	2	+24 V / L	Red / Black	
	3	0V / N	Black / Blue	
	4	0V / N	Black / Blue	
X3 USB 0	1	N.C.	Red	USB monitor connection
	2	D -	White	
	3	D +	Green	
	4	GND	Black	
X2		LAN 0		no function
X4		SERIAL		no function
X10		LAN 1		no function
X11		USB 3		no function
X12		USB 2/A		no function
X13		USB 1		no function



All terminals are located on the board but only terminal X3 is functionally present for the connection of the monitor.

19.1.3.2 Ex i terminals

Terminal	Pin	Designation (PCB) / view	Typical colour coding / plug type	Connection / function
X5		USB 4		no function
X6		USB 5		no function
X7 / X8		USB 6		no function
X9		PB		no function



All terminals are located on the board but have no function.

20 Appendix D

20.1 Variation of operating temperature range

The devices' operating temperature range is impacted by how they are mounted. The minimum and maximum permitted operating temperature may vary depending on their mounting type.







These values are listed in the table below.



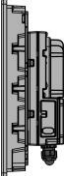

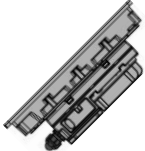
NOTE	<p>Exposure to direct sunlight might contribute to further heating up the device and may result in a further reduction of the maximum permitted operating temperature. We recommend you protect the device from direct sunlight.</p> <p>Wind may cool down the device and thus have an impact on the minimum operating temperature.</p>
-------------	---

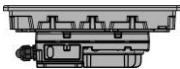
	The storage temperature is not impacted by the type of installation.
---	--

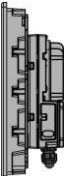
The following values apply:

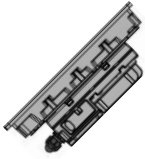
- LTC = lower ambient temperature in °C
-20 °C
- LTF = lower ambient temperature in °F
+14 °F
- HTC = highest permissible ambient temperature in °C
- HTF = highest permissible ambient temperature in °F

Screen position	Inclination	Description	Highest permissible ambient temperature
		Landscape, horizontal 90° free standing	HTC = +55 °C HTF = +131 °F
		Landscape, horizontal 45° free standing	HTC = +55 °C HTF = +131 °F
		Landscape, horizontal 0° free standing Minimum distance 10 cm below device	HTC = 55 °C HTF = +131 °F
		Portrait vertical 90°, free standing	HTC = +55 °C HTF = +131 °F

Screen position	Inclination	Description	Highest permissible ambient temperature
		Portrait vertical 45°, free standing	HTC = +55 °C HTF = +131 °F
		Landscape, horizontal Mounted in enclosure any degree of inclination	HTC = +50 °C HTF = +122 °F
		Portrait, horizontal Mounted in enclosure any degree of inclination	HTC = +50 °C HTF = +122 °F

21 Appendix E

21.1 Disposal / restricted substances

Disposal of old electric and electronic devices, packaging and used parts is subject to regulations valid in whichever country the device has been installed.

For countries under the jurisdiction of the EU the corresponding WEEE directive applies.

The devices are classified according to the table below:

Directive	WEEE II Directive 2012/19/EU
Valid	from 15.08.2018
Category	SG2 screens, monitors, devices with monitors >100 cm ²

R. STAHL HMI Systems GmbH meets the requirements of directive 2012/19/EU (WEEE) and is registered under the number DE 15180083.

We shall take back our devices according to our General Terms and Conditions.

21.1.1 Declaration of substances and restricted substances

This declaration is based on the procedure described in the international standard and directives as listed in the table below:

- IEC 62474 : 2018 (DIN EN IEC 62474 : 2019-09)
- (EG) Nr. 1907/2006 (REACH)
- Directive 2011/65/EU (RoHS)
- Resolution MEPC.269(68) "International Maritime Organization" (IMO); particularly "2015 Guidelines for the Development of the Inventory of the Hazardous Materials" (IHM)

21.1.1.1 Declarable substance groups

ECHA Legal Entity UUID of the R. STAHL HMI Systems GmbH:
ECHA-a4dd94d5-bcd2-405d-8fdd-010a535d7e87

SCIP number:

Component	Designation	Mass (g)	Declarable Substance Groups and Substances (IEC 62474 database)	CAS No.	Mass %	Exemption (acc. to directive)
CR2032 MFR	Lithium button cell battery	2.8	1,2 Dimethoxyethane (DME) EINECS 203-794-9	110-71-4	over 0.1 by weight	-

21.1.1.2 RoHS directive 2011/65/EC

The devices meet the requirements of RoHS Directive 2011/65/EU.

21.1.1.3 IMO Resolution MEPC.269(68)

The devices meet the requirements of the MEPC.269(68) Resolution of the "International Maritime Organization" (IMO), in particular the "2015 Guidelines for the Development of the Inventory of the Hazardous Materials" (IHM).

22 Appendix F

22.1 Material resistance

This section lists the material resistance to chemicals of ORCA components that may come into contact with the external environment.

The selection of the individual chemicals listed does not claim to be complete.

22.1.1 Material

Item	Designation	Material
1	Front plate	Aluminium
2	Powder coating	Tiger Drylac Series 29
3	Enclosure	Aluminium
4	Front plate seal	Silicone VMQ
5	Front plate foil	MacDermid Autotex XE Polyester
6	Front glass	Glass, thermally toughened

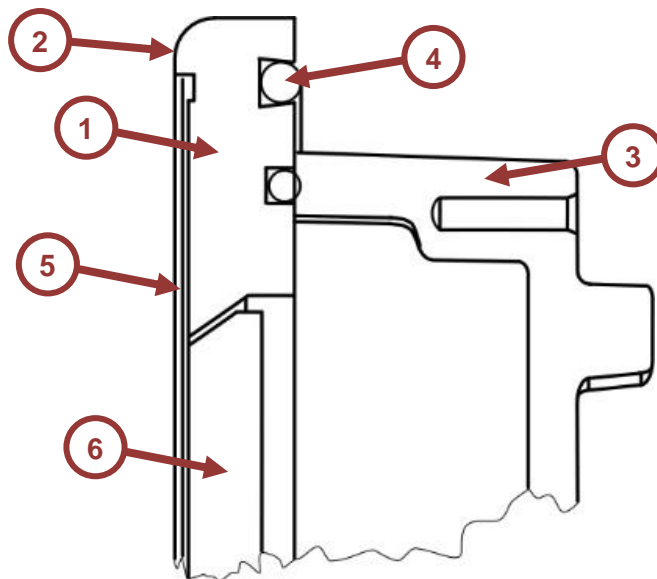

22.1.1.1 Aluminium

Aluminium is relatively corrosion-resistant and very durable in air and water. In air, aluminium forms an oxide layer that protects against corrosion.

There are various lists on the Internet for resistance to chemicals, so that a list can be dispensed with at this point.

22.1.1.2 Powder coating

Chemicals	Resistance					
	7 days	1 month	3 months	6 months	9 months	12 months
Ammonia 10 %	moderate	moderate	-	-	-	-
Sodium hydroxide solution 10 %	yes	yes	moderate	-	-	-
Soda 10 %	yes	yes	yes	yes	yes	yes
Acetic acid 10 %	yes	yes	moderate	-	-	-
Lactic acid 10 %	yes	yes	yes	yes	yes	yes
Phosphoric acid 10 %	yes	yes	yes	yes	yes	yes
Nitric acid 10 %	yes	yes	moderate	moderate	-	-
Hydrochloric acid 10 %	yes	yes	yes	moderate	moderate	moderate
Sulfuric acid 32 %	yes	yes	moderate	moderate	moderate	-
Ethanol 96 %	yes	yes	yes	yes	yes	yes
Isopropyl alcohol	yes	yes	yes	yes	yes	yes
Ethyl acetate	no	-	-	-	-	-
Toluene	no	-	-	-	-	-
Xylene	no	-	-	-	-	-
Diesel	yes	yes	yes	yes	yes	yes
FAM-Testing fuel	moderate	moderate	moderate	no	no	no
Petrol	yes	yes	yes	yes	yes	yes
Seewater	yes	yes	yes	yes	yes	yes

22.1.1.3 Front plate seal

The VMQ material has very good weathering and ageing resistance, excellent rubber elastic properties and outstanding temperature resistance.

The tables contain an evaluation of the chemical resistance of VMQ to the respective chemical. Unless otherwise stated, the data refer to room temperature.

No to little change in properties		
Aluminium phosphate (aqueous solution)	Aluminium sulphate (aqueous solution)	Ammonia (gaseous, hot)
Ammonia (gaseous, cold)	Ammonium hydroxide (concentrated)	Ammonium phosphate (aqueous solution)
Arsenic acid	Barium chloride (aqueous solution)	Barium hydroxide (aqueous solution)
Barium sulphate (aqueous solution)	Barium sulphide (aqueous solution)	Cottonseed oil
Beer	Boric acid	Calcium chloride (aqueous solution)
Calcium hydrogen sulphite (aqueous solution)	Calcium hydroxide (aqueous solution)	Dimethyl ether (methyl ether)
Developing fluid (photography)	Natural gas	Peanut oil
Vinegar	Acetic acid, 30%	Ethyl alcohol (ethanol)
Ethylenediamine	Ethylene glycol	Fish oil

Fluorolube	Freon T-P35	Fyrquel (Cellulube)
Gelatine	Glucose (dextrose)	Glycerine (Glycerol, oil sweet; E422)
Glycol (1,2-diol)	Green sulphate broth	Blast furnace gas
Isobutyl alcohol (isobutanol)	Isopropyl alcohol (isopropanol)	Potassium chloride (aqueous solution)
Potassium cyanide (aqueous solution)	Potassium dichromate (aqueous solution)	Potassium copper cyanide (aqueous solution)
Potassium nitrate (aqueous solution)	Potassium sulphate (aqueous solution)	Lime-Sulphur Solution
Carbon dioxide	Carbon monoxide	Coconut oil
Copper chloride (aqueous solution)	Copper cyanide (aqueous solution)	Copper sulphate (aqueous solution)
Glue (DIN 16920)	Linseed oil	Magnesium chloride (aqueous solution)
Magnesium sulphate (aqueous solution)	Maize oil	Methyl alcohol (methanol)
Methyl ether (dimethyl ether)	Milk	Lactic acid (cold)
Monomethyl ether	Sodium borate (aqueous solution)	
Sodium bicarbonate (aqueous solution)	Sodium bisulphite (aqueous solution)	Sodium chloride (aqueous solution)
Sodium cyanide (aqueous solution)	Sodium sulphate (aqueous solution)	Sodium thiosulphate (aqueous solution)
Nickel chloride (aqueous solution)	Nickel sulphate (aqueous solution)	Ozone
Propyl alcohol (propanol)	Castor oil	Cane sugar liquid
Beet sugar liquid	Sacharose solution (cane sugar)	Salt water
Oxygen (cold)	Soap solution	Mustard gas
Silver nitrate	Soda ash, free of water of crystallisation	Soya oil (soybean oil)
Spirit	Nitrogen	Water
Tartaric acid	Whiskey and wine	Zinc chloride (aqueous solution)
Zinc sulphate (aqueous solution)	Citric acid	

Minor to moderate change in properties		
Waste water (according to DIN 4045)	Acetaldehyde	Acetamide (acetic acid amide)
Acetylene (ethyne)	Acrylic acid ethyl ester	Aluminium chloride (aqueous solution)
Aluminium chloride (aqueous solution)	Aluminium fluoride (aqueous solution)	Aluminium nitrate (aqueous solution)
Formic acid (methanoic acid)	Ammonium nitrite (aqueous solution)	Malic acid
Benzaldehyde (artificial bitter almond oil)	Benzyl alcohol	Bleach solution
Lead nitrate (aqueous solution)	Lead sulphamate (aqueous solution)	Borax solution (disodium tetraborate)
Bordeaux blend	Bunker oil	Butter (animal fat)
Butyl alcohol (butanol)	Calcium hypochlorite (aqueous solution)	Calcium nitrate (aqueous solution)
Calcium sulphide (aqueous solution)	Carbitol (ethyl diglycol)	Chlorox (sodium hypochlorite)
Decan	Diacetone alcohol (Diacetol)	Dibutyl phthalate (DBP)
Dibutyl sebacate (DBS)	Diethylamine	Diethylene glycol (digol)
Diethylsebacate	Dimethylformamide (DMF)	Iron(III) chloride (aqueous solution)
Iron(III) sulphate (aqueous solution)	Acetic acid, glacial acetic acid	Ethanolamine (aminoethanol) (MEA)
Ethyl acetate (ethyl acetate)	Ethyl acetoacetate	Formaldehyde (RT) (methanal)
Fumaric acid	Generator gas	Tannic acid (tannin)
n-Hexaldehyde	Hexanol	Cod liver oil
Lime bleach	Cobalt dichloride (aqueous solution)	Carbon dioxide
Coke oven gas	Lard (animal fat)	Lye (alkali lye)
Linoleic acid	Lactic acid (hot)	Mineral oil
Monoethanolamine	Sodium hydroxide (aqueous solution)	Sodium hypochlorite (aqueous solution)
Sodium perborate (aqueous solution)	Octyl alcohol (octanol)	Oxalic acid (ethanedioic acid, clover acid)
Petroleum (< 121°C)	Vegetable oil	Phosphoric acid (20%)
Pyrrrole	Salmiak (ammonium chloride)	Nitric acid (diluted)
Oxygen (93 - 204 °C)	Sulphur dioxide (liquid under pressure)	Sulphur dioxide (wet)
Sulphur dioxide (dry)	Sulphur hexafluoride	Sulphur trioxide
Stearic acid (octadecanoic acid)	Tar, Bituminous	Animal fats
Transformer oil	Chrome plating solution	Hydrogen peroxide (90%)

Tin dichloride (aqueous solution)	Tin tetrachloride (aqueous solution)	
--------------------------------------	---	--

Moderate to strong change of properties		
Acetone	Acetyl chloride (acetic acid chloride)	Ammonia, anhydrous
Aniline dye	Benzoic acid (E 210)	Hydrogen cyanide
Chromic acid	Dibenzyl sebacate	Dibutylamine
Diocetyl phthalate (DOP)	Diocetyl sebacate (DOS)	Diphenyl oxide
Dowtherm oil	Iron(III) nitrate (aqueous solution)	Acetic anhydride
Ethyl cellulose	Ethylene chlorohydrin	Ethyl mercaptan (ethanethiol)
Fatty acids	Freon TA	Freon TMC
Hydraulic oils (mineral oil based)	Hydrazine (diamide, diazane)	Potassium hydroxide (aqueous solution)
Lindol (hydraulic fluid)	Methyl butyl ketone (propylacetone)	Olive oil
Petroleum gas, liquid (LPG)	Phosphoric acid (45%)	Propyl acetone (methyl butyl ketone)
Hydrochloric acid (cold) 37	Sulphur	Sulphur chloride (aqueous solution)
Hydrogen sulphide (wet, cold)	Hydrogen sulphide (wet, hot)	Silicone grease
Radiation	Tricresyl phosphate (TCP)	Triocetyl phosphate
Water vapour (< 149 °C)	Hydrogen gas	

Not recommended		
Acetophenone	Acrylonitrile	Aluminium acetate (aqueous solution)
Amylacetate (acetic acid amyl ester)	Amyl alcohol (pentanol)	Amylchloronaphthalene
Amylnaphthalene	Aniline (aminobenzene)	Aniline hydrochloride
Asphalt	Banana oil (amyl acetate)	Pickling solution
Petrol (nitrobenzene, ligroine)	Benzene	Benzenesulfonic acid
Benzyl chloride	Biphenyl (diphenyl, phenylbenzene)	Lead acetate (aqueous solution)
Bromine, anhydrous	Bromobenzene	Bromine trifluoride
Bromine water	Hydrobromic acid	Hydrobromic acid (40%)
Butadiene	Butane	Butyl acetate (acetic acid butyl ester)
Butylamine	Butylene (Buten)	Butylethyldiglycol (CARBITOL)
Butyraldehyde (Butanal)	Calcium acetate (aqueous solution)	Carbolic acid (phenol)
Cellosolve (ethylene glycol ether)	Cellosolve acetate (glycol acetate)	China Wood Oil (China Tung Oil)

Chlorine, wet	Chlorine, dry	1-Chloro-1-nitroethane
Chloroacetone	Chlorobenzene	Bromochloromethane
Chlordodecane	o-Chlornaphthalene	Chloroform (trichloromethane)
Chloroprene (chlorobutadiene)	Chlorosulphuric acid (chlorosulphonic acid)	Chlorotoluene
Chlorine trifluoride	Cumene (Isopropylbenzene)	Cyclohexane (hexamethylene)
Cyclohexanol (hexahydrophenol, anol)	Cyclohexanone (Pimelin Ketone, Anon)	p-Cymene (Cymol)
Decalin (decahydronaphthalene)	Diacetone	Dibromoethylbenzene
Dibutyl ether	o-Dichlorobenzene	Dichloroisopropyl ether
Diesel oil	Diethylbenzene	Diisobutylene (Isooctene)
Diisopropyl ketone	Diisopropylidene acetone (Phoron)	Dimethylaniline (xylydine, aminoxylol)
Dinitrotoluene (DNT)	Dioxane	Dioxolan (glycol methyl ether)
Dipentene (paint solvent)	Diphenyl (biphenyl, phenylbenzene)	Epichlorohydrin
Ethan	Ethyl benzoate	Ethylbenzene
Ethyl cellosolve (glycol diethyl ether)	Ethyl chlorocarbonate	Ethyl chloroformate
Ethyl chloride (chloroethane)	Ethylene chloride	Ethylene dichloride (1,2-dichloroethane)
Ethylene oxide (oxirane, epoxy)	Ethylene trichloride	Ethyl ether (diethyl ether)
Ethyl oxalate	Ethylpentachlorobenzene	Fluorine (liquid)
Fluorobenzene	Hydrofluoric acid, conc. (cold)	Hydrofluoric acid, conc. (hot)
Hydrofluoric acid, anhydrous	Freon 11 (trichlorofluoromethane)	Freon 12 (dichlorodifluoromethane)
Freon 13 (chlorotrifluoromethane)	Freon 13B1	Freon 21 (dichlorofluoromethane)
Freon 22 (chlorodifluoromethane)	Freon 112	Freon 113 (trichlorotrifluoroethane)
Freon 114 (dichlorotetrafluoroethane)	Freon 114B2	Freon BF
Freon MF	Freon TC	Freon TF
Freon T-WD602	Furfural (Furfurol)	Electroplating solution for chrome
Galvanising solution for other metals	Halowax oil	Hexafluorosilicic acid
Hexane	n witches-1	Iodine pentafluoride
Isooctane	Isophorone	Isopropyl acetate
Isopropyl chloride	Isopropyl ether	Potassium acetate (aqueous solution)

Paraffin (illuminating petroleum; DIN 51636)	Carbon disulphide (carbon disulphide)	Carbon tetrachloride
Coal tar (creosote)	Aqua regia	Creole acid
Creosote coal tar	Kresol (methylphenol)	Copper acetate (aqueous solution)
Lacquer	Lacquer (cellulose lacquer)	Lacquer (solvent)
Lavender oil	Ligroin (nitrobenzene)	Mesityl oxide
Methane	Methyl acetate (methyl acetate)	Methyl acrylate
Methyl cellosolve (methylene glycol ether)	Methyl chloride (monochloromethane)	Methylene chloride (dichloromethane)
Methyl ethyl ketone (MEK)	Methyl isobutyl ketone (MIBK)	Methyl methacrylate (MMA)
Methylpentane	Monochlorobenzene	Naphtha
Naphthalene (naphthalene)	Naphthenic acid	Sodium acetate (aqueous solution)
Sodium nitrate (aqueous solution)	Sodium peroxide (aqueous solution)	Sodium phosphate (aqueous solution)
Neville Winther Acid	Nickel acetate (aqueous solution)	Nitrobenzene
Nitrobenzene (petroleum ether)	Nitroethane	Nitromethane
Octachlorotoluene	Octadecan	n-octane
Oleic acid	Palmitic acid (n-hexadecanoic acid)	Paraffin oil (white oil)
Perchloric acid	Petroleum (> 121°C)	Phenol (carbolic acid)
Phenylbenzene	Phenylethylether	Phoron (diisopropylidene acetone)
Picric acid (2,4,6-trinitrophenol)	Pinen	Piperidine (hexahydropyridine)
Propane	i-Propyl acetate	n-Propyl acetate (acetic acid propyl ester)
Propyl nitrate	Propylene (propene)	Propylene oxide
Pyridine	Rapeseed oil	RJ-1 (Mil-F-25558B)
RP-1 (Mil-R-25576C)	Nitric acid (concentrated)	Nitric acid (red, fuming)
Hydrochloric acid (hot) 37	Lubricating oil, petroleum	Sulphuric acid (20% oleum)
Sulphuric acid (diluted)	Sulphuric acid (concentrated)	sulphurous acid
Silicate ester	Nitrogen tetroxide	Styrene, monomer (phenylethylene)
Sulphite lye	Turpentine	Tetrabromoethane
Tetrabromomethane (carbon tetrabromide)	Tetrachloroethylene (Per)	Tetrahydrofuran (THF)
Tetralin (tetrahydronaphthalene)	Titanium tetrachloride	Toluene diisocyanate (TDI)

Toluene (methylbenzene)	Fuel oil	Tributyl mercaptan
Tributyl phosphate (TBP)	Trichloroethane	Trichloroethylene (Trichloroethene, Tri) (TCE)
Tung oil (China wood oil)	Turbine oil	Unsymmetrical dimethylhydrazine (UDMH)
Water vapour (> 149 °C)	Xylene (xylene, dimethylbenzene)	Xylidine (aminoxylene, dimethylaniline)
Zinc acetate (aqueous solution)		

Other properties

Property	Typical value	Test method
Hardness	Shore A 50 ± 5	ASTM D 2240
Compression set (24 h / 175 °C)	18%	ASTM D 395/B
Operating temperature (air)	-50 °C to +190 °C	
Flame class	V-0	UL 94 / IEC 60695-11-10

22.1.1.4 Front plate foil

The front plate foil contains a UV-absorbing chemical that greatly increases resistance to yellowing and premature embrittlement in outdoor applications.

With continuous contact with chemicals, some chemicals begin to remove the UV absorber, reducing its UV resistance.

The front plate foil will withstand exposure to the following chemicals for 5 hours without significant visible change or loss of UV resistance. For longer durations, both the visual appearance (colour) and UV resistance may be affected.

Resistance of 5 hours				
Diesel	Ammonia 2 % *	Acetic acid 5 %	Cutting oil	Hydraulic oil
Glycerine	Sodium hydroxide *	Hydrochloric acid 10 %	Paraffin oil	Salt water
White spirit *	Potassium carbonate solution *	Nitric acid 10 %	Pure turpentine	Water
SBP 60/95 *	Potassium ferricyanide	Phosphoric acid ≥ 30 %	Linseed oil	
Spirit	Sodium carbonate solution *	Sulphuric acid 10 %	Castor oil	

* Extremely faint texture sheen was noted on contact with these chemicals.

Contact with the following chemicals under the above conditions will result in a slight sheen to the texture and a reduction in the UV resistance of the product.

Chemicals		
1.1.1. trichloroethane *	Ethyl acetate	Methanol
Acetaldehyde	Formaldehyde solution	Methyl ethyl ketone
Acetone	Formic acid 50 %	Toluene *
Cyclohexanol	Glycol	Xylene *
Cyclohexanone	Industrial methylated spirit	
Ether	Isopropyl	

* A white stain was observed on the film surface upon contact with these chemicals.

The front panel film withstands exposure to the following household chemicals for 5 hours at 50 °C.

Chemicals		
Bleach / Toilet Cleaner	Cleaner for hard surfaces	Cleaning fluid
Cream cleanser	Washing powder solutions	Window cleaner
Fabric softener	Washing-up liquid	Tomato ketchup

The front panel film is **NOT** resistant to the following chemicals:

Chemicals		
Benzyl alcohol	Concentrated mineral acids	High pressure steam above 100 °C
concentrated lye	Methylene chloride	

More features

Property	Typical value	Test method
Haze: Fine Velvety	58% ± 5% 71% ± 5%	ASTM D1003
Total light transmittance	92% ± 2%	ASTM D1003
Gloss level (60°): Fine Velvety	7 ± 1.5 GU 4.5 ± 1 GU	ASTM D2457 (modified according to test method 022)
Yellowness index	< 5	ASTM E313
Adhesion of the hard coating	passed	Test method 080
Lifetime	> 5 million operations	Test method 003
Tensile strength at break	172 – 190 N/mm ²	ASTM D882
Breakdown voltage: 150 µm 200 µm	16 - 18 kV 18 - 20 kV	ASTM D149
Dimensional stability	0.2% maximum shrinkage MD at 120 °C	Test method 094
Thickness all types	Nominal ± 10%	Test method 096
Maximum processing temperature	120 °C	
Maximum operating temperature (Low humidity < 10% RH)	85 °C	Test method 012
Maximum operating temperature (High humidity 85% RH)	85 °C	Test method 012
Minimum operating temperature	-40 °C	Test method 012

22.1.1.5 Front glass

Glass has a fairly high resistance to most liquids or gases. Only hydrofluoric acid is able to attack glass. A reaction occurs when aqueous solutions come into contact with the glass surface.

Characteristics

- unadulterated colour perception
- reflection-free view
- improved light transmittance
- hard, corrosion-resistant multi-layer coating

23 Appendix G

23.1 Defective pixels

As a result of the manufacturing process (production tolerances and errors) for the displays they may be delivered with defective pixels. These potential defective pixels are not a display or HMI error or defect, provided they are within the range of the specification below.

23.1.1 Terminology

Defective pixels Pixels or sub-pixels that do not perform as expected and are either always on or always off

Pixel Image point on the display consisting of 3 sub-pixels in the basic colours red, green and blue



Dot Sub-pixel in the basic colour red, green or blue



Bright Sub-pixel (dot) to which light is passing through, creating a bright dot that is on

Dark Sub-pixel (dot) to which no light is passing through, creating a dark dot that is off

Adjacent dots Dots positioned next to one another, horizontally, vertically or diagonally, bright or dark (e.g. the following pattern and sub-pixels)

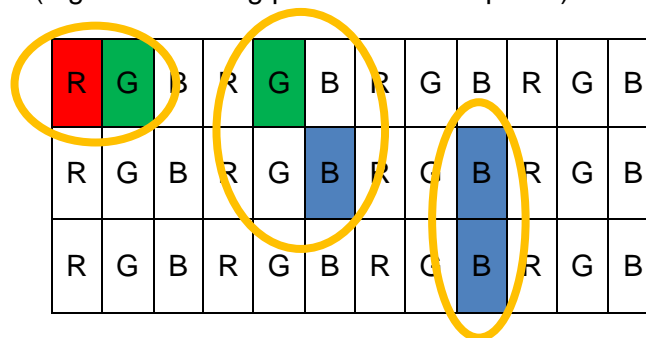

Distance between Dots Definition of distance between two defective dots horizontal, vertical or diagonal, bright or dark (e.g. the following pattern and sub-pixels)

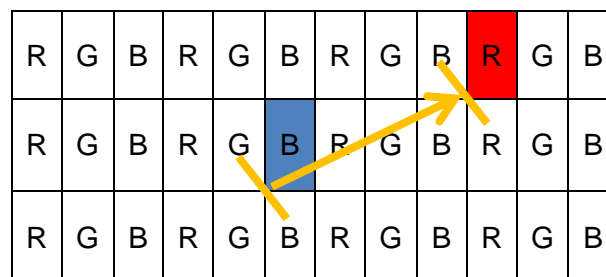

23.1.2 Display specification

Type of defect / description	max. number of permitted defects		
	12" display	15" display	22" display
Linear defect (horizontal, vertical)	not acceptable		
Defective pixels			
bright dots	≤ 2	≤ 2	≤ 2
dark dots	≤ 3	≤ 3	≤ 5
total number of dots	≤ 3	≤ 5	≤ 5
adjacent dots			
2 bright dots	≤ 0 pairs	≤ 1 pairs	≤ 1 pairs
more than 3 bright dots	not acceptable		
2 dark dots	≤ 1 pairs	≤ 1 pairs	≤ 2 pairs
more than 3 dark dots	not acceptable		
Distance between the dots			
between 2 bright dots	not defined	not defined	not defined
between 2 dark dots	not defined	not defined	not defined
between 1 bright and 1 dark dot	not defined	not defined	not defined
ND filter for mura effects, bright and dark dots	not defined	not defined	5 %

23.2 Optical specification front glass

For glass with a surface of $>0.1\text{m}^2$ to $\leq 0.35\text{ m}^2$

Type of defect / description	Value	Corresponds to specification on the basis of DIN10110
Largest point defect	max. 0.4 mm^2	0.63 - 1 mm
max. number		7
additional small point defects	max. $0.16 - 0.4\text{ mm}^2$	0.4 - 0.63 mm
max. number		7
In general, any number of point defects smaller than the following specified surface are always permitted, that is, they are not considered to be defects.		
Surface	$< 0.16\text{ mm}^2$	$< 0.4\text{ mm}$
Scratches		
max. Width		0.16 mm
max. Number		7
max. Length		42 mm
Cumulative length of all scratches		42 mm
In general, any number of scratches narrower than the following specified width are always permitted, that is, they are not considered to be defects.		
Width		$< 0.16\text{ mm}$
Minimum distance of defects		70 mm



The defect sizes are listed here as the square root of the surface in mm.

$$\text{Defect size} = \sqrt{\text{defect length} * \text{defect width}}$$

23.2.1 Test criteria

Test setup: transmitted light / transmission

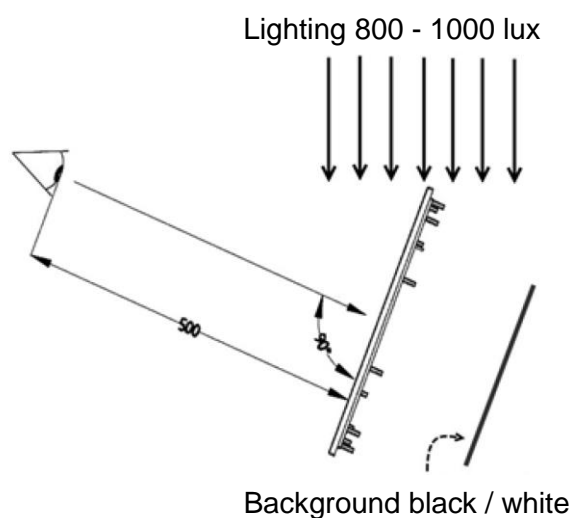

Test setup: Reflexion

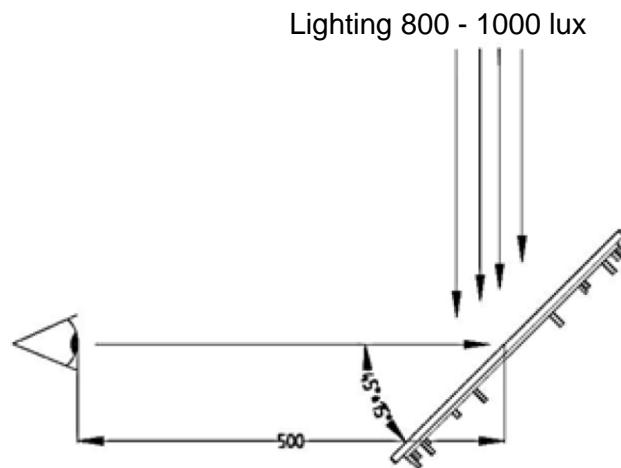

Tester	Trained, experienced person with normal eyesight
Distance tester to tested object	500 mm
Viewing angle (to surface)	
for transmitted light / transmission	90°
for reflexion	30° - 60°
Lighting	Standard, 800 - 1000 lx standard D50 or D65 light
Test light density	Light table with 500 lux

23.3 Optical acceptance of surfaces

This section covers the acceptance criteria applicable to the minimum requirements for surfaces of devices and components.

The values for imperfection types listed under "tolerance limits" do not constitute a defect or an imperfection of the device or component and must therefore be tolerated.

23.3.1 Optical acceptance glass

Imperfection type	Criterion	Tolerance limits
Total imperfections	Number	max. 3
Cleanness of glass surface	Clearly visible dirt	not permitted
Edge crack / incipient crack	Visible	not permitted
Scratches	Width	up to 0.16 mm
	Length	up to 40 mm
	Cumulative length of all scratches	max. 40 mm
	Long side of glass < 300 mm, distance > 70 mm	
	Number	2
	Long side of glass 300 - 600 mm, distance > 70 mm	
	Number	3
Hairline scratches / scraper damage	Width	max. 0.05 mm
	Length	max. 40 mm
Large point defects	Size	max. 0.4 mm ²
	Number	2
Small point defects	Size	max. 0.16 - 0.4 mm ²
	Number	5
Permitted point defects	Size	< 0.16 mm ² , provided there is no cluster ***
Interference points	Ø < 0.2 mm	Permitted
	0.2 mm < Ø ≤ 0.6 mm	Permitted provided there is no cluster ***
	0.6 mm < Ø ≤ 1.3 mm	5
	1.3 mm < Ø ≤ 2.0 mm	2
	Ø > 2.0 mm	not permitted
Inhomogeneity *	Minor colour variations	Permitted
White haze **	Only visible in reflection	Permitted
	Not visible when device is in operating position.	Permitted



* In the case of coated float glass, inhomogeneity in the form of minor colour variations can occur and cannot be prevented by any technical means.

** Large, cloudy blemish can be more pronounced towards the centre of the glass, but can also affect larger parts of the glass.

*** A cluster is an accumulation of more than 7 disregarded, permitted imperfections that occur within an inspected area of a diameter of 40 mm.

23.3.2 Optical acceptance printing

Description	Tolerance limits
Labelling	Clearly legible, minimum stroke weight 0.3 mm
Characters	Clearly legible
Lines and symbols	Interruptions not permitted
Ink coverage	Sufficient if underlying layers and structures not visible
Acutance	+/- 0.15 mm
Edge blurring	+/- 0.15 mm
Print overlap	Possible colour variations in the overlap area are permitted
Variations of stroke weight	10 %
Within a shaping print	"Fine" as specified in DIN ISO 2768-1 General tolerance class
Between shaping prints	< 400 mm +/- 0.3 mm ≥ 400 mm +/- 0.5 mm

Imperfection type	Criterion	Tolerance limits
Dirt and dust particle inclusions, stains, fluff,	Size	max. 0.16 mm ²
	Size for weak colour contrast	max. 0.25 mm ²
	Number / 100 cm ²	1
	Minimum distance	80 mm
	Lower limit	0.063 mm ²





23.3.3 Optical acceptance, other surfaces

Definitions

Scratch	straight or curved / wavy surface damage
Dents / dings	plastic deformation inwards or outwards
Scuff mark without dent	"punch mark"-type depression

Surface categories

If not specified otherwise in the drawing, the following applies:

A surface	Surface is frequently viewed, typically the front plate. Surface is in customer's field of vision
	Colour code 
B surface	Surface is occasionally viewed, typically the sides of the device
	Colour code 
C surface	Surface is rarely viewed, typically the back or bottom of device
	Colour code 
D surface	Surface is never viewed, typically the inside of the device
	Colour code 

Accessories such as stand, wall bracket etc. are termed C surfaces



Imperfection type	A surface	B surface	C surface	D surface
Scratches	max. 1 per side	max. 2 per side	1x up to 100 mm with the grain	permitted
	0.05 – 0.1 mm wide and max. 10 mm long	0.05 – 0.1 mm wide and max. 10 mm long		
	or	or	and	
	0.01 – 0.05 mm wide and max. 40 mm long	0.01 – 0.05 mm wide and max. 40 mm long	3x up to 15 mm against the grain	
	only with the grain	only with the grain	1x up to 30 mm against the grain	
Gouges, depressions (punch-mark-type depression)	not permitted	not permitted	max. 2 per side max. 0.3 mm wide max. 3 mm long	permitted
Dents / cavities	not permitted	not permitted	not permitted	not permitted
Welding flaws	not permitted	not permitted	not permitted	not permitted
Chatter marks	not permitted	not permitted	not permitted	not permitted
Material flaws	not permitted	not permitted	not permitted	not permitted
Orange peel: surface not homogeneous	not permitted	not permitted	not permitted	permitted

24 Appendix H

24.1 Control Drawing

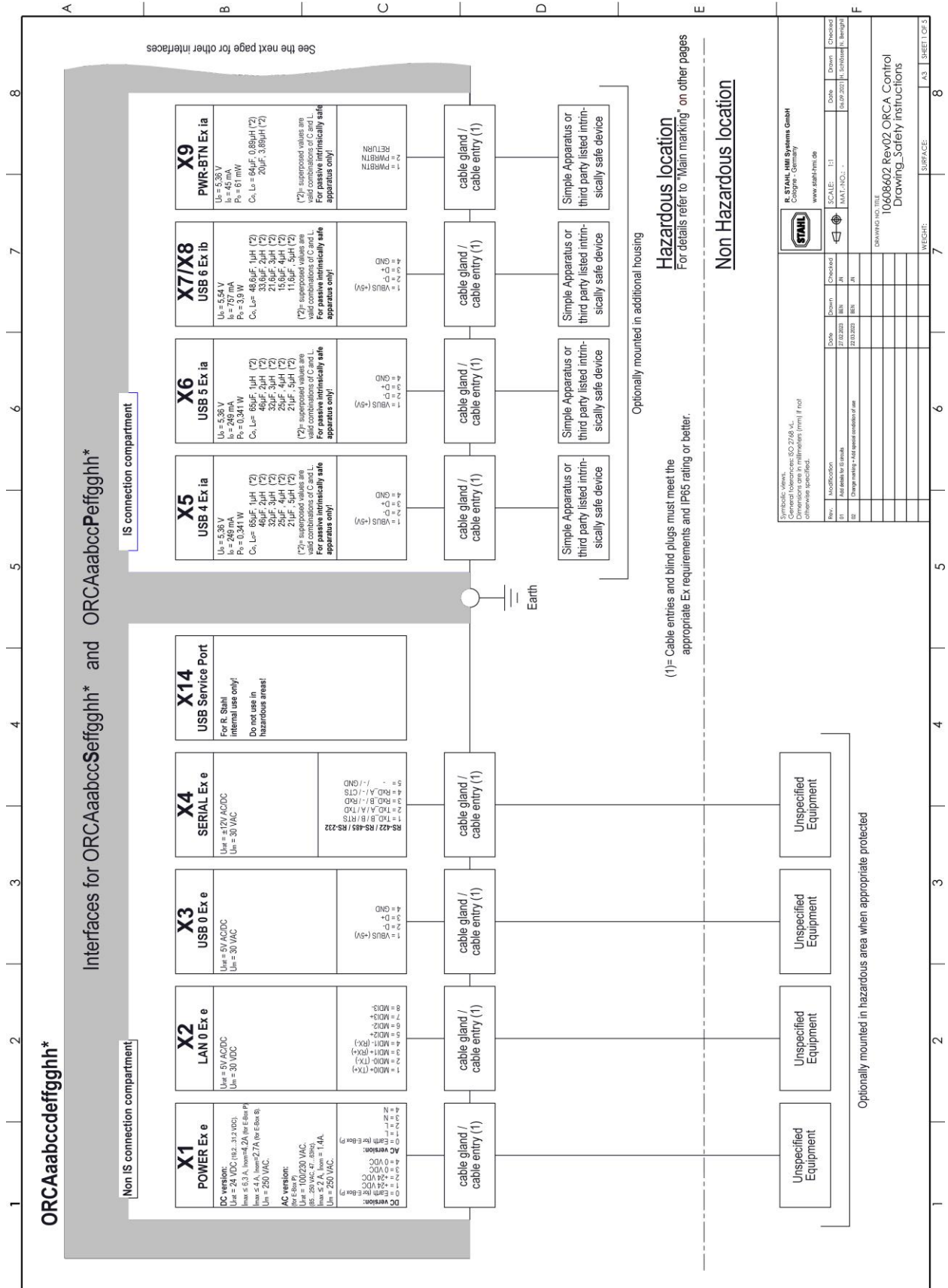

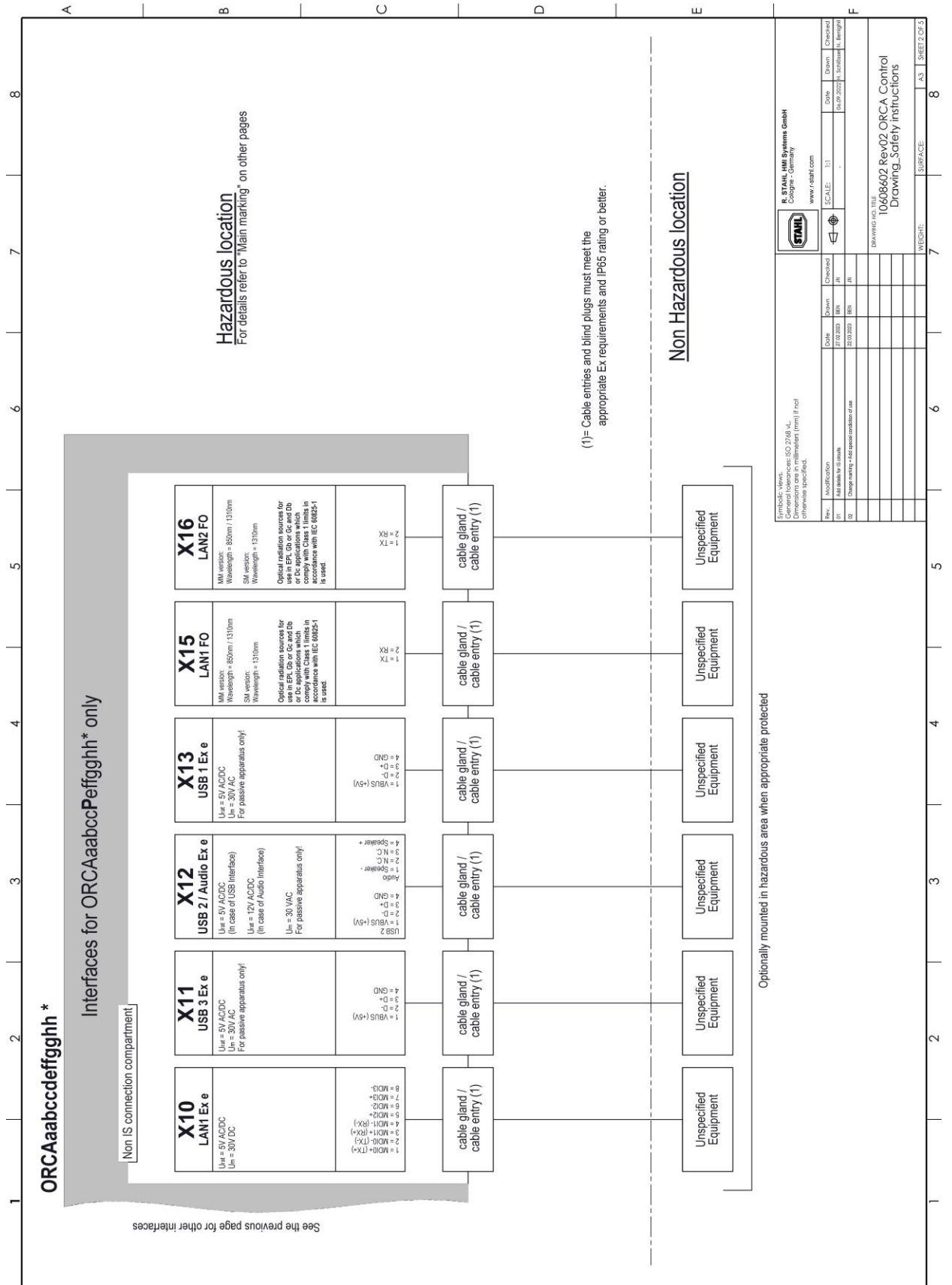

Details and instructions:

- The ORCA is an explosion-protected device for installation in hazardous areas and can be operated in areas as noted on the device.
- The ORCA may only be installed and operated in an undamaged, dry and clean condition! Any damage may compromise the explosion protection!
- The national assembly and installation rules and the generally accepted technical rules must be observed. The device and its accessories must be connected and operated according to applicable standards, directives and installation guidelines. Only qualified personnel or personnel that has been instructed accordingly are allowed to install the device.
- The intrinsically safe circuits do not satisfy the 500 V dielectric with respect to earth. The GND of intrinsically safe circuits are connected to earth.
- Copper cables (solid or flexible) for field wiring at terminal blocks X1, X2, X3, X4, X5, X6, X7, X9, X10, X11, X12 and X13 may be used with the cross sections between 0.2 mm² (AWG24) and 2.5 mm² (AWG14).
- Two conductors with the same cross section and conductor type) with the cross sections between 0.2mm² (AWG24) and 0.75 mm² (AWG18) may be used also.
- Conductor cross section flexible with ferrule with or without plastic sleeve between 0.25mm² (AWG24) and 1.5mm² (AWG16).
- Two conductors with same cross section, stranded, with ferrule without plastic sleeve.
- Stripping length 9mm.
- The terminal blocks require a tightening torque of 0.4 Nm ... 0.5 Nm.
- Cable glands or other equipment (e.g. cable connector, buttons...) used in the threads of the connection compartment, must be suitable and certified for the area of installation and adjusted if necessary. Herewith possible changing of the ambient parameters e.g. like ambient temperature range must be observed. Thread sizes E-Box P: 1x M20x1.5, 3x M20x1.5, 7x M16x1.5, E-Box S: 2x M20x1.5, 5x M16x1.5. Optional pre mounted cable glands suitable for cable diameter range M25 = 14...18mm, M20 = 6...12mm, M16 = 4...8 mm. The tightening torques for the cable glands may vary depending on the cables and wires used. The users have to determine and apply the required torques themselves. Optional pre mounted cable glands for use with non-armored cables. Not used cable glands must be closed with suitable blind plugs or replaced by suitable blind plugs.
- The device has to be installed in such a way that mechanical effects (pulling forces) on the cables are excluded. The cable has to be fixed and effectively protected against damage.
- For ATEX/IECEx: Only permanently laid cables may be connected to the optional pre-mounted cable glands.
- The temperature rating of the cables and cable entries to be used must be appropriate for the ambient temperature of the installation:
For -20 °C < Ta ≤ +30 °C: cables and cable gland/entries approved for at least 70 °C
For +30 °C < Ta ≤ +55 °C: cables and cable gland/entries approved for at least 95 °C
- The following special conditions of use are actually listed on the certificates of the following accessories: they must be taken into account if they are installed with ORCA:
 - The Hummel AG cable glands Series HSK-K-MZ-Ex were tested for low risk of mechanical danger and shall be protected against higher impact energy levels.
 - The CMP Products Type 737 non-metallic adaptors or reducers shall only be used with non-metallic cable glands.

- The earth / ground (equipotential bonding) connector at the back of the ORCA E-Box must be connected to the equipotential bonding conductor of the hazardous area. The earth cable must have a minimum cross section of 4 mm² and be fitted properly.
- A rating of 250V / 17A must be ensured at place of installation.
- For ORCA01M only: The equipment is intended for installation in an area providing at least pollution degree 2, as defined in IEC 60664-1. Transient protection shall be provided that is set at a level not exceeding 140% of the peak rated voltage value at the supply terminals to the equipment.
- Ambient rating -20°C<Tas<+55°C at place of installation. Rel. humidity 90% at 40 °C without condensation. Altitude up to 2000m. Outdoor use. Type of protection IP65. The device may be installed and operated in any position.
- Panel mount: Put device through cut out matching to D-Box size. Slide mounting frame from rear side over ORCA and fix with mounting screws (torque 3.5 - 7.5 Nm) like shown at control drawing.
- The devices are suitable for installation into the cutout of an enclosure with IP65 according to IEC 60079-0, resp. into the cutout of an enclosure type of protection Ex eb resp. ec or EX tb resp. tc or Ex p. They fulfill the respective enclosure requirements.
- Torque for connection compartment screws: 3.5 - 7.5 Nm. Torque to mount E-Box and D-Box together (for service purposes): 3.5 - 7.5 Nm.
- Only appropriate tools must be used for the installation.
- If the equipment is used in a manner not specified by the manufacturer, the protection provided by the equipment may be impaired.
- Keep unit free of decontaminations. Use suitable cleaning agents for cleaning. Do not use aggressive or abrasive agents.
- System maintenance should focus on the following: Seal wear. Damage to front screen / glass. All screws are tightened properly. All cables and lines are properly connected and undamaged.
- Any repairs must always be carried out by the manufacturer.

A 1 2 3 4 5 6 7 8 B C D E F

Alle Rechte vorbehalten | Diese Zeichnung darf ohne unsere ausdrückliche Zustimmung Empfänger oder durch Dritte nicht in anderer Art und Weise mitdrücklich vervielfältigt werden. Stand der Technik – Technische bzw. konstruktive Änderungen vorbehalten.

STAHL HMI Systems GmbH Glogner-Str. 1 42699 Solingen www.stahl-hmi.de		Symbolic Views: General tolerances: ISO 2768 M, Dimensions are in millimeters (mm) if not otherwise specified.			
Rev.	1	Modification	Date	Drawn	Checked
01	1.00	1st release for release	27.03.2023	BN	JN
02	1.01	Change marking - Add special condition of use	27.03.2023	BN	JN
SCALE: 1:1		DATE: 26.09.2024		SCALE: 1:1	DATE: 26.09.2024
DRAWING TITLE		SURFACE		SHEET 3 OF 5	
10608602 Rev02 ORCA Control		DRAWING NO.		10608602 Rev02 ORCA Control	
Drawing_Safety Instructions		WEGE:		SURFACE	

A	B	C	D	E	F
1	2	3	4	5	6
7	8	9	10	11	12
13	14	15	16	17	18
19	20	21	22	23	24
25	26	27	28	29	30
31	32	33	34	35	36
37	38	39	40	41	42
43	44	45	46	47	48
49	50	51	52	53	54
55	56	57	58	59	60
61	62	63	64	65	66
67	68	69	70	71	72
73	74	75	76	77	78
79	80	81	82	83	84
85	86	87	88	89	90
91	92	93	94	95	96
97	98	99	100	101	102
103	104	105	106	107	108
109	110	111	112	113	114
115	116	117	118	119	120
121	122	123	124	125	126
127	128	129	130	131	132
133	134	135	136	137	138
139	140	141	142	143	144
145	146	147	148	149	150
151	152	153	154	155	156
157	158	159	160	161	162
163	164	165	166	167	168
169	170	171	172	173	174
175	176	177	178	179	180
181	182	183	184	185	186
187	188	189	190	191	192
193	194	195	196	197	198
199	200	201	202	203	204
205	206	207	208	209	210
211	212	213	214	215	216
217	218	219	220	221	222
223	224	225	226	227	228
229	230	231	232	233	234
235	236	237	238	239	240
241	242	243	244	245	246
247	248	249	250	251	252
253	254	255	256	257	258
259	260	261	262	263	264
265	266	267	268	269	270
271	272	273	274	275	276
277	278	279	280	281	282
283	284	285	286	287	288
289	290	291	292	293	294
295	296	297	298	299	300
301	302	303	304	305	306
307	308	309	310	311	312
313	314	315	316	317	318
319	320	321	322	323	324
325	326	327	328	329	330
331	332	333	334	335	336
337	338	339	340	341	342
343	344	345	346	347	348
349	350	351	352	353	354
355	356	357	358	359	360
361	362	363	364	365	366
367	368	369	370	371	372
373	374	375	376	377	378
379	380	381	382	383	384
385	386	387	388	389	390
391	392	393	394	395	396
397	398	399	400	401	402
403	404	405	406	407	408
409	410	411	412	413	414
415	41				

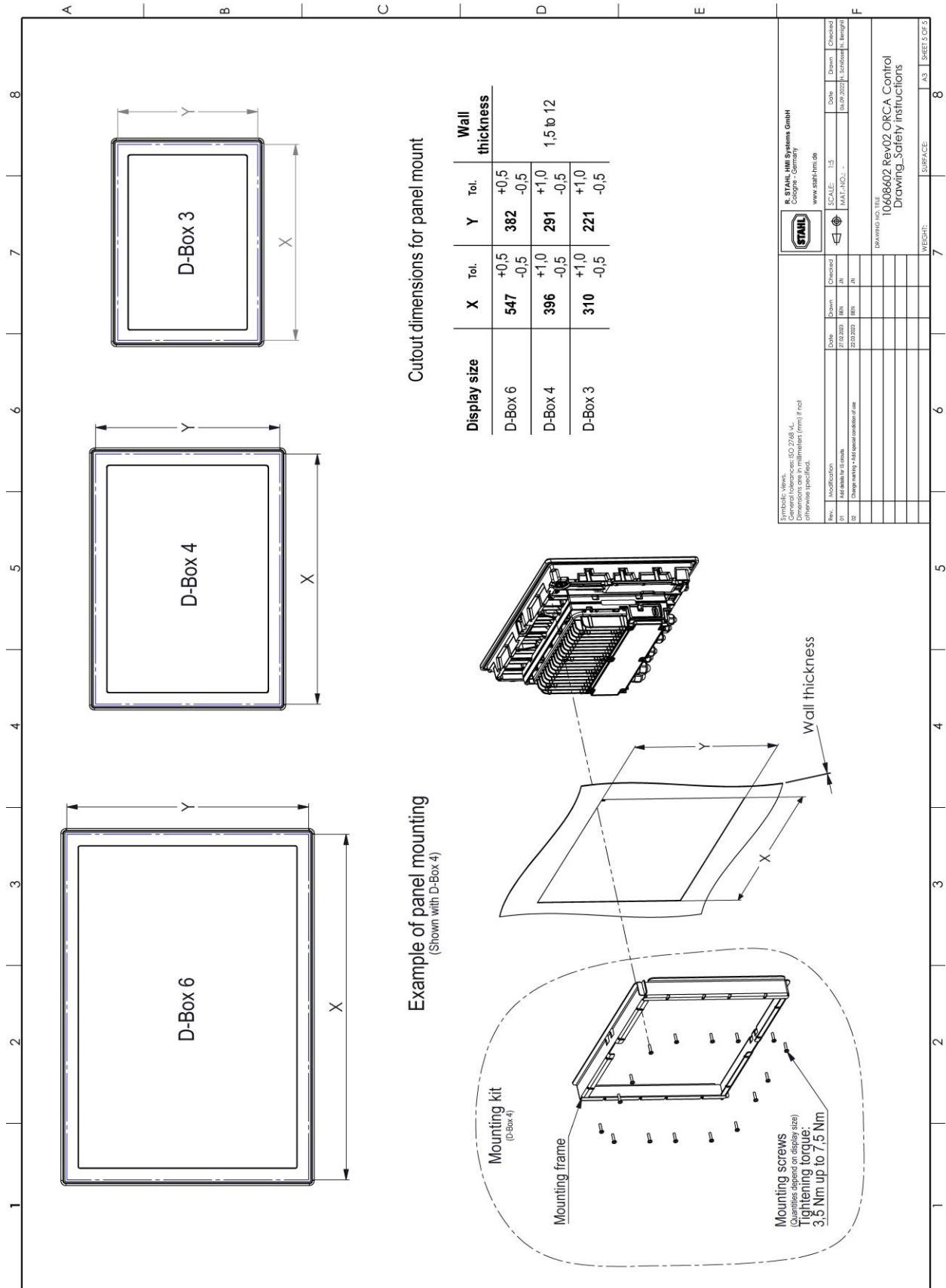

25 Appendix I

25.1 Declarations of conformity

25.1.1 EU

25.1.1.1 ORCA01E

EU Konformitätserklärung EU Declaration of Conformity Déclaration de Conformité UE



R. STAHL HMI Systems GmbH • Adolf-Grimme-Allee 8 • 50829 Köln, Germany
erklärt in alleiniger Verantwortung, declares in ist sole responsibility, déclare sous sa seule responsabilité,

dass das Produkt: **Bedien- und Beobachtungsgeräte**
that the product: **Operating and Monitoring Devices**
que le produit: **Moniteur de commande et de visualisation**

Typ(en), type(s), type(s): **ORCA01ETCS3..., ORCA01ETCP3 ...**
ORCA01ETCS4..., ORCA01ETCP4 ...
ORCA01ETCS6..., ORCA01ETCP6 ...

mit den Anforderungen der folgenden Richtlinien und Normen übereinstimmt.
is in conformity with the requirements of the following directives and standards.
est conforme aux exigences des directives et des normes suivantes.

Richtlinie(n) / Directive(s) / Directive(s)	Norm(en) / Standard(s) / Norme(s)
2014/34/EU ATEX-Richtlinie 2014/34/EU ATEX Directive 2014/34/UE Directive ATEX <i>Official Journal of the EU L96, 29/03/2014, p. 309–356</i>	EN IEC 60079-0:2018 EN 60079-5:2015 EN IEC 60079-7: 2015 + A1:2018 EN 60079-11:2012 EN 60079-31:2014
Kennzeichnung, marking, marquage:	II 2(1) G Ex eb ib qb [ib] [ia Ga] IIC T4 Gb II 2(1) D Ex tb [ib] [ia Da] IIIC T115°C Db
EU Baumusterprüfbescheinigung: EU Type Examination Certificate: Attestation d'examen UE de type:	UL 23 ATEX 2902X (UL International Demko A/S Borupvang 5A, 2750 Ballerup, Denmark NB 0539)
2014/35/EU Niederspannungsrichtlinie: 2014/35/EU Low Voltage Directive: 2014/35/UE Directive Basse Tension: <i>Official Journal of the EU L96, 29/03/2014, p. 357–374</i>	EN 62368-1 : 2014 + AC : 2015
2014/30/EU EMV-Richtlinie 2014/30/EU EMC Directive 2014/30/UE Directive CEM <i>Official Journal of the EU L96, 29/03/2014, p. 79–106</i>	EN 61000-3-2 : 2014 EN 61000-3-3 : 2013 EN 61000-6-2 : 2005 + AC : 2005 EN 61000-6-3 : 2007 + A1 : 2011 + AC : 2012 EN 61000-6-4 : 2007 + A1 : 2011 EN 55035 : 2017 EN 55032 : 2015
2014/53/EU Funkanlagen-Richtlinie 2014/53/EU Radio Equipment Directive 2014/53/UE Directive Équipement Radioélectrique <i>Official Journal of the EU L153, 22/05/2014, p. 62–106</i>	ETSI EN 301489-1 V2.2.3 : 2019-11 ETSI EN 301489-3 V2.1.1 : 2019-01 ETSI EN 300330 V2.1.1 : 2017-02
2011/65/EU RoHS-Richtlinie 2011/65/EU RoHS Directive 2011/65/UE Directive RoHS <i>Official Journal of the EU L174, 1/07/2011, p. 88–110</i>	EN IEC 63000:2018

Für spezifische Merkmale und Bedingungen siehe Betriebsanleitung.
For specific characteristics and conditions see operating instructions.
Pour les caractéristiques et conditions spécifiques, voir le mode d'emploi.

Unterschiedet für und im Namen von: / signed for and on behalf of: / signé pour et au nom de:
R. STAHL HMI Systems GmbH

Köln, 2023-05-15

i.V.

Alexander Jung
Director R&D

i.V.

Nabil Benighil
Head of Certification

Ort und Datum
Place and date
Lieu et date

25.1.1.2 ORCA01M

EU Konformitätserklärung
EU Declaration of Conformity
Déclaration de Conformité UE



R. STAHL HMI Systems GmbH • Adolf-Grimme-Allee 8 • 50829 Köln, Germany
 erklärt in alleiniger Verantwortung, declares in ist sole responsibility, déclare sous sa seule responsabilité,

dass das Produkt: **Bedien- und Beobachtungsgeräte**
that the product: *Operating and Monitoring Devices*
que le produit: *Moniteur de commande et de visualisation*

Typ(en), type(s), type(s): ORCA01MTC3..., ORCA01MTC3 ...
 ORCA01MTC4..., ORCA01MTC4 ...
 ORCA01MTC6..., ORCA01MTC6 ...

mit den Anforderungen der folgenden Richtlinien und Normen übereinstimmt.
 is in conformity with the requirements of the following directives and standards.
 est conforme aux exigences des directives et des normes suivantes.

Richtlinie(n) / Directive(s) / Directive(s)	Norm(en) / Standard(s) / Norme(s)
2014/34/EU ATEX-Richtlinie 2014/34/EU ATEX Directive 2014/34/UE Directive ATEX Official Journal of the EU L96, 29/03/2014, p. 309–356	EN IEC 60079-0:2018 EN 60079-5:2015 EN IEC 60079-7: 2015 + A1:2018 EN 60079-11:2012 EN 60079-31:2014
Kennzeichnung, <i>marking, marquage:</i>	II 3(1) G Ex ec ib qb [ib] [ia Ga] IIC T4 Gc II 3(1) D Ex tc [ib] [ia Da] IIC T115°C Dc
EU Baumusterprüfbescheinigung: <i>EU Type Examination Certificate:</i> <i>Attestation d'examen UE de type:</i>	UL 23 ATEX 2902X (UL International Demko A/S Borupvang 5A, 2750 Ballerup, Denmark NB 0539)
2014/35/EU Niederspannungsrichtlinie: 2014/35/EU Low Voltage Directive: 2014/35/UE Directive Basse Tension: Official Journal of the EU L96, 29/03/2014, p. 357–374	EN 62368-1 : 2014 + AC : 2015
2014/30/EU EMV-Richtlinie 2014/30/EU EMC Directive 2014/30/UE Directive CEM Official Journal of the EU L96, 29/03/2014, p. 79–106	EN 61000-3-2 : 2014 EN 61000-3-3 : 2013 EN 61000-6-2 : 2005 + AC : 2005 EN 61000-6-3 : 2007 + A1 : 2011 + AC : 2012 EN 61000-6-4 : 2007 + A1 : 2011 EN 55035 : 2017 EN 55032 : 2015
2014/53/EU Funkanlagen-Richtlinie 2014/53/EU Radio Equipment Directive 2014/53/UE Directive Équipement Radioélectrique Official Journal of the EU L153, 22/05/2014, p. 62–106	ETSI EN 301489-1 V2.2.3 : 2019-11 ETSI EN 301489-3 V2.1.1 : 2019-01 ETSI EN 300330 V2.1.1 : 2017-02
2011/65/EU RoHS-Richtlinie 2011/65/EU RoHS Directive 2011/65/UE Directive RoHS Official Journal of the EU L174, 1/07/2011, p. 88–110	EN IEC 63000:2018

Für spezifische Merkmale und Bedingungen siehe Betriebsanleitung.
 For specific characteristics and conditions see operating instructions.
 Pour les caractéristiques et conditions spécifiques, voir le mode d'emploi.

Unterszeichnet für und im Namen von: / signed for and on behalf of: / signé pour et au nom de:
R. STAHL HMI Systems GmbH

Köln, 2023-05-15

i.V.

Alexander Jung
 Director R&D

i.V.

Nabil Benighil
 Head of Certification

Ort und Datum
Place and date
Lieu et date

25.2 Declaration of conformity for Equipment Compilation

R. STAHL HMI Systems GMBH

Adolf-Grimme-Allee 8 • 50829 Köln / Cologne • Germany



Betriebsanleitung für Gerätezusammenstellung / Instruction Manual for Equipment Compilation:

Diese Betriebsanleitung verweist auf die jeweilige Betriebsanleitung der verbauten Geräte. In den Betriebsanleitungen der verbauten Geräte sind alle sicherheitsrelevanten und für Installation und Betrieb erforderlichen Angaben enthalten.

Für den ordnungsgemäßen Betrieb aller zusammengehörigen Komponenten sind, außer dieser Betriebsanleitung, alle weiteren der Lieferung beigelegten Betriebsanleitungen sowie die Betriebsanleitungen der anzuschließenden Zusatzgeräte zu beachten!

Beachten Sie weiterhin, dass alle Zertifikate der Bediengeräte in einem separaten Dokument zu finden sind, welches im Internet (www.r-stahl.com) zur Verfügung steht.

This Instruction Manual refers to the documents of the devices used. All instructions concerning the installation and safe use of these devices are documented in the attached detailed instruction manuals.

It is important for safe use to follow these instructions as well all instructions of other associated devices!

Please note that all certificates of the operating and monitoring devices are available at (www.r-stahl.com).

Konformitätserklärung für Gerätezusammenstellung / Declaration of Conformity for Equipment Compilation:

Die R. STAHL HMI Systems GmbH erklärt in alleiniger Verantwortung, dass durch die Zusammenschaltung der Geräte, welche im zugehörigen Lieferschein aufgeführt sind, die Gesamtkonformität gemäß Richtlinie 2014/34/EU und 2014/30/EU und ggf. 2014/34/EU und 2014/53/EU gegeben ist.

Des Weiteren verweisen wir auf die jeweilige Konformitätserklärung der bei diesem Zusammenbau verwendeten Geräte. Diese liegen bei bzw. sind in der beiliegenden Betriebsanleitung abgedruckt.

R. STAHL HMI Systems GmbH declares in its sole responsibility that the interconnection of the devices listed in the accompanying delivery note is in conformity with directives 2014/34/EU, 2014/30/EU and, where applicable, 2014/34/EU and 2014/53/EU.

Furthermore, we refer to the individual Declarations of Conformity of the devices used, which are attached or are part of the attached operating instructions.

Köln/Cologne, September 2022



S. Zehrer
Production Director



A. Jung
Director R&D

R. STAHL HMI Systems GmbH
Adolf-Grimme-Allee 8
50829 Köln (Cologne)
Germany

T +49 221 76 806-1200
F +49 221 76 806-4200
sales.dehm@r-stahl.com
exicom.de

Headquarters: Köln
Local Court – Court of Registration:
Köln HRB 73049
VAT REG No. DE279883744

Management:
Carsten Brenner
Philipp Ohler

26 Appendix J

26.1 Release notes

The chapter entitled "Release Notes" contains all the changes made in this version of the Operating Instructions.

Version 01.00.04

- Deletion of all old release notes
- Addition of "Declarations of conformity"
- Addition of "Control Drawing"
- Adaption for "values from display" in "Technical data"
- Adaption of "Summary of applied standards"
- Addition of "Electrical data - device protection" in "Technical data"
- Changing chapter Cable glands in "Appendix A"
- Changing chapter Cable glands in "Mounting and installation" – "Installation"
- Addition of "Declaration of conformity for Equipment Compilation"
- Changing all images with cable glands into images with screw plugs
- Changing of Ex marking ATEX / IECEx, according to certificate
- Changing of Field system label / type plate
- Changing of "Type plate section" with adaption of the "Designation"
- Addition of text (list point) "exchange of cable glands" in "Mounting and installation"
- Addition of text (list point) "exchange of cable glands" in "Panel-mount – installation"
- Addition of text in "Mounting / dismantling the modules"
- Deletion of "exchange of M25 screw plug against M25 cable gland" in section "Connecting device to power supply"
- Addition of position for FO connectors in drawing "E-Box PRO"
- Deletion of "Touch pen" in all relevant sections
- Formal changes

Version 01.00.05

- Correction of standard for "Emitted interference industrial areas"
- Correction of "Type code field system", value for "Keyboard in keyboard enclosure with keyboard layout Hungarian - HU"
- Adaption of "Type code field system" to current definition
- Changing pictures in section "Dismounting modules"
- Addition of text in section "Dismounting modules"
- Addition of section "Scope of delivery"
- Correction of number of screws for x4A mounting frame
- Correction upper value of torques
- Deletion of "Installation Manual" in "Further Documents"
- Deletion of document notes "Installation manual" in all sections
- Correction r-stahl link
- Correction / Changing according to document "Comments"
- Addition of section "Appendix F – Material resistance"
- Formal changes

R. STAHL HMI Systems GmbH
Adolf-Grimme-Allee 8
D 50829 Cologne

T:	(Sales Support)	+49 221 768 06 - 1200
	(Technical Support)	+49 221 768 06 - 5000
F:		+49 221 768 06 - 4200
E:	(Sales Support)	sales.dehm@r-stahl.com
	(Technical Support)	support.dehm@r-stahl.com

r-stahl.com



THE STRONGEST LINK.