



Operating Instructions



Barcode scanner

Handheld scanner IDM164 / IDM264

Bluetooth scanner IDM164-BT / IDM264-BT



THE STRONGEST LINK.

Operating Instructions Version:
Issue:

01.04.00
30.06.2023

Table of contents

	Description	Page
	Table of contents	2
1	General information	5
1.1	Manufacturer	5
1.2	Legal notice	5
1.2.1	Trademark	5
1.2.2	Disclaimer	5
1.3	About these operating instructions	6
1.3.1	Target group	6
1.3.2	How to use this manual	6
1.3.3	Application	6
1.4	Further documents	7
1.5	Conformity with standards and regulations	8
1.5.1	Certificates	8
1.5.2	Approvals	8
	Europe (CE / ATEX)	8
	Global (IECEX)	8
1.5.3	Summary of applied standards	8
1.5.3.1	Handheld barcode scanner	8
1.5.3.2	Bluetooth barcode scanner and charging station	9
2	Explanation of symbols	10
2.1	Symbols used in these Operating Instructions	10
2.2	Warning notes	10
2.3	Symbols on the device	10
3	Safety	11
3.1	Intended use	11
3.2	Predictable improper use	11
3.3	Personnel qualification	12
3.4	Residual risks	12
3.4.1	Explosion hazard	12
3.4.2	Mechanical damage	12
3.4.3	Excessive heating or electrostatic charge	13
3.4.4	Improper mounting, installation, commissioning, maintenance or cleaning	13
3.4.5	Electric shock	14
3.4.6	Laser radiation hazard	14
3.4.7	Device damage	15
4	Function and device design	16
4.1	Features and versions	16
4.1.1	Standard components	16
4.1.2	Overview scanner versions	16
4.1.3	Overview charging stations	17
4.1.4	Overview supply modules	17
4.1.5	Connection overview handheld barcode scanner	18
4.1.5.1	Version IDM164-Z1 connection RS-xxx	18

4.1.5.2	Version IDM164-Z1 connection USB	18
4.1.5.3	Version IDM264-Z1 connection RS-xxx	18
4.1.5.4	Version IDM264-Z1 connection USB	19
4.1.6	Connection overview Bluetooth barcode scanner	19
4.1.7	Compatibility matrix Bluetooth scanner, charging stations	20
4.1.7.1	Use of Pair Code	20
4.1.7.2	Use of IDM setup tool	21
4.2	Device design	22
4.2.1	Handheld barcode scanner	22
4.2.2	Bluetooth barcode scanner	23
4.2.3	Charging station	24
4.2.4	Colour coding of connection cable for handheld barcode scanner	24
4.2.5	Mechanical dimensions	24
4.3	LEDs and acoustic signals	25
4.3.1	Handheld barcode scanner	25
4.3.2	Bluetooth barcode scanner	25
4.3.3	Charging station	26
4.4	Markings on the device	26
4.4.1	Position	26
4.4.2	Design of a type label	26
4.4.3	Ex classification ATEX / IECEx	27
4.4.3.1	Handheld barcode scanner	27
4.4.3.2	Bluetooth barcode scanner	27
4.4.3.3	Charging station	27
5	Transport and storage	28
6	Unpacking	28
7	Mounting and installation	29
7.1	Note on mounting and installation	29
7.2	Requirements for site of installation	29
7.3	Handheld barcode scanner	30
7.3.1	Connection to field enclosure.	30
7.4	Bluetooth barcode scanner	31
7.4.1	Connection of charging station to the supply module (field enclosure)	31
7.4.2	Mounting charging station at field enclosure	32
7.4.3	Connection of non-Ex charging station	33
8	Commissioning	34
8.1	Handheld barcode scanner	34
8.2	Bluetooth barcode scanner	34
8.2.1	PAIR mode	35
8.2.1.1	Quick PAIR code	35
9	Operation	36
9.1	Switching on device	36
9.2	Switching off the device	36
9.3	Scanning barcode	36
9.4	Charging Bluetooth barcode scanner	37

10	Maintenance, servicing and repair	38
10.1	Servicing	38
10.1.1	Replacing battery of Bluetooth barcode scanner	38
10.1.2	Charging Bluetooth barcode scanner	39
10.2	Maintenance	40
10.3	Repair	40
11	Returning the device	41
12	Cleaning	41
13	Accessories	42
14	Appendix A	44
14.1	Technical data	44
14.1.1	Handheld barcode scanner	44
14.1.1.1	Electrical data	45
14.1.2	Bluetooth barcode scanner	45
14.1.2.1	Electrical data	46
14.1.2.2	Charging station	47
15	Appendix B	48
15.1	Safety data	48
15.1.1	Handheld barcode scanner	48
15.1.1.1	IDM164-Z1	48
15.1.1.2	IDM264-Z1	49
15.1.2	Charging station IDMy64-BT-Base-Z1	49
16	Appendix C	50
16.1	Proof of intrinsic safety	50
16.1.1	General information	50
16.1.2	Connections	51
16.1.2.1	Handheld barcode scanner	51
16.1.2.2	Bluetooth barcode scanner	53
17	Appendix D	55
17.1	Disposal / Restricted substances	55
17.1.1	Declaration of substances and restricted substances	55
17.1.1.1	Declarable substance groups	55
17.1.1.2	RoHS directive 2011/65/EC	55
18	Appendix H	56
18.1	Declarations of conformity	56
18.1.1	EU	56
18.1.1.1	Handheld barcode scanner IDMy64-Z1	56
18.1.1.2	Bluetooth barcode scanner IDMy64-BT-Z1	57
18.1.1.3	Charging station IDMy61-BT-Base-A (Non-Ex)	58
18.1.1.4	Charging station IDMy64-BT-Base (Non-Ex)	59
19	Appendix I	60
19.1	Release notes	60

1 General information

1.1 Manufacturer

R. STAHL HMI Systems GmbH
Adolf-Grimme-Allee 8
50829 Köln
Germany

Sales Support

Tel.: +49 221 768 06 – 1200
E-mail: sales.dehm@r-stahl.com

Technical Support

Tel.: +49 221 768 06 – 5000
E-mail: support.dehm@r-stahl.com

General

Fax: +49 221 768 06 – 4200
Internet: r-stahl.com

1.2 Legal notice

1.2.1 Trademark

The terms and names used in this document are registered trademarks and/or products of the companies in question.

1.2.2 Disclaimer

- All rights reserved.
- This document may not be reproduced in whole or in part except with the written consent of the publisher.
- This document may be subject to change without notice.

Any warranty claims are limited to the right to demand amendments. Liability for any damage that might result from the contents of these instructions or all other documentation is limited to clear cases of premeditation.

We reserve the right to amend our products and their specifications at any time, provided it is in the interest of technical progress. The information in the current manual (online or on CD / DVD / USB-stick) or in the operating instructions included in the delivery applies.

1.3 About these operating instructions

This document contains safety-relevant information. It may be changed anywhere provided the contents and meaning of the safety-relevant information remain unaltered.

All data relevant to explosion protection has been copied to these Instructions from the EC type examination certificate.

1.3.1 Target group

These operating instructions are intended for the following groups of people:

- Project engineers
- Electricians and installers
- Operators
- Operating staff
- Maintenance staff

1.3.2 How to use this manual

- Read these operating instructions, especially the safety notes, carefully before use.
- Take note of all other applicable documents (see also chapter [1.4 Further documents](#)).
- Keep the operating instructions throughout the service life of the device.
- Make the operating instructions accessible to operating and maintenance staff at all times.
- Pass the operating instructions on to each subsequent owner or user of the device.
- Update the operating instructions every time R. STAHL issues an amendment.

1.3.3 Application

Operating Instructions
version: 01.04.00

The following operating instructions apply to the following devices:

Handheld barcode scanner	IDM164-Z1 IDM264-Z1
Bluetooth barcode scanner	IDM164-BT-Z1 IDM264-BT-Z1
Charging station	IDMx64-BT-Base-Z1

The original instructions are the German edition.
They are legally binding in all legal matters.

1.4 Further documents

Operating Instructions VM125-ex (OI_VM125-ex)

Certificate compilation scanner (CE_IDM)

Certificate compilation VM125-ex (CE-VM125-ex)

Quick start instructions IDM Bluetooth issued by Sick AG

Operating instructions handheld scanner issued by Sick AG



For documents in other languages, see [r-stahl.com](https://www.r-stahl.com).

1.5 Conformity with standards and regulations

1.5.1 Certificates

	Certificates: r-stahl.com The devices have IECEx approval. See IECEx homepage: https://www.iecex-certs.com/#/home to view the certificate.
---	---

1.5.2 Approvals

The following approvals are valid for all devices:

Synonym	Scope of validity	Device	Valid until	Certificate number
CE / ATEX	Europe	Handheld barcode scanner	unlimited	IBExU16ATEX1002
		Bluetooth barcode scanner		IBExU16ATEX1003
IECEX	Global	Handheld barcode scanner	unlimited	IECEX IBE 16.0002
		Bluetooth barcode scanner		IECEX IBE 16.0003

1.5.3 Summary of applied standards

1.5.3.1 Handheld barcode scanner

Standard	Classification
IEC 60079-0 : 2018	General requirements
IEC 60079-11 : 2012	Protection by intrinsic safety "i"
IEC 60079-28 : 2015	Optical radiation "op is"

1.5.3.1.1 EMC Directive 2014/30/EU

Standard	Classification
EN 61000-6-2 : 2019	Immunity
EN 61000-6-4 : 2020	Emitted interference

1.5.3.1.2 RoHS Directive 2011/65/EU

Standard	Classification
EN IEC 63000 : 2018	Technical documentation for the assessment of electrical and electronic equipment with regard to the restriction of hazardous substances

1.5.3.2 Bluetooth barcode scanner and charging station

Standard	Classification
IEC 60079-0 : 2018	General requirements
IEC 60079-11 : 2012	Protection by intrinsic safety "i"
IEC 60079-28 : 2015	Optical radiation "op is"

1.5.3.2.1 EMC Directive 2014/30/EU

Standard	Classification
EN 61000-6-2 : 2005 + AC : 2005	Immunity
EN 61000-6-4 : 2007 + A1 : 2011	Emitted interference

1.5.3.2.2 Radio equipment directive 2014/53/EU



Standard	Classification
EN 60950-1 : 2006 + A1 : 2010 + A2 : 2013 + A11 : 2009 + A12 : 2011	Information technology devices – Safety (General Requirements)
EN 300328 V2.1.1 : 2016	Electromagnetic compatibility and radio spectrum matters (ERM) - broadband transmission systems - data transmission systems
EN 301489-1 V2.2.0 : 2017	Electromagnetic compatibility and radio spectrum matters (ERM) Compatibility for radio equipment and radio services Joint technical requirements
EN 301489-17 V3.2.0 : 2017	Electromagnetic compatibility and radio spectrum matters (ERM) Electromagnetic compatibility - Special conditions for broadband transmission systems
EMC and low voltage directive are included	

1.5.3.2.3 RoHS Directive 2011/65/EU





Standard	Classification
EN IEC 63000 : 2018	Technical documentation for the assessment of electrical and electronic equipment with regard to the restriction of hazardous substances



2 Explanation of symbols

2.1 Symbols used in these Operating Instructions



Symbol	Meaning
	Useful hint for making work easier, important note
	Reference to another chapter, another section, another documentation or another web page.

2.2 Warning notes

	Hazardous situation which can result in fatal or severe, life-changing injuries if the safety measures are not complied with.
	Hazardous situation which can result in severe injuries if the safety measures are not complied with.
	Hazardous situation which can result in minor injuries if the safety measures are not complied with.
	Hazardous situation which can result in material damage if the safety measures are not complied with.

Symbol	Meaning
	Heat hazard
	Laser radiation hazard

2.3 Symbols on the device

Symbol	Meaning
	Device certified for hazardous areas according to ATEX directive.
	Device marking according to EU directive
0158	ID number of monitoring body

3 Safety

The device has been manufactured according to the state of the art of technology while observing recognised safety-related rules. When using the device, it is nevertheless possible for hazards to occur to life and limb of the user or third parties or for the device, environment or material assets to be compromised.

Only use the device under the following conditions:

- If it is not damaged
- As intended, while remaining aware of safety and hazards
- In accordance with these operating instructions.

3.1 Intended use



Without exception, the barcode scanners and charging stations as well as the VM125-ex-* devices **must not** be operated in nuclear facilities !

The type IDM barcode scanners are used to capture data and transmit them to PCs and similar devices in hazardous areas.

The barcode scanners are explosion-protected equipment for installation in hazardous areas Zone 1, 21, 2, 22.

The VM125-ex-* supply module is used for the power supply and data communication of the barcode handscanner and the charging station. The Bluetooth barcode scanners are supplied with power via a battery. Data communication is via Bluetooth. The supply module is connected to the handheld barcode scanner or the charging station of the Bluetooth scanner via the VB-IDM cable. An RS-232, RS-422 or a USB connection can be used for the data connection to PCs or similar devices (see chapter [4.1.4 Overview supply modules](#)).

The permitted temperature range is from -20 °C to +50 °C.

"Intended use" includes complying with these operating instructions and the other applicable documents, e.g. the data sheet. All other uses are only considered to be intended after being approved by R. STAHL.

3.2 Predictable improper use

The device may only be installed and connected by specifically trained personnel. The IDMX61-BT-Base-A and IDMX61-Base-A charging stations must not be operated in hazardous areas. In Explosion Group IIC, the VM125-ex-RS232-*-*600mA supply module must not be used with the IDM264-Z1 handheld barcode scanner.

3.3 Personnel qualification

Qualified specialist personnel is required to perform the activities described in these operating instructions. This primarily applies to tasks in the following areas:

- Product selection and project engineering
- Mounting/dismounting the device
- Installation
- Commissioning
- Maintenance, cleaning

Specialists who perform these tasks must have a level of expertise that meets applicable national or equivalent country-specific standards and regulations. Additional expertise is required for any activity in hazardous areas!

R. STAHL recommends having a level of expertise equal to that described in the following standards:

- IEC/EN 60079-14 (Electrical installations design, selection and erection)
- IEC/EN 60079-17 (Inspection and maintenance of electrical installations)
- IEC/EN 60079-19 (Equipment repair, overhaul and reclamation)

3.4 Residual risks

3.4.1 Explosion hazard

Despite the device's state-of-the-art design, explosion hazards cannot be entirely eliminated in hazardous areas.

- Perform all tasks in hazardous areas with the utmost care at all times!

Possible hazards ("residual risks") can be categorised according to the following causes:

3.4.2 Mechanical damage

The device may become damaged during transport, mounting or commissioning. This kind of damage may, for example, render the device's explosion protection partially or completely ineffective. This may result in explosions causing serious or even fatal injury.

- Do not commission a damaged device.
- Only transport the device in special transport packaging that reliably protects the device from external influences. Take ambient conditions into account when selecting the transport packaging (see chapter [14.1 Technical data](#)).
- Do not place any loads on the device.
- Check the packaging and the device for damage. Immediately report any damage to R. STAHL.
- Store the device ideally in its original packaging in a dry place (with no condensation), and make sure that it is stable and protected against the effects of vibrations and knocks.
- Do not damage the device or seals during its installation.

- The device must be switched off immediately if it is likely that as a consequence of damaging impact or general peculiarities the device can no longer be safely operated (e.g. ingress of water, fluids, impact of temperatures beyond the specified range).

3.4.3 Excessive heating or electrostatic charge

- Operate the device only within the prescribed operating conditions (see chapter [4.4 Markings on the device](#) and chapter [14.1 Technical data](#)).
- Mount and install the device in such a way that it is always operated within the permissible temperature range.
- Do not use the device in strong charge-generating environments.
- Avoid friction and flow of particle streams.
- Regularly inspect the device for a material change. If you spot any changes, test or replace the device.
- Comply with the area specification of EN/IEC 60079-0 when fitting additional plastic adhesive labels.
- Clean the device with a damp cloth only.
- Do not cover the display with protective foil.

3.4.4 Improper mounting, installation, commissioning, maintenance or cleaning

Basic work such as installation, commissioning, maintenance or cleaning of the device must always be performed in accordance with the applicable national regulations of the country of use and only by qualified persons. Otherwise, the explosion protection may be rendered ineffective. This may result in explosions causing serious or even fatal injury.

- Have the assembly, installation, commissioning and maintenance work performed by qualified and authorised persons only (see chapter [3.3 Personnel qualification](#)).
- Electrical plants are subject to certain regulations concerning installation and operation (e.g. Directive 99/92/EC, Directive 2014/34/EC, or the national rules such as IEC/EN 60079-14 and series DIN VDE 0100).
- Observe national safety and accident prevention regulations.
- Observe general code of practice.

Installation

- Make sure that the barcode scanners and the IDMx64-BT-Base-Z1 charging stations are only installed and operated in Zones 1, 21, 2 and 22.
- The intrinsically safe circuits must be designed according to applicable regulations.
- Connect the device and its accessories to intrinsically safe circuits only.
- Make sure that the safety-relevant values of the device, accessories and connected device are in accordance with each other.
- The devices may only be installed and operated in an undamaged, dry and clean condition!

Commissioning

- Prior to commissioning, check the device is correctly mounted (see chapter [7 Mounting and installation](#)).
- The devices may only be operated when fully assembled.

Operation

- Do not insert any sharp objects into the enclosure or into any other openings of the device. Do not block, obstruct or cover any openings at the device.
- Ensure firm footing and sufficient room for movement.

Servicing

- Repair and maintenance work at the device in hazardous areas must be carried out in compliance with generally recognised technical rules, standards and legislation.

Repair

- Do not change or modify the device.
- Any repairs must only be carried out by R. STAHL.

Cleaning

- Gently clean the device with a damp cloth only – do not use scratching, abrasive or aggressive cleaning agents or solutions.
- Never clean the device with a strong water jet, such as a pressure washer.
- In hazardous areas the device may not be wiped or cleaned with a dry cloth!

3.4.5 Electric shock

During operation and maintenance, high voltage is at times applied to the device. Because of this, the device must be de-energised during installation. Persons coming into contact with electrical lines carrying excessively high voltage can suffer severe electric shocks and, consequently, injuries.

- Only connect electrical circuits to suitable terminals.

3.4.6 Laser radiation hazard

Devices equipped with laser are covered by standards US 21 CFR 1040.10 and EN 60825-1.

Class 1 lasers are deemed inherently safe during normal use. Class 2 lasers use a visible low-voltage LED. Brief exposure to a class 2 laser is deemed not dangerous.

Non-intended use may result in dangerous levels of exposure to radiation, resulting in damage to the retina.

- Do not look directly into the laser beam.

3.4.7 Device damage

As a result of unsuitable operating conditions or careless contact the device or individual components may be damaged so significantly that the device does not operate correctly or fails completely.

- Do not subject the device to external heat sources or direct sunshine. Ensure that the maximum ambient temperature is never exceeded.
- Do not open the enclosure.

4 Function and device design

4.1 Features and versions

The type IDM barcode scanners are used to capture data and transmit them to PCs and similar devices in hazardous areas.

The barcode scanners are explosion-protected equipment for installation in hazardous areas Zone 1, 21, 2, 22.

The VM125-ex-* supply module is used for the power supply and data communication of the handheld barcode scanner and the charging station. The Bluetooth barcode scanners are supplied with power via a battery. Data communication is via Bluetooth. The supply module is connected to the handheld barcode scanner or the charging station of the Bluetooth scanner via the VB-IDM cable. An RS-232, RS-422 or a USB connection can be used for the data connection to PCs or similar devices (see chapter [4.1.4 Overview supply modules](#)).

The barcode scanners differ in design (the wired handheld barcode scanner and the Bluetooth barcode scanner) and function (scannable barcode types) (see chapter [4.1.2 Overview scanner versions](#)).

4.1.1 Standard components

The following components are the standard barcode scanner components:	
Handheld barcode scanner	Bluetooth barcode scanner
IDM164-Z1	IDM164-BT-Z1
–	Charging station IDMx64-BT-Base-Z1
VM125-ex-RS232-*	VM125-ex-RS232-*
IDMx6x-Socket-3+PE	–
VB-IDMx60-RS232-1.8m	VB-IDMx6x-Base-VM-RS232-1.8m-Z1

4.1.2 Overview scanner versions

Scanner type	fixed cable	Bluetooth	1D	PDF	2D
IDM164-Z1	✓	✗	✓	✓	✗
IDM264-Z1	✓	✗	✓	✓	✓
IDM164-BT-Z1	✗	✓	✓	✓	✗
IDM264-BT-Z1	✗	✓	✓	✓	✓

4.1.3 Overview charging stations

Charging station	without cable	Bluetooth	Ex Zone 1, 21	Non-Ex	IDM164	IDM264
IDMx64-BT-Base-Z1	✓	✓	✓	✗	✓	✓
IDMx61-BT-Base-A	✓	✓	✗	✓	✓	✓
IDMx64-BT-Base	✓	✓	✗	✓	✓	✓
IDMx61-Base-A	✓	✗	✗	✓	✓	✓

4.1.4 Overview supply modules

 Separate operating instructions are available for the VM125-ex-* supply modules.

 DANGER	<p>Explosion hazard when exceeding electric parameters ! Non-compliance may result in fatal or serious injuries.</p> <ul style="list-style-type: none"> In explosion group IIC, the IDM264-Z1 handheld barcode scanner must not be used together with the VM125-ex-* -600mA supply module.
---	---

Supply modules	Compatible handheld scanners	Interface			Power supply	
		RS-232	RS-422	USB	AC	DC
VM125-ex-RS232-AC-230V	IDM164-Z1	✓	✓	✗	✓	✗
VM125-ex-RS232-DC-24V	IDM164-Z1	✓	✓	✗	✗	✓
VM125-ex-USB-AC-230V	IDM164-Z1	✗	✗	✓	✓	
VM125-ex-USB-DC-24-V	IDM164-Z1	✗	✗	✓	✗	✓
VM125-ex-RS232-AC-230V-600mA	IDM264-Z1	✓	✓	✗	✓	✗
VM125-ex-RS232-DC-24V-600mA	IDM264-Z1	✓	✓	✗	✗	✓
VM125-ex-USB-AC-230V-600mA	IDM264-Z1	✗	✗	✓	✓	✗
VM125-ex-USB-DC-24V-600mA	IDM264-Z1	✗	✗	✓	✗	✓

4.1.5 Connection overview handheld barcode scanner

4.1.5.1 Version IDM164-Z1 connection RS-xxx

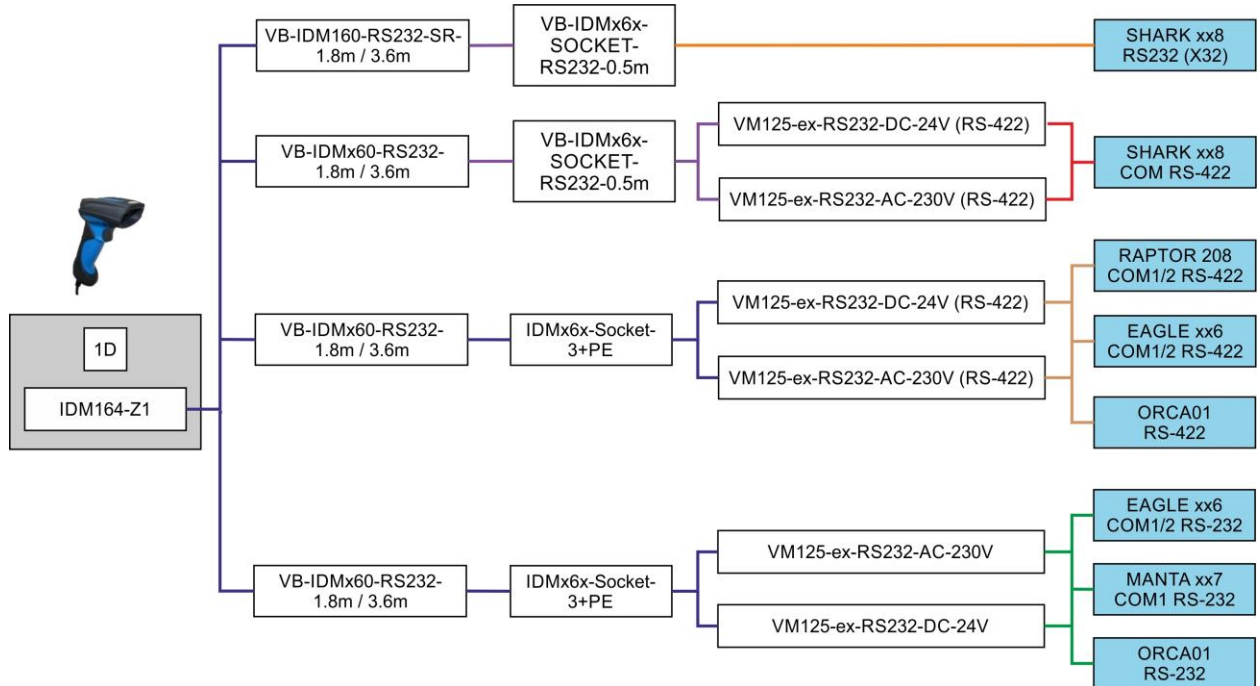

4.1.5.2 Version IDM164-Z1 connection USB

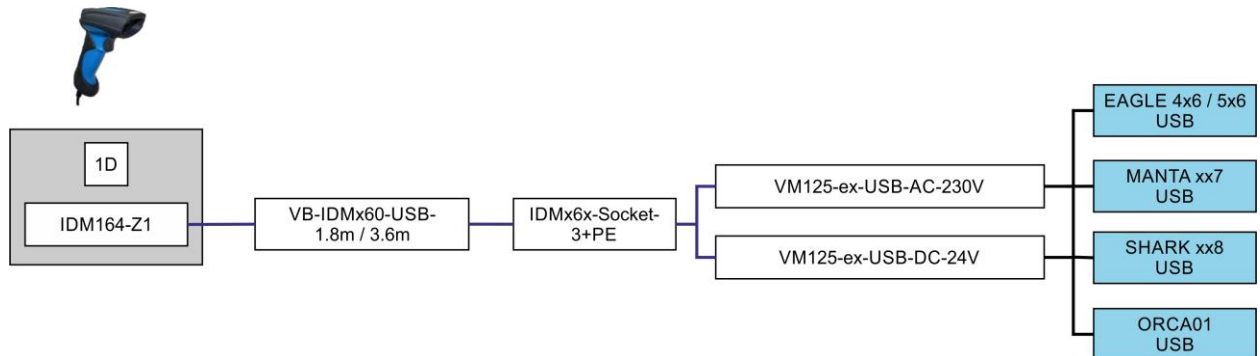

4.1.5.3 Version IDM264-Z1 connection RS-xxx

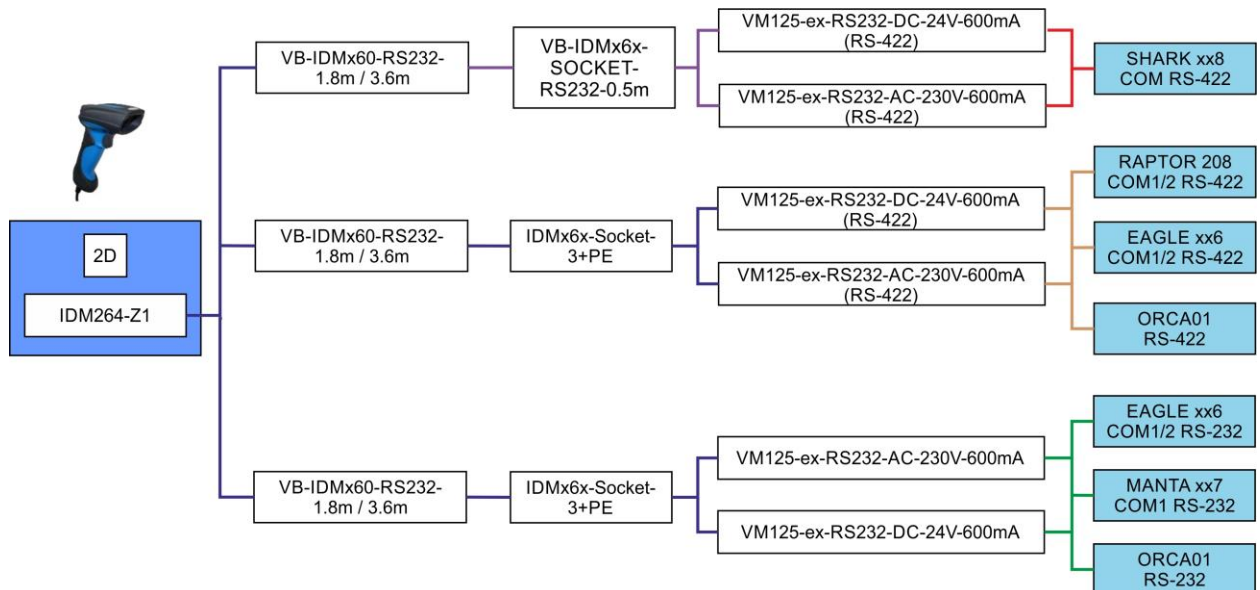

4.1.5.4 Version IDM264-Z1 connection USB

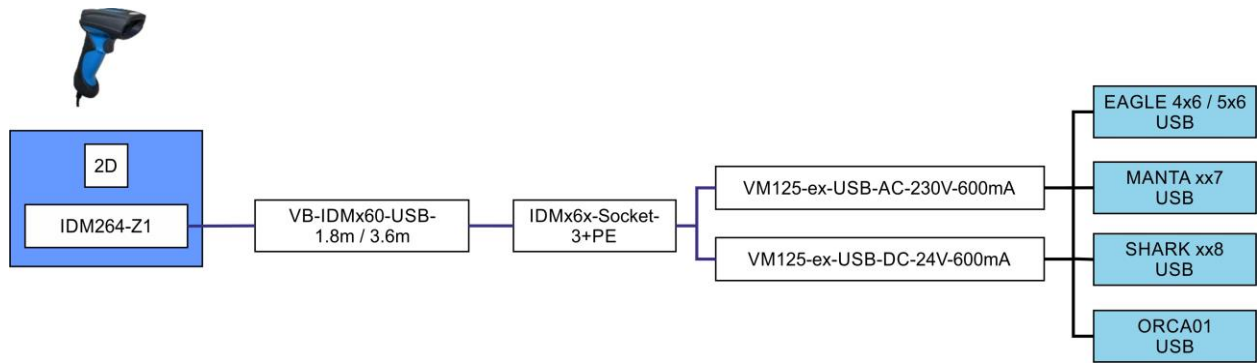

4.1.6 Connection overview Bluetooth barcode scanner

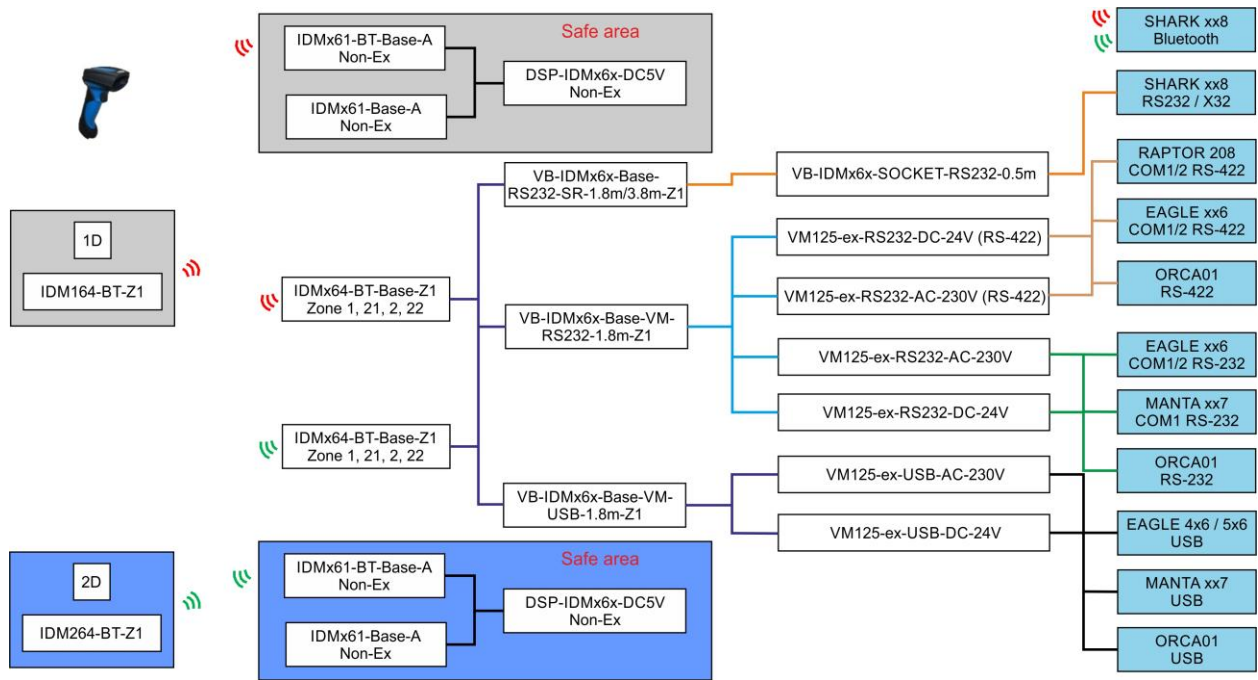

4.1.7 Compatibility matrix Bluetooth scanner, charging stations

Scanner type / Charging station	IDM160-BT-ex	IDM161-BT-ex	IDM164-BT-Z1	IDM261-BT-ex	IDM261-BT-A-ex	IDM264-BT-Z1
IDM160-BT-Base-Z1	P	P	N	N	N	N
IDMx61-BT-Base-Z1	N	P	N	P	P	N
IDMx61-BT-Base-A-Z1	N	P	P	P	P / Q	Q
IDMx64-BT-Base-Z1	N	F	Q	N	Q	Q
IDMx64-BT-Base Non-Ex	C	C	C	C	C	C

Legend		
P	compatible	Connection between scanner and charging station established via the Pair mode (see quick guide)
Q	compatible	Connection between scanner and charging station established via the Quick Pair code of the charging station
N	not compatible	-
C	charging function only	-
F	note firmware status	Quick Pair code can only be used with FW 4.10.19 or higher.

4.1.7.1 Use of Pair Code

Possible combinations		Pairing Mode	
Scanner	Charging station	Pair Mode from Quick Guide	Quick Pair Code of charging station
IDM164-BT-Z1	IDMx61-BT-Base-A-Z1	✓	✓
IDM264-BT-Z1	IDMx61-BT-Base-A-Z1	✓	✓
IDM164-BT-Z1	IDMx64-BT-Base-Z1	✗	✓
IDM264-BT-Z1	IDMx64-BT-Base-Z1	✗	✓
IDM161-BT-ex	IDMx64-BT-Base-Z1	✗	✓ *
IDM261-BT-A-ex	IDMx64-BT-Base-Z1	✗	✓

* Firmware 4.10.19 or higher

4.1.7.2 Use of IDM setup tool

Device combinations		Setup Tool 4.0				
		FW update from				
Scanner	Charging station	Scanner	Charging station	Parameterisation	iCode function	GS1 configuration
IDM164-BT-Z1	IDMx61-BT-Base-A-Z1	✓	✗	✓	✓	✓
IDM264-BT-Z1	IDMx61-BT-Base-A-Z1	✓	✗	✓	✓	✓
IDM164-BT-Z1	IDMx64-BT-Base-Z1	✓	✓	✓	✓	✓
IDM264-BT-Z1	IDMx64-BT-Base-Z1	✓	✓	✓	✓	✓
IDM161-BT-ex	IDMx64-BT-Base-Z1	✗	✓	✗	✗	✗
IDM261-BT-A-ex	IDMx64-BT-Base-Z1	✗	✓	✗	✗	✗



The IDM161-BT-ex and IDM261-BT-A-ex barcode scanners can only be parameterised with the 2.05.26 setup tool.

4.2 Device design

4.2.1 Handheld barcode scanner



Item	Designation
1	Grip
2	Scanning window
3	Scanning button
4	Operating indicator
5	Status indicator
6	Cable connection to supply module
7	Sealing strip
8	Mounting hook (not visible in picture)
9	RJ plug with clip

4.2.2 Bluetooth barcode scanner



Item	Designation
1	Grip
2	Scanning window
3	Scanning button
4	Connection indicator
5	Status indicator
6	Battery compartment
7	Sealing strip
8	Mounting hook (not visible in picture)
9	Battery compartment lid
10	Safety screw
11	Loading contacts

LEDs of IDM264 Bluetooth barcode scanner

 The LEDs of the IDM264 Bluetooth barcode scanner are located at the top back.



Item	Designation
1	Connection indicator
2	Status indicator

4.2.3 Charging station

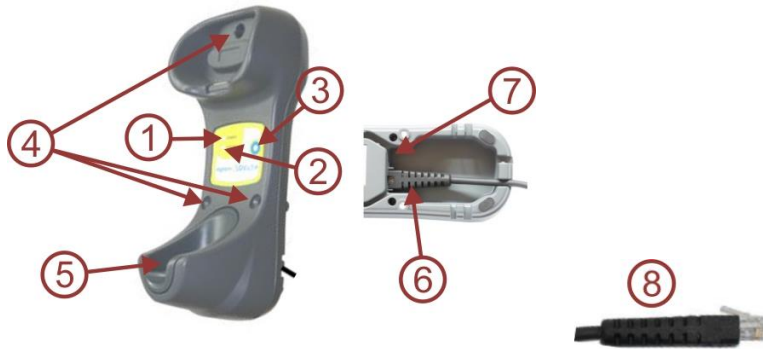

Item	Designation
1	Operating indicator
2	Status indicator
3	Paging / reset button
4	Drilling / fixing holes
5	Loading contacts
6	Cable connection to supply module
7	Power connection (non-Ex loading station)
8	RJ plug for item 6

! In charging stations for hazardous areas the power connection is closed ex-factory.

4.2.4 Colour coding of connection cable for handheld barcode scanner

! To distinguish between interface versions (USB or RS232), the connection cables of the handheld barcode scanners are marked with coloured heat-shrink tubes.

Interface version	Colour coding	Image
RS232	blue / yellow	
USB	blue / green	

4.2.5 Mechanical dimensions

Dimensions in mm.

Device	Width	Height	Depth / length
Barcode scanner	104	185	76
Charging station	100	225	90

4.3 LEDs and acoustic signals



This section only covers the most important LEDs and acoustic signals. LEDs and acoustic signals may vary according to how they were programmed. For information on programming please refer to SICK AG's handbook (www.SICK.com).

4.3.1 Handheld barcode scanner

Connection indicator			
Status LED	LED colour	Acoustic signal	Meaning
flashing 1x every 2.5 seconds	blue	off	Power supply connected
Status indicator			
flashing once	green	1 acoustic signal	barcode scanned successfully

4.3.2 Bluetooth barcode scanner

Connection indicator			
Status LED	LED colour	Acoustic signal	Meaning
flashing 1x every 2.5 seconds	blue	off	Bluetooth connection established
flashing 3x every 2 seconds	blue	off	Bluetooth disconnected
flashing 1x every 2.5 seconds	blue	4 ascending acoustic signals	establishing Bluetooth connection
flashing 3x every 2 seconds	blue	4 descending acoustic signals	disconnecting Bluetooth
flashing rapidly	blue	short clicks	establishing Bluetooth connection
flashing rapidly	blue	short clicks	transferring data
Status indicator			
flashing once	green	1 acoustic signal	barcode scanned successfully
lit	red	off	charging
lit	green	off	fully charged
flashing once at regular intervals	red	1 acoustic signal at regular intervals	battery charge low
off	–	off	standby mode or battery empty

4.3.3 Charging station

Indications				Acoustic signal	Meaning
Operating indicator		Status indicator			
LED Status	LED Colour	LED Status	LED Colour		
flashing once	blue	off	–	1 acoustic signal	Power supply on
off	–	flashing alternately	red / green	off	Connection between scanner and base station cut

4.4 Markings on the device

4.4.1 Position



Item	Designation
1	Type label

4.4.2 Design of a type label

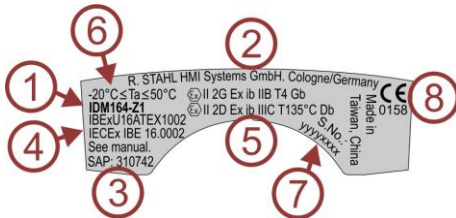



Item	Designation
1	Scanner type
2	Manufacturer
3	SAP material number
4	Certificate numbers
5	Ex classification ATEX / IECEx
6	Approved ambient temperature
7	Serial number (yyyyxxxx – y = year, x = six-digit number)
8	CE number

4.4.3 Ex classification ATEX / IECEx



Ex marking ATEX / IECEx according to IEC 60079-0 and ATEX directive 2014/34/EU.

4.4.3.1 Handheld barcode scanner

IDM164-Z1



Version	2014/34/EU prefix	Ex marking
Gas	 II 2 G	Ex ib IIB T4 Gb
Dust	 II 2 D	Ex ib IIIC T135°C Db

IDM264-Z1



Version	2014/34/EU prefix	Ex marking
Gas	 II 2 G	Ex ib op is IIB T4 Gb
Dust	 II 2 D	Ex ib op is IIIC T135°C Db

4.4.3.2 Bluetooth barcode scanner



IDM164-BT-Z1

Version	2014/34/EU prefix	Ex marking
Gas	 II 2 G	Ex ib IIB T4 Gb
Dust	 II 2 D	Ex ib IIIC T135°C Db

IDM264-BT-Z1

Version	2014/34/EU prefix	Ex marking
Gas	 II 2 G	Ex ib op is IIB T4 Gb
Dust	 II 2 D	Ex ib op is IIIC T135°C Db

4.4.3.3 Charging station

Version	2014/34/EU prefix	Ex marking
Gas	 II 2 G	Ex ib IIB T4 Gb
Dust	 II 2 D	Ex ib IIIC T135°C Db

5 Transport and storage

NOTE	<p>Ensure packaging is undamaged during transport and storage</p> <p>Non-compliance may result in material damage. If the device is transported or stored without packaging, shocks, vibrations, pressure and humidity can directly impact the device. Damaged packaging indicates that the device has been subjected to and possibly been damaged by outside influences. This may result in faulty functionality.</p> <ul style="list-style-type: none">• Transport and store the device in undamaged packaging, ideally in the original packaging.• Follow measures for proper transport and storage.
-------------	---

Transport

- Check the state of the packaging.
- Report any damage sustained in transport to the haulier responsible and have it confirmed.
- Do not drop the device.

Storage

- Ensure specified storage temperature range is not exceeded (see chapter [14.1 Technical data](#)).
- Store the device in a dry place free of vibrations.

6 Unpacking

- Unpack the device at its final destination.
- Check against the delivery note that the contents are complete and undamaged.
- Contact the manufacturer if the contents are incomplete, damaged or not what you have ordered.
- Dispose of the packaging materials according to local regulations.

7 Mounting and installation

7.1 Note on mounting and installation



Interconnecting several devices in a single intrinsically safe circuit can result in different safety characteristic values. This could compromise intrinsic safety.

Unless agreed otherwise, all components are usually mounted inside / at the field enclosure of R. STAHL HMI Systems GmbH, and are fully and functionally wired.

Observing the following points will ensure a professional and safe assembly and installation

- Mount the device carefully and strictly in accordance with the safety notes (see chapter [3 Safety](#)).
- Additional, corresponding safety regulations apply to electronic and pneumatic installations.
- In Germany, these include the BGI 547 (Information on and principles of workplace safety and health issued by the Government Safety Association) and the BetrSichVer (Betriebsicherheitsverordnung - Occupational Safety and Health).
- Study the installation conditions and assembly instructions in these operating instructions carefully and follow them to the letter.

7.2 Requirements for site of installation



Take the operating temperature of the device into account when choosing where to install the device.

7.3 Handheld barcode scanner

7.3.1 Connection to field enclosure.



The power supply module is located inside the field enclosure and is fully pre-wired.

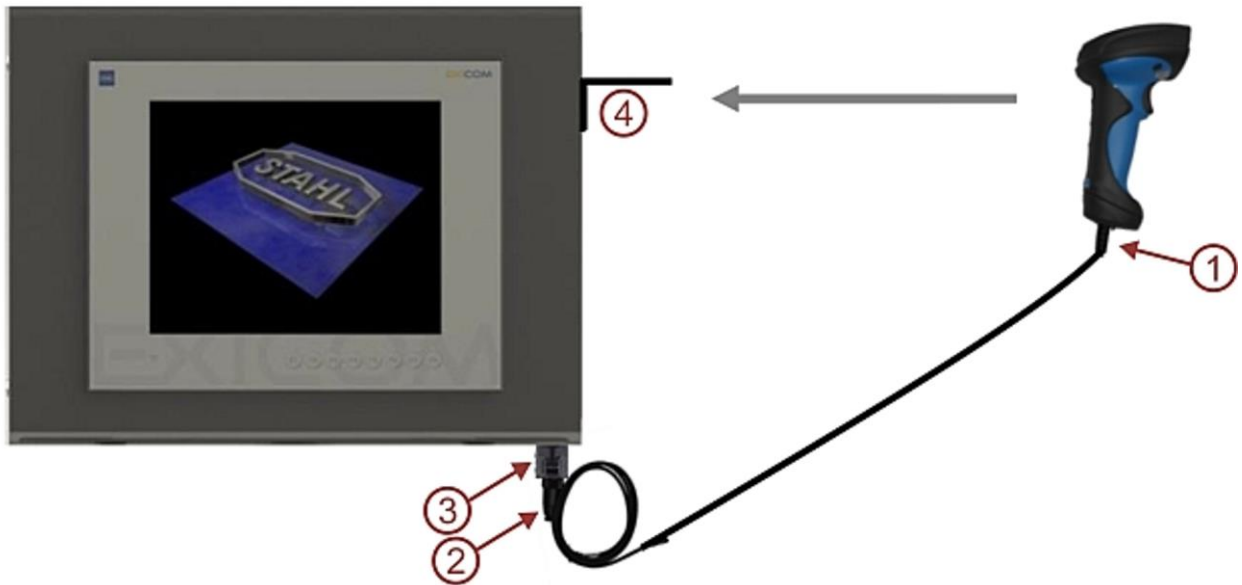

Item	Designation
1	RJ45 plug
2	Binder plug
3	Binder fixed socket
4	Scanner holder at field enclosure

- Insert RJ45 plug (1) into the associated socket at the handheld barcode scanner with an audible click.

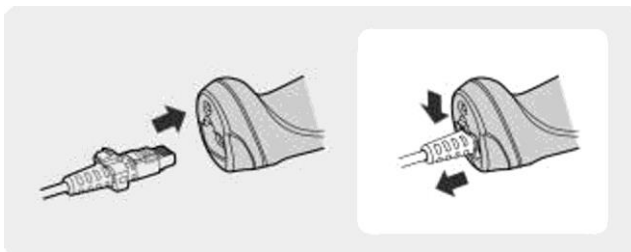

- Make sure that the cable is firmly connected.
- Insert Binder plug (2) into Binder fixed socket (3).
- Place handheld barcode scanner into the holder (4) mounted at the field enclosure.

7.4 Bluetooth barcode scanner

7.4.1 Connection of charging station to the supply module (field enclosure)



The power supply module is located inside the field enclosure and is fully pre-wired.

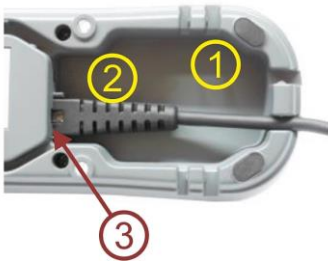

Item	Designation
1	Bottom of charging station
2	RJ45 plug
3	Socket for RJ45 plug

- Insert RJ45 plug (2) of the connecting cable into the associated socket (3) at the bottom of the charging station with an audible click.

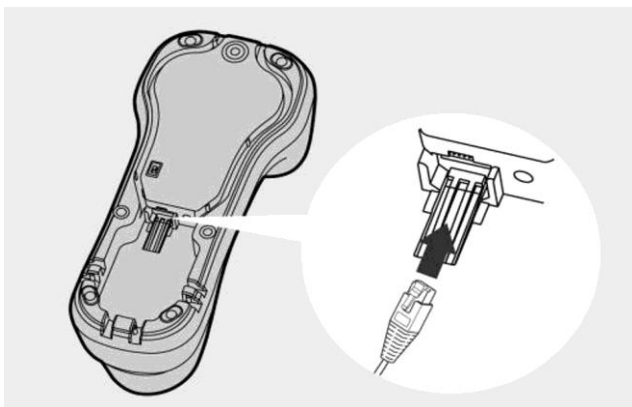

- Make sure that the cable is firmly connected.

7.4.2 Mounting charging station at field enclosure

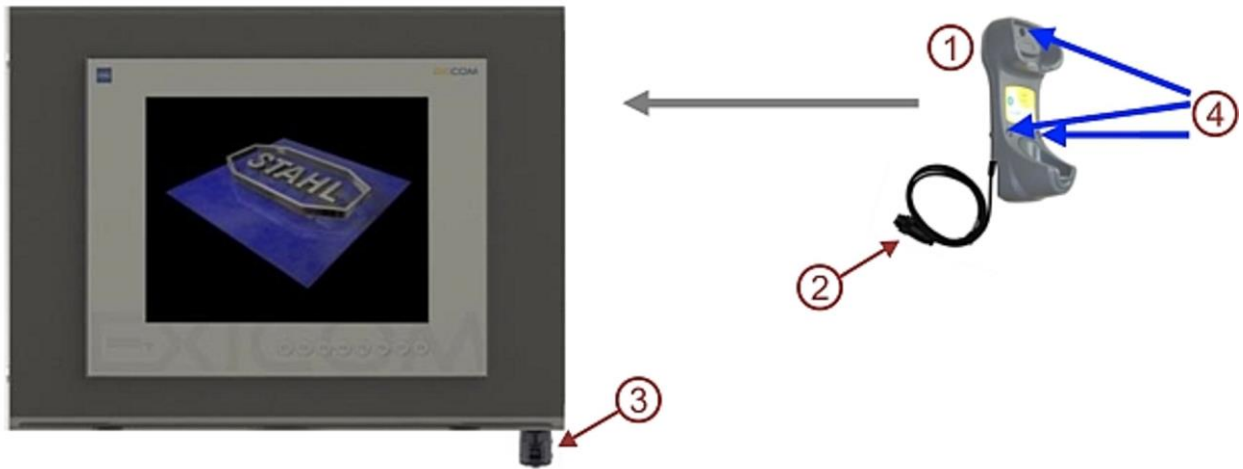

Item	Designation
1	Charging station
2	Binder plug
3	Binder fixed socket
4	Screw holes charging station

- Connect charging station to field enclosure with 3 screws (1x M4x30 mm, 2x M4x40 mm) through the screw holes (4) at the charging station.
- Insert Binder plug (2) into Binder fixed socket (3).



- Place Bluetooth barcode scanner correctly into the charging station (see chapter [9.4 Charging Bluetooth barcode scanner](#)).

7.4.3 Connection of non-Ex charging station

The non-Ex charging station requires a power supply, which is connected to the loading station.

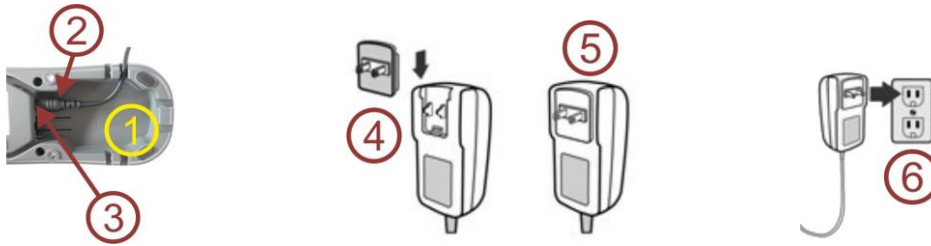

Item	Designation
1	Bottom of charging station
2	Stereo jack
3	Socket for stereo jack
4	Alternating current adapter (included in delivery)
5	Wall power supply
6	Wall-mounting socket

- Plug stereo jack (2) of power cable into associated socket (3) at the bottom of the charging station (1).
- Select suitable alternating current adapter and attach to wall power supply (4).
- Plug wall power supply (5) into wall-mounting socket (6)
- Place Bluetooth barcode scanner correctly into the charging station (see chapter [9.4 Charging Bluetooth barcode scanner](#)).

8 Commissioning

- Make sure all components are complete before commissioning device.

Particular care shall be taken that:

- the devices have been installed according to instructions,
- the devices are not damaged,
- all screws are tightened fast,
- all cables are connected properly.



For the barcode scanners to be fully commissioned, the programming information contained in the manual issued by 'SICK AG (www.SICK.com) is also required.

8.1 Handheld barcode scanner

The handheld barcode scanners are usually pre-mounted, functionally wired and tested. They can be commissioned with the standard parameters.

8.2 Bluetooth barcode scanner



DANGER

Explosion hazard when inserting batteries in hazardous areas!

Non-compliance may result in fatal or serious injuries.

- Do not replace battery in hazardous areas.
- Take Bluetooth barcode scanner into safe area.



Charge new batteries for 8 hours prior to first use.

The Bluetooth barcode scanners are usually pre-mounted, functionally wired and tested. They can be commissioned with the standard parameters.

Delivery of the Bluetooth barcode scanners includes the battery.

Before commissioning the Bluetooth scanner, charge and insert the battery.

- Inserting battery (see chapter [10.1.1 Replacing battery of Bluetooth barcode scanner](#)).
- Charging battery (see chapter [9.4 Charging Bluetooth barcode scanner](#)).

8.2.1 PAIR mode



The PAIR mode is used to connect a Bluetooth barcode scanner to a charging station. Products delivered as a set (Bluetooth barcode scanner together with charging station) are already connected in PAIR mode.



For functionality and how to proceed, see manual of SICK AG (www.SICK.com).

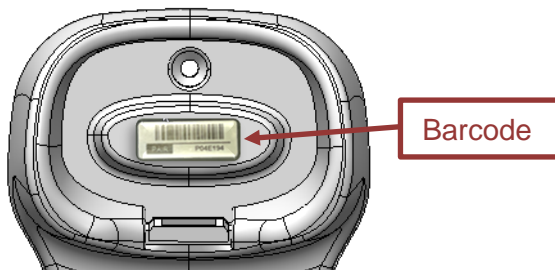

8.2.1.1 Quick PAIR code

- Fast connection of Bluetooth barcode scanner with charging station
- The charging station has a barcode.
- By scanning this code, the scanner is connected to the charging station.



For more details please refer to the manual of SICK AG (www.SICK.com).

9 Operation

 WARNING	Hot surfaces ! Non-compliance may result in minor burns. In ambient temperatures exceeding +45 °C the surface of the device may heat up. <ul style="list-style-type: none">• Do not touch the device.
	

The barcode scanners are operational once connected to a power supply (handheld barcode scanner) or once the battery has been inserted (Bluetooth barcode scanner).

9.1 Switching on device

- Press scanning button.
The barcode scanner will be activated.

9.2 Switching off the device

Switching off automatically

After a period of inactivity, the barcode scanner will automatically switch to standby mode. After a period in standby mode, the barcode scanner will be switched off automatically.

Switching off manually

To put the barcode scanner into standby mode or switch it off manually, scan the associated barcode command.

	Functions are programmed individually. Please refer to the programming information contained in the manual of SICK AG (www.SICK.com). This manual contains all barcode commands that can be programmed.
---	---

9.3 Scanning barcode

- Press scanning button.
- Point barcode scanner towards barcode.
LED flashes green once, and one acoustic signal is issued (standard setting) to confirm successful scanning of the barcode.

9.4 Charging Bluetooth barcode scanner

⚠ DANGER

Explosion hazard due to use of charging station not certified for hazardous areas.

Non-compliance may result in fatal or serious injuries.

- Only use explosion-protected charging station type IDMx61-BT-Base-AZ1 in hazardous areas.

NOTE

Malfunction or damage to the device due to incorrect charging of Bluetooth barcode scanner!

Non-compliance may result in material damage and malfunction.

- Make sure battery is placed inside scanner (see chapter [Replacing battery of Bluetooth barcode scanner](#)).
- Place scanner on charger.



Other charging stations are available for charging the explosion-protected wireless scanner in non-hazardous areas (see chapter [4.1.3 Overview charging stations](#)).

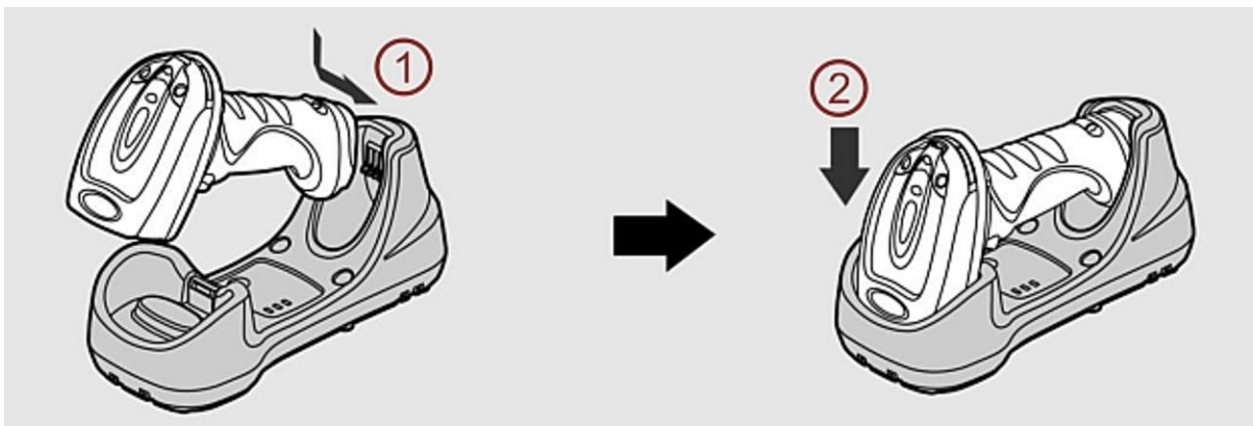

- Place Bluetooth barcode scanner on charging station (1) as shown in illustration so that the charging contacts of scanner and charging station are connected.
- Push down scanner head (2).
Status LED is lit and charging starts if the scanner has been correctly placed onto the charging station.



For status indicators see chapter [4.3 LEDs and acoustic signals](#).

10 Maintenance, servicing and repair

 DANGER	<p>Explosion hazard due to incorrect maintenance or repair ! Non-compliance may result in fatal or serious injuries.</p> <ul style="list-style-type: none"> • Ensure the atmosphere is non-explosive. • Make sure that the barcode scanner is not damaged. • Disconnect the handheld barcode scanner from the power supply. • Do not remove battery from Bluetooth barcode scanner in hazardous areas.
---	---

 WARNING 	<p>Hot surfaces at the device ! Non-compliance may result in minor burns. In ambient temperatures exceeding +45 °C the surface of the device may heat up.</p> <ul style="list-style-type: none"> • Do not touch the device.
---	---

It is the responsibility of the operator of an electrical plant in a hazardous environment to have the plant serviced. Please also note the relevant national rules and regulations.

- Associated equipment is subject to maintenance, service and testing according to directives 1999/92/EC, IEC/EN 60079-19, IEC/EN 60079, -17 and BetrSichVer (Betriebssicherheitsverordnung - Occupational Safety and Health).

10.1 Servicing

When servicing the device, check the following points in addition to those stipulated in the national regulations:

- Whether the enclosure has cracks or other visible signs of damage
- That all cables and conductors are correctly connected and undamaged
- Compliance with permitted temperature range
- Mounting fits securely, all screws tightened fast
- Ensure the device is used as intended

10.1.1 Replacing battery of Bluetooth barcode scanner

 DANGER	<p>Explosion hazard when replacing battery in hazardous area ! Non-compliance may result in fatal or serious injuries.</p> <ul style="list-style-type: none"> • Do not replace battery in hazardous areas. • Take Bluetooth barcode scanner into safe area.
---	--

	<p>Charge new batteries for 8 hours prior to first use.</p>
---	---

Opening battery compartment



Item	Designation
1	Screw for lid of battery compartment



Lid not easily removable, some force needed

- Unscrew lid screw (1).
- Remove lid of battery compartment.

Inserting battery



Item	Designation
1	Open battery compartment
2	Battery
3	Protective cap
4	Strap

- If there is a battery, pull on strap to remove battery.
- Remove protective cap (3) of replacement battery (2).
- Insert replacement battery (2) with contacts first with an audible click. 4 acoustic signals confirm that battery has been correctly inserted (provided battery is charged).

Closing battery compartment

- Screw lid onto battery compartment.

10.1.2 Charging Bluetooth barcode scanner

For how to charge the battery of the Bluetooth barcode scanner see chapter [9.4 Charging Bluetooth barcode scanner](#).

10.2 Maintenance

The devices are maintenance-free across their entire lifespan.

10.3 Repair

Users cannot repair the devices.

- Any repairs must only be carried out by R. STAHL.

11 Returning the device

Only return or package the devices after consulting R. STAHL. Contact the responsible representative from R. STAHL. R. STAHL's customer service is available to handle returns if repair or service is required.

Contact customer service via E-mail or telephone:

- E: service.dehm@r-stahl.com
- T: +49 221 76806 3000

Requesting a RMA ticket via our website:

- Go to r-stahl.com.
- Under "Support" > "RMA" > select "RMA-REQUEST".
- Fill out the form and send it in.
- You will automatically receive an E-mail with an RMA ticket.
- Print out the RMA ticket.
- Clearly copy the RMA number onto the outside of the package.
- Send the device with the RMA ticket included in the package to R. STAHL HMI Systems GmbH (see chapter [1.1 Manufacturer](#) for the address).

12 Cleaning

- Check the device for damage before and after cleaning it. Decommission damaged devices immediately.
- Devices located in hazardous areas may only be cleaned with a damp cloth to avoid electrostatic charge.
- When cleaning with a damp cloth, use water or mild, non-abrasive, non-scratching cleaning agents.
- Do not use abrasive cleaning agents or solvents.
- Never clean the device with a strong water jet, such as a pressure washer.

13 Accessories

NOTE	<p>Malfunction or damage to the device due to the use of non-original components. Non-compliance may result in material damage.</p> <ul style="list-style-type: none"> • Only use original accessories by the manufacturer.
-------------	--

The accessories listed below are available / necessary for assembly:

Accessories	Order number	Description / application	Cable length / other information	
Connection cable	VB-IDM160-RS232-SR-1.8m	Connection cable between handheld barcode scanner and Binder coupling for ET-/MT-xx8	max. 1.8 m	
	VB-IDM160-RS232-SR-3.6m		max. 3.6 m	
	VB-IDMx60-RS232-1.8m	Connection cable between handheld barcode scanner and Binder fixed socket at VM125-ex-RS232-*	max. 1.8 m	
	VB-IDMx60-RS232-3.6m		max. 3.6 m	
	VB-IDMx60-USB-1.8m	Connection cable between handheld barcode scanner and Binder fixed socket at VM125-ex-USB-*	max. 1.8 m	
	VB-IDMx60-USB-3.6m		max. 3.6 m	
	VB-IDMx6x-Base-RS232-SR-1.8m-Z1	Connection cable for charging station and Binder coupling for ET-/MT-xx8	max. 1.8 m	
	VB-IDMx6x-Base-RS232-SR-3.8m-Z1		max. 3.6 m	
	VB-IDMx6x-Base-VM-RS232-1.8m-Z1	Connection cable for charging station and VM125-ex-RS232-*	max. 1.8 m	
	VB-IDMx6x-Base-VM-RS232-3.6m-Z1		max. 3.6 m	
	VB-IDMx6x-Base-VM-USB-1.8m-Z1	Connection cable for charging station and VM125-ex-USB-*	max. 1.8 m	
	VB-IDMx6x-Base-VM-USB-3.6m-Z1		max. 3.6 m	
	Connection cable	VB-IDMx6x-EXT-3.0m-Z1	Extension cable between <ul style="list-style-type: none"> • handheld barcode scanner and Binder fixed socket • charging station and power supply module <p style="color: red;">Do not use with ET-/MT-xx8 !</p>	max. 3 m / straight cable
		VB-IDMx6x-EXT-6m-Z1		max. 6 m / spiral cable

Accessories	Order number	Description / application	Cable length / other information
Fixed socket	IDMx6x-Socket-3+PE	Binder flanged socket with screw connector for scanner cable	number of poles = 3 + PE
Adapter cable	VB-IDMx6x-SOCKET-RS232-0.5m	Adapter cable for barcode scanner, connection between ET-/MT-xx8 and IDMx6x connection cable, open end at Binder coupling	0.5 m / straight
Tripod	IDM160-tripod	Tripod for handheld barcode scanner	–
Deskholder	IDM160-Deskholder	Deskholder for handheld barcode scanner	–
Power supply	DSP-IDM160-DC5V	Non-Ex, for non-Ex charging station	–
Battery	IDM160-BT-ex-Lion	Replacement battery for Bluetooth barcode scanner	–

14 Appendix A

14.1 Technical data

14.1.1 Handheld barcode scanner

Handheld barcode scanner	IDM164-Z1	IDM264-Z1
Design	Handheld barcode scanner (wired)	
Version	linear imager	two-dimensional imager
Barcode types (scannable)	one-dimensional 1D (barcode and stacked code) (PDF417)	one- and two-dimensional 1D and 2D (barcode and stacked code) (PDF417)
light source	Visible red light, 630nm	
Scan frequency	500 Hz	60 Hz
Reader distance	20 ... 850 mm	30 ... 160 mm
Code resolution (depending on code)	approx. ≥ 0.076 mm	approx. ≥ 0.13 mm
Resistance to light interference	100.000 lx	
Indications		
Visual	2x LED (connection LED / status LED)	
acoustic	Beeper / buzzer (can be switched off)	
Connection cable		
at VM125-ex-RS232-*	VB-IDMx60-RS232-x.xml	
at VM125-ex-USB-*	VB-IDMx60-USB-x.xml	
Interface support (via supply module)	RS-232 / RS-422 / USB	
Shock	50 drops from a height of 2 m onto a concrete surface	
Ambient temperature	-20 °C to +50 °C	
Storage temperature	-30 °C to +70 °C	-40 °C to +70 °C
permitted humidity	± 95 %, non-condensing	
Degree of protection	IP65	
Dimensions (W x H x D)	104 mm x 185 mm x 76 mm	
Weight	200 g (without cable)	

14.1.1.1 Electrical data

Electrical data	IDM164-Z1			IDM264-Z1	
	VB-IDMx60-RS232-SR-x.8m	VB-IDMx60-RS232-x.8m	VB-IDMx60-USB-x.8m	VB-IDMx60-RS232-x.8m	VB-IDMx60-USB-x.8m
power supply cable	VB-IDMx60-RS232-SR-x.8m	VB-IDMx60-RS232-x.8m	VB-IDMx60-USB-x.8m	VB-IDMx60-RS232-x.8m	VB-IDMx60-USB-x.8m
Maximum input voltage U_i	5.6 V	4.9 V	4.9 V	5.6 V	5.6 V
Maximum input current I_i	480 mA	480 mA	480 mA	1180 mA	1180 mA
Maximum input power P_i	1.25 W	1.25 W	1.25 W	4.5 W	4.5 W
Maximum internal inductance L_i	negligible				
Maximum internal capacitance C_i	46 μ F	141 μ F	141 μ F	373 μ F	373 μ F

14.1.2 Bluetooth barcode scanner

Bluetooth barcode scanner	IDM164-BT-Z1	IDM264-BT-Z1
Design	Barcode scanner (Bluetooth)	
Version	Linear imager scanner	two-dimensional imager
Barcode types (scannable)	one-dimensional 1D (barcode and stacked code) (PDF417)	one- and two-dimensional 1D and 2D (barcode and stacked code) (PDF417)
Charging station	IDMx64-BT-Base-Z1 IDMx61-BT-Base-A IDMx61-Base-A	
Current consumption	330 mA (standby 80 / 130 mA; peak 500 mA)	
Battery	Lithium ion battery 3.6 V; 2250 mAh or 1500 mAh	
Battery power	approx. 60,000 scans when fully loaded	
Bluetooth		
Function	Bluetooth V4.0 EDR, class 1	
Range	approx. 30 m	
Frequency range	2.4 ... 2.4835 GHz (ISM band)	
light source	visible red light (630 nm)	

Scan frequency	500 Hz	60 Hz
Reader distance	20 ... 850 mm	30 ... 160 mm
Code resolution (depending on code)	approx. ≥ 0.076 mm	approx. ≥ 0.13 mm
Resistance to light interference	100.000 lx	
Indications		
Visual	2x LED (connection LED / status LED)	
acoustic	Beeper / buzzer (can be switched off)	
Connection cable		
at VM125-ex-RS232-*	VB-IDMx6x-Base-VM-RS232-1.8m-Z1	
at VM125-ex-USB-*	VB-IDMx6x-Base-VM-USB-1.8m-Z1	
Interface support (via supply module)	RS-232 / RS-422 / USB	
Shock	50 drops from a height of 2 m onto a concrete surface	
Ambient temperature	-20 °C to +50 °C	
Storage temperature	-30 °C to +70 °C	-40 °C to +70 °C
Degree of protection	IP65	
Dimensions (W x H x D)	104 mm x 185 mm x 76 mm	
Weight	260 g (without cable)	

14.1.2.1 Electrical data

Electrical data	IDM164-BT-Z1	IDM264-BT-Z1
Maximum input voltage U_i	4.2 V	
Maximum input current I_i	1071 mA	
Maximum input power P_i	4.5 W	
Maximum internal inductance L_i	negligible	
Maximum internal capacitance C_i	401 μ F	1180 μ F

14.1.2.2 Charging station

Charging station	IDMx64-BT-Base-Z1	IDMx61-BT-Base-A	IDMx61-Base-A
Design	Ex-protected Zone 1, 21 without cable	Non-Ex, without cable	Non-ex, without cable no Bluetooth
Operating voltage	4.9 V DC	5 V DC	
Current consumption	see Ex data	85 mA (in standby)	
Indications			
Visual	2x LED (operating LED / status LED)		
acoustic	Acoustic signal		
Interfaces	RS-232 or USB		
Bluetooth			
Function	Bluetooth V4.0 EDR, class 1		
Frequency range	2.4 ... 2.4835 GHz (ISM band)		
Ambient temperature	-20 °C to +50 °C		
Storage temperature	-30 °C to +70 °C		

14.1.2.3 Electrical data

Electrical data	IDMx64-BT-Base-Z1
Maximum input voltage U_i	5.5 V
Maximum input current I_i	480 mA
Maximum input power P_i	1.25 W
Maximum internal inductance L_i	negligible
Maximum internal capacitance C_i	190.3 μ F

15 Appendix B

15.1 Safety data

15.1.1 Handheld barcode scanner

15.1.1.1 IDM164-Z1

with connection cable VD-IDM160-RS232-SR-*			
max. input voltage	U_i	=	5.6 V
max. input current	I_i	=	480 mA
max. input power	P_i	=	1.25 W
max. internal inductance	L_i	≤	negligible
max. internal capacitance	C_i	≤	46 μF

with connection cable VB-IDMx60-RS232-*			
max. input voltage	U_i	=	4.9 V
max. input current	I_i	=	480 mA
max. input power	P_i	=	1.25 W
max. internal inductance	L_i	≤	negligible
max. internal capacitance	C_i	≤	112.4 μF

with connection cable VB-IDMx60-USB-*			
max. input voltage	U_i	=	4.9 V
max. input current	I_i	=	480 mA
max. input power	P_i	=	1.25 W
max. internal inductance	L_i	≤	negligible
max. internal capacitance	C_i	≤	112.4 μF

15.1.1.2 IDM264-Z1

with connection cable VB-IDMx60-RS232-*			
max. input voltage	U_i	=	5.6 V
max. input current	I_i	=	1140 mA
max. input power	P_i	=	4.5 W
max. internal inductance	L_i	≤	negligible
max. internal capacitance	C_i	≤	869 μF

with connection cable VB-IDMx60-USB-*			
max. input voltage	U_i	=	5.6 V
max. input current	I_i	=	1180 mA
max. input power	P_i	=	4.5 W
max. internal inductance	L_i	≤	negligible
max. internal capacitance	C_i	≤	869 μF

15.1.2 Charging station IDMx64-BT-Base-Z1

max. input voltage	U_i	=	5.5 V
max. input current	I_i	=	480 mA
max. input power	P_i	=	1.25 W
max. internal inductance	L_i	≤	negligible
max. internal capacitance	C_i	≤	190.3 μF

with connection cable VB-IDMx6x-Base-RS232-SR-*-Z1			
max. input voltage	U_i	=	5.6 V
max. input current	I_i	=	480 mA
max. input power	P_i	=	1.25 W
max. internal inductance	L_i	≤	negligible
max. internal capacitance	C_i	≤	46 μF

16 Appendix C

16.1 Proof of intrinsic safety

Proof of intrinsic safety for connection of barcode scanners with supply modules type VM125-ex-* and HMI devices ET-/MT-xx8, device platform SHARK.

16.1.1 General information

Proof of intrinsic safety is given on the basis of the IEC/EN 60079-14 and the standards referred to therein. In particular, we refer to Chapter 12 "Additional requirements for type of protection i - intrinsic safety" in IEC/EN 60079-14.

Proof has been produced on the basis of the Certificate of Conformity according to IEC/EN 60079-0 and IEC/EN 60079-11 or the EC Type Examination Certificate according to the 2014/34/EU directive and the comparison of the safety-relevant data listed therein.

The following Type Examination Certificates were used:

Device		Type Examination Certificate
IDM164-Z1 and IDM264-Z1	—	IBExU16ATEX1002
IDM164-BT-Z1 and IDM264-BT-Z1	—	IBExU16ATEX1003
VM125-ex-*	—	IBExU16ATEX1004
SHARK (ET-/MT-xx8)	—	BVS 14 ATEX E 134 X

The relevant test body has listed **all** conditions applicable to intrinsic safety in the type examination certificates.

For example, if a type examination certificate for a specific device only lists the applicable voltage (U_i), this means that intrinsic safety is guaranteed for connections if the associated power supply device does not exceed this voltage level (U_o is smaller than / equal to U_i).

Other output parameters defined in the test certificate of the power supply device (e.g. I_o , P_o) are irrelevant to intrinsic safety concerns.



The data listed in this document **do not** absolve the installer / operator of each system from their duty and responsibility to observe the applicable statutory requirements, directives and regulations. In any case, the associated due diligence remains the responsibility of the installer and / or the operator.

16.1.2 Connections

Examination of the voltage, current, capacitance and inductance values of all circuits to establish the connection between the barcode scanners with a standard cable length of 1.8 m or 3.6 m and the supply modules or the HMI device.

 DANGER	<p>Explosion hazard when exceeding electric parameters ! Non-compliance may result in fatal or serious injuries.</p> <ul style="list-style-type: none"> Do not use VB-IDM160-EXT-* extension cable for the connection of the handheld barcode scanners or the charging station to the SHARK device platform devices (ET-/MT-xx8). Only use a maximum cable extension of 1 m.
---	---

If the installer or operator extend the standard cable at their own instigation, they must take into account the additional C and L cable values for proof of intrinsic safety.

	Please note that we can in no way guarantee the functionality of such a cable extension.
---	--

16.1.2.1 Handheld barcode scanner

a) VM125-ex-RS232-* with IDM164-Z1

Source / active*		==>	Sink / passive
VM125-ex-RS232-*		VB-IDMx60-RS232-x.xm	IDM164-Z1
Connection Ex i			Scanner connection
U _o = 4.9 VDC		≤	U _i = 4.9 VDC
I _o = 440 mA		≤	I _i = 480 mA
P _o = 1.17 W		≤	P _i = 1.25 W
Co[μF] IIC =	113	≥	Ci = 112.4 μF
Lo[mH] IIC =	0.1	≥	Li = negligible
Co[μF] IIB =	1000	≥	Ci = 112.4 μF
Lo[mH] IIB =	1.3	≥	Li = negligible

C_o and L_o pairs directly above / underneath each other may be used.

b) VM125-ex-USB-* with IDM164-Z1

Source / active*		==>	Sink / passive
VM125-ex-USB-*		VB-IDMx60-USB-x.xm	IDM164-Z1
Connection Ex i			Scanner connection
U _o = 4.9 VDC		≤	U _i = 4.9 VDC
I _o = 440 mA		≤	I _i = 480 mA
P _o = 1.17 W		≤	P _i = 1.25 W
Co[μF] IIC =	113	≥	Ci = 112.4 μF
Lo[mH] IIC =	0.1	≥	Li = negligible
Co[μF] IIB =	1000	≥	Ci = 112.4 μF
Lo[mH] IIB =	0.53	≥	Li = negligible

C_o and L_o pairs directly above / underneath each other may be used.

c) VM125-ex-RS232-* -600mA with IDM264-Z1

Source / active*		==>	Sink / passive
VM125-ex-RS232-* -600mA		VB-IDMx60-RS232-x.xm	IDM264-Z1
Connection Ex i			Scanner connection
U _o = 4.9 VDC		≤	U _i = 5.6 VDC
I _o = 710 mA		≤	I _i = 1140 mA
P _o = 1.95 W		≤	P _i = 4.5 W
Co[μF] =	1000 for IIB	≥	Ci = 869 μF
Lo[mH] =	0.2	≥	Li = negligible

C_o and L_o pairs directly above / underneath each other may be used.

 DANGER	<p>Explosion hazard when exceeding electric parameters ! Non-compliance may result in fatal or serious injuries.</p> <ul style="list-style-type: none"> In explosion group IIC, do not use IDM264-Z1 handheld barcode scanner together with supply module VM125-ex-RS232-* -600mA.
---	---

d) ET-/MT-xx8 RS232 (X32) with IDM164-Z1

Source / active*		==>	Sink / passive
ET-/MT-xx8 RS232 (X32)		VB-IDM160-RS232-SR-x.xml	IDM164-Z1
Connection X32			Scanner connection
U _o = 5.36 VDC		≤	U _i = 5.6 VDC
I _o = 436 mA		≤	I _i = 480 mA
P _o = 1.235 W		≤	P _i = 1.25 W
Co[μF] =	65	≥	Ci = 46 μF
Lo[μH] =	1	≥	Li = negligible

C_o and L_o pairs directly above / underneath each other may be used.

16.1.2.2 Bluetooth barcode scanner

a) VM125-ex-RS232-* with IDM164-BT-Z1 or IDM264-BT-Z1

Source / active*		==>	Sink / passive
VM125-ex-RS232-*		VB-IDMx6x-Base-VM-RS232-1.8m-Z1	IDMx64-BT-Base-Z1
Connection Ex i			Charging station connection
U _o = 4.9 VDC		≤	U _i = 5.5 VDC
I _o = 440 mA		≤	I _i = 480 mA
P _o = 1.17 W		≤	P _i = 1.25 W
Co[μF] IIB =	1000	≥	Ci = 190.3 μF
Lo[mH] IIB =	1.3	≥	Li = negligible

C_o and L_o pairs directly above / underneath each other may be used.



Explosion hazard when exceeding electric parameters !

Non-compliance may result in fatal or serious injuries.

- In explosion group IIC, do not use the IDM264-BT-Z1 Bluetooth barcode scanner with the VM125-ex-RS232-*-600mA supply module .

b) VM125-ex-USB-* with IDM164-BT-Z1 or IDM264-BT-Z1

Source / active*		==>	Sink / passive
VM125-ex-USB-*		VB-IDMx6x-Base-VM-USB-1.8m-Z1	IDMx64-BT-Base-Z1
Connection Ex i			Charging station connection
U _o = 4.9 VDC		≤	U _i = 5.5 VDC
I _o = 440 mA		≤	I _i = 480 mA
P _o = 1.17 W		≤	P _i = 1.25 W
Co[μF] IIB =	1000	≥	Ci = 190.3 μF
Lo[mH] IIB =	0.53	≥	Li = negligible

C_o and L_o pairs directly above / underneath each other may be used.

 DANGER	<p>Explosion hazard when exceeding electric parameters ! Non-compliance may result in fatal or serious injuries.</p> <ul style="list-style-type: none"> In explosion group IIC, do not use the IDM264-BT-Z1 Bluetooth barcode scanner with the VM125-ex-RS232-*600mA supply module .
---	---

c) ET-/MT-xx8 RS232 (X32) with IDM164-BT-Z1 or IDM264-BT-Z1

Source / active*		==>	Sink / passive
ET-/MT-xx8 RS232 (X32)		VB-IDMx6x-Base-RS232-SR-x.xm-Z1	IDMx61-BT-Base-Z1
Connection X32			Charging station connection
U _o = 5.36 VDC		≤	U _i = 5.6 VDC
I _o = 436 mA		≤	I _i = 480 mA
P _o = 1.235 W		≤	P _i = 1.25 W
Co[μF] =	65	≥	Ci = 46 μF
Lo[μH] =	1	≥	Li = negligible

C_o and L_o pairs directly above / underneath each other may be used.

17 Appendix D

17.1 Disposal / Restricted substances

Disposal of old electric and electronic devices, packaging and used parts is subject to regulations valid in the country in which the device has been installed.

- Separate materials for recycling.

For countries under the jurisdiction of the EU the corresponding WEEE directive applies.

The devices are classified according to the table below:

Directive	WEEE II Directive 2012/19/EU
Valid	from 2018-08-15
Category	SG6 Small IT and telecommunications devices <50 cm

R. STAHL HMI Systems GmbH meets the requirements of directive 2012/19/EU (WEEE) and is registered under the number DE 15180083.

We shall take back our devices according to our General Terms and Conditions.

17.1.1 Declaration of substances and restricted substances

The present declaration is based on the procedure described in the international standard and directives as listed in the table below:

- IEC 62474 : 2018 (DIN EN IEC 62474 : 2019-09)
- (EG) Nr. 1907/2006 (REACH)
- Directive 2011/65/EU (RoHS)

17.1.1.1 Declarable substance groups

Component	Designation	Mass (g)	Declarable Substance Groups and Substances (IEC 62474 database)	CAS No.	Mass %	Exemption (acc. to directive)
-	-	-	No SVHC present	-	-	-

17.1.1.2 RoHS directive 2011/65/EC

The devices meet the requirements of RoHS Directive 2011/65/EU.

18 Appendix H

18.1 Declarations of conformity

18.1.1 EU

18.1.1.1 Handheld barcode scanner IDMx64-Z1

EU Konformitätserklärung
EU Declaration of Conformity
Déclaration de Conformité UE



R. STAHL HMI Systems GmbH • Adolf-Grimme-Allee 8 • 50829 Köln, Germany

erklärt in alleiniger Verantwortung, declares in ist sole responsibility, déclare sous sa seule responsabilité,

dass das Produkt: **Barcodescanner**
 that the product: *Barcode scanner*
 que le produit: *Lecteur de codes-barres*

Typ(en), type(s), type(s): **IDM164-Z1,
 IDM264-Z1**

mit den Anforderungen der folgenden Richtlinien und Normen übereinstimmt.
 is in conformity with the requirements of the following directives and standards.
 est conforme aux exigences des directives et des normes suivantes.

Richtlinie(n) / Directive(s) / Directive(s)	Norm(en) / Standard(s) / Norme(s)
2014/34/EU ATEX-Richtlinie 2014/34/EU <i>ATEX Directive</i> 2014/34/UE <i>Directive ATEX</i> <i>Official Journal of the EU L96, 29/03/2014, p. 309–356</i>	EN IEC 60079-0:2018 EN 60079-11:2012 EN 60079-28:2015

Kennzeichnung, marking, marquage:

Typ IDM164-Z1
 II 2G Ex ib IIB T4 Gb
 II 2D Ex ib IIIC T135°C Db

Typ IDM264-Z1
 II 2G Ex ib op is IIB T4 Gb
 II 2D Ex ib op is IIIC T135°C Db

CE0158

EU Baumusterprüfbescheinigung:
EU Type Examination Certificate:
Attestation d'examen UE de type:

BExU16ATEX1002
 (IBExU Institut für Sicherheitstechnik GmbH
 Fuchsmühlenweg 7, 09599 Freiberg, Germany NB 0637)

2014/30/EU EMV-Richtlinie 2014/30/EU <i>EMC Directive</i> 2014/30/UE <i>Directive CEM</i> <i>Official Journal of the EU L96, 29/03/2014, p. 79–106</i>	EN 61000-6-2 : 2019 DIN EN 61000-6-4 : 2020
--	--

2011/65/EU RoHS-Richtlinie 2011/65/EU <i>RoHS Directive</i> 2011/65/UE <i>Directive RoHS</i> <i>Official Journal of the EU L174, 1/07/2011, p. 88–110</i>	EN IEC 63000:2018
---	-------------------

Für spezifische Merkmale und Bedingungen siehe Betriebsanleitung.
 For specific characteristics and conditions see operating instructions.
 Pour les caractéristiques et conditions spécifiques, voir le mode d'emploi.

Unterszeichnet für und im Namen von: / signed for and on behalf of: / signé pour et au nom de:
R. STAHL HMI Systems GmbH

Köln, 2023-06-20

i.V.

A. Jung
Alexander Jung
 Director R&D

i.V.

Nabil Benighil
Nabil Benighil
 Head of Certification

Ort und Datum
Place and date
Lieu et date

18.1.1.2 Bluetooth barcode scanner IDMx64-BT-Z1

Not available yet

18.1.1.3 Charging station IDMx61-BT-Base-A (Non-Ex)

EU-Konformitätserklärung
EU Declaration of Conformity
Déclaration de Conformité UE



R. STAHL HMI Systems GmbH • Adolf-Grimme-Allee 8 • 50829 Köln, Germany

erklärt in alleiniger Verantwortung, *declares in its sole responsibility, déclare sous sa seule responsabilité,*

dass das Produkt: **Basisladestation**
that the product: Charging station
que le produit: Station de charge

Typ(en), *type(s)*, *type(s)*: **IDMx61-BT-Base-A**

mit den Anforderungen der folgenden Richtlinien und Normen übereinstimmt.
is in conformity with the requirements of the following directives and standards.
est conforme aux exigences des directives et des normes suivantes.

Richtlinie(n) / Directive(s) / Directive(s)		Norm(en) / Standard(s) / Norme(s)
Kennzeichnung <i>Marquing</i> <i>Marquage</i>		CE
EMV-Richtlinie <i>EMC Directive</i> <i>Directive CEM</i>	2014/30/EU 2014/30/EU 2014/30/UE	EN 301489-1 V2.2.0:2017 EN 301489-17 V3.2.0:2017
Funkanlagen Richtlinie <i>RED Directive</i> <i>Directive RED</i>	2014/53/EU 2014/53/EU 2014/53/UE	
Produktnormen nach Niederspannungsrichtlinie: <i>Product standards according to Low Voltage Directive:</i> <i>Normes des produit pour la Directive Basse Tension:</i>		EN 62368-1:2014
Produktnormen nach RoHS-Richtlinie (2011/65/EU): <i>Product standards according to RoHS Directive:</i> <i>Normes des produit pour la Directive RoHS:</i>		EN IEC 63000:2018

Für spezifische Merkmale und Bedingungen siehe Betriebsanleitung.
For specific characteristics and conditions see operating instructions.
Pour les caractéristiques et conditions spécifiques, voir le mode d'emploi.

Köln, 2022-01-13

Ort und Datum
Place and date
Lieu et date

i.V.

A. Jung
 Director R&D

i.V.

N. Benighil
 Certification Manager

18.1.1.4 Charging station IDMx64-BT-Base (Non-Ex)

EU Konformitätserklärung
EU Declaration of Conformity
Déclaration de Conformité UE



R. STAHL HMI Systems GmbH • Adolf-Grimme-Allee 8 • 50829 Köln, Germany
 erklärt in alleiniger Verantwortung, declares in its sole responsibility, déclare sous sa seule responsabilité,

dass das Produkt: **Bluetooth Basisladestation**
 that the product: *Bluetooth Charging station*
 que le produit: *Station de recharge Bluetooth*

Typ(en), type(s), type(s): **IDMx64-BT-Base NonEx**

mit den Anforderungen der folgenden Richtlinien und Normen übereinstimmt.
 is in conformity with the requirements of the following directives and standards.
 est conforme aux exigences des directives et des normes suivantes.

Richtlinie(n) / Directive(s) / Directive(s)	Norm(en) / Standard(s) / Norme(s)
Kennzeichnung, marking, marquage:	CE
2014/35/EU Niederspannungsrichtlinie: 2014/35/EU <i>Low Voltage Directive:</i> 2014/35/EU <i>Directive Basse Tension:</i> <i>Official Journal of the EU L96, 29/03/2014, p. 357–374</i>	EN 62368-1:2014/AC:2015 EN 62479:2010
2014/30/EU EMV-Richtlinie 2014/30/EU <i>EMC Directive</i> 2014/30/UE <i>Directive CEM</i> <i>Official Journal of the EU L96, 29/03/2014, p. 79–106</i>	EN 61000-6-2: 2019 DIN EN 61000-6-4: 2020
2014/53/EU Funkanlagen-Richtlinie 2014/53/EU <i>Radio Equipment Directive</i> 2014/53/UE <i>Directive Equipement Radioélectrique</i> <i>Official Journal of the EU L153, 22/05/2014, p. 62–106</i>	EN 300328 V2.2.2:2019 EN 303446-2 V1.2.1:2019 EN 301489-17 V3.2.4:2020
2011/65/EU RoHS-Richtlinie 2011/65/EU <i>RoHS Directive</i> 2011/65/UE <i>Directive RoHS</i> <i>Official Journal of the EU L174, 1/07/2011, p. 88–110</i>	EN IEC 63000:2018

Für spezifische Merkmale und Bedingungen siehe Betriebsanleitung.
 For specific characteristics and conditions see operating instructions.
 Pour les caractéristiques et conditions spécifiques, voir le mode d'emploi.

Unterzeichnet für und im Namen von: / signed for and on behalf of: / signé pour et au nom de:
R. STAHL HMI Systems GmbH

Köln, 2023-06-20

i.V.

Alexander Jung
 Director R&D

i.V.

Nabil Benighil
 Head of Certification

Ort und Datum
Place and date
Lieu et date

19 Appendix I

19.1 Release notes

The chapter entitled "Release Notes" contains all the changes made in every version of the Operating Instructions.

Version 01.04.00

- Deletion of old release notes
- OI change with new scanner versions in all sections
- Addition of note "Do not use in nuclear facilities" in section "Intended use"
- Addition of section "Compatibility matrix"
- Change of cable lengths in section "Accessories" from 3.8 m to 3.6 m
- Changes to "Extension cables" in section "Accessories"
- Addition of "VM125-ex-USB-*" versions in section "Overview supply modules"
- Update of diagram "Connection overview" scanners
- Addition of section "Colour coding of connection cable for handheld barcode scanner"
- Addition of section "PAIR mode"
- Deletion of general section "Disposal" since information included in section "Disposal / Restricted substances"
- Addition of declaration of conformity handheld barcode scanner IDMx64-Z1
- Addition of declaration of conformity charging station IDMx61-BT-Base-A (Non-Ex)
- Addition of declaration of conformity charging station IDMx64-BT-Base (Non-Ex)
- Bluetooth scanner data not yet adjusted / checked because certificates are still pending
- Formal corrections

R. STAHL HMI Systems GmbH
Adolf-Grimme-Allee 8
D 50829 Cologne

T:	(Sales Support)	+49 221 768 06 - 1200
	(Technical Support)	+49 221 768 06 - 5000
F:		+49 221 768 06 - 4200
E:	(Sales Support)	sales.dehm@r-stahl.com
	(Technical Support)	support.dehm@r-stahl.com

r-stahl.com
exicom.de



THE STRONGEST LINK.