



Operating Instructions



SHARK Device Platform

ET-xx8 / MT-xx8

Series 400 Panel PCs

Series 500 Thin Clients

Series 600 KVM Systems



THE STRONGEST LINK.

Doc. no.: 20141870000

HW-Rev. ET-/MT-4x8:	01.01.06
HW-Rev. ET-/MT-5x8:	01.01.06
HW-Rev. ET-/MT-6x8:	01.01.06

Operating Instructions Version:	01.02.07
Issue:	06.12.2023

Order number:	291293
---------------	--------

Table of contents

	Description	Page
	Table of contents	2
1	General information	7
1.1	Manufacturer	7
1.2	Legal notice	7
1.2.1	Trademark	7
1.2.2	Disclaimer	7
1.3	About these Operating Instructions	8
1.3.1	Target group	8
1.3.2	How to use this manual	8
1.3.3	Application	8
1.4	Further documents	8
1.5	Conformity with standards and regulations	9
1.5.1	Certificates	9
1.5.2	Approvals	9
	Europe (CE / ATEX)	9
	Global (IECEX)	9
	USA (NEC)	9
	Canada (CEC)	9
	China (CCC / CNEx)	9
	India (PESO)	9
	Australia (RCM)	9
	Marine / ship approval (ABS)	10
	Marine / ship approval (DNV)	10
	India (BIS)	10
	Korea (KCC / KCS)	10
1.5.3	Summary of applied standards	11
1.5.3.1	ATEX / IECEX ET-xx8	11
1.5.3.2	ATEX / IECEX MT-xx8	11
1.5.3.3	EMC directive 2014/30/EU	11
1.5.3.4	Radio equipment directive 2014/53/EU	11
1.5.3.5	Low voltage directive 2014/35/EU	11
1.5.3.6	RoHS directive 2011/65/EU	12
1.5.3.7	FM USA	12
1.5.3.8	FM Canada	12
2	Explanation of symbols	13
2.1	Symbols used in these Operating Instructions	13
2.2	Warning notes	13
2.3	Symbols on the device	14
3	Safety and security	15
3.1	Intended use	15
3.2	Predictable improper use	16
3.3	Personnel qualification	16
3.4	Special conditions of use	17
3.5	Residual risks	18

3.5.1	Explosion hazard	18
3.5.2	Risk of injury	19
3.5.3	Device damage	20
3.6	Industrial Security	20
4	Function and device design	21
4.1	Features and versions	21
4.1.1	Options	21
4.1.2	Display	21
4.1.3	Outdoor Installation	21
4.1.4	Card reader for access control	21
4.1.5	Other features	22
4.1.6	Accessories	22
4.2	Device design	22
4.3	Type code	23
4.3.1	Fieldsystem type key code	23
4.3.1.1	SERIES 400 / 500	23
4.3.1.2	SERIES 600	26
4.3.2	Display module type key code	28
4.3.3	E-Box module SERIES 400 / 500 type key code	30
4.3.4	E-box module SERIES 600 type key code	32
4.4	Dimensions	33
4.4.1	Front:	33
4.4.2	Page - VESA 200 Standard	33
4.4.3	Page - VESA 200 Top Connect	33
4.5	Terminal boxes	34
4.5.1	VESA 200 Standard	34
4.5.2	VESA 200 Top Connect	34
4.6	Operating elements	35
4.6.1	ET-/MT-x38 (15")	35
4.6.2	ET-/MT-x98 (21.5")	35
4.7	LED status display	35
4.8	Markings on the device	36
4.8.1	Position	36
4.8.2	Design of a type label (taking the field system type label as an example)	36
4.9	Approval label	37
4.9.1	Ex classification ATEX / IECEx	37
4.9.2	Ex classification FM USA	38
4.9.3	Ex classification FM Canada	38
4.9.4	Ex classification CCC China	39
4.9.5	Ex classification CNEEx China	39
4.9.6	Ex classification PESO	39
4.9.7	Ex classification KCS	40
5	Operating systems and drivers	41
5.1	Up to Windows 7	41
5.1.1	Licensing issues	41
5.2	Windows® 10 IoT Enterprise 2019 LTSC operating system	41

5.2.1	Recovery	41
5.2.2	Proprietary Windows installations and drivers	41
5.3	Data back-up	41
5.3.1	Recovery Stick	41
5.3.2	Back-up	42
5.3.3	Switching off / closing down	42
5.3.4	Loss of data	42
5.4	License sticker	43
5.5	UPDD touch driver	43
6	Transport and storage	44
7	Unpacking	44
8	Mounting and installation	45
8.1	Note on mounting and installation	45
8.2	Requirements for site of installation	45
8.3	Mounting types	45
8.4	Panel mount with xx8 Mounting-Kit	46
8.5	Installation	47
8.5.1	General information on electric connection	47
8.5.2	Connecting device to power supply	47
8.5.3	Grounding the device	48
8.5.4	Connecting data cable	48
8.5.5	Mounting the cover of the terminal boxes	48
8.5.6	Connecting associated equipment	48
8.5.7	Cable glands	49
8.5.8	Electric connections of interfaces X1 ... X9 and X31 ... X35	50
8.5.9	Details for electrical connection of Interface X10	50
8.6	Using USB interfaces	51
9	Initial start-up	52
10	(Re-) Commissioning	52
11	Operation	53
11.1	Operating the touch display	53
11.2	Switching the device on and off	54
11.2.1	Without optional on/off switch	54
11.2.2	With optional on/off switch (for SERIES 400 and 500 only)	54
11.3	Teaming function	54
12	Maintenance, overhaul and repair	55
12.1	Changing the battery	55
12.2	Servicing	55
12.3	Maintenance	56
12.4	Repair	56
12.4.1	Mounting / dismounting the modules	56
13	Returning the device	57
14	Cleaning	57
15	Disposal	57
16	Accessories	57
17	Appendix A	58
17.1	Technical data	58

17.1.1	General	58
17.1.2	Electrical data	58
17.1.3	Display	59
17.1.4	Ambient conditions	60
17.1.5	Mounting	61
17.1.6	Mechanical data VESA 200 Standard	61
17.1.7	Mechanical data VESA 200 Top Connect	61
17.2	Additional data for SERIES 400 / 500	62
17.2.1	General	62
17.2.2	Electrical data	62
17.2.3	Interfaces	63
17.3	Additional data for SERIES 600 KVM Systems	64
17.3.1	General	64
17.3.2	Electrical data	64
17.3.3	Interfaces	64
17.4	Transponder media table	65
17.5	Overview Hardware Revision ET-xx8 / MT-xx8	66
18	Appendix B	67
18.1	Connection values	67
18.2	Intrinsically safe interfaces (Ex ia)	67
18.2.1	X30 PB – on/off switch	67
18.2.2	X31 - Fan	67
18.2.3	X32 – Barcode / card reader	67
18.2.4	X33 / X34 – USB KB/M	69
18.2.5	X35 – USB	69
18.2.6	X36 / X37 – RF1 / RF2	69
18.3	Bluetooth – B1	70
18.4	RFID reader interface – RF1, RF2	70
18.5	Inherently safe optical interfaces (Ex op is)	70
18.5.1	X20 / X21 – FO 1 / FO 2 type FX	70
18.5.2	X20 / X21 – FO 1 / FO 2 type SX	70
18.5.3	X20 / X21 – FO 1 / FO 2 type LX	70
18.5.4	X22 – FO 3 type OSX	70
18.5.5	X22 – FO 3 type OLX	70
18.6	Non intrinsically safe interfaces (Ex e)	71
18.6.1	X1 – Power supply	71
18.6.2	X2 / X3 – copper1 / copper2	71
18.6.3	X4 – DC out	71
18.6.4	X5 – CAN	71
18.6.5	X6 – USB	71
18.6.6	X7 – RSxxx	71
18.6.7	X8	71
18.6.8	X9 – Audio / Video	71
18.6.9	X10 – SATA	71
19	Appendix C	72
19.1	Connection overview terminal assignment	72
19.1.1	Ex e terminal box / terminals	72

19.1.2	Ex i terminal box / terminals	74
20	Appendix D	76
20.1	Variation of operating temperature range	76
21	Appendix E	78
21.1	Disposal / Restricted substances	78
21.1.1	Declaration of substances and restricted substances	78
21.1.1.1	Declarable substance groups	78
21.1.1.2	ROHS directive 2011/65/EC	79
21.1.1.3	IMO Resolution MEPC.269(68)	79
22	Appendix F	80
22.1	Defective pixels	80
22.1.1	Terminology	80
22.1.2	Display specification	81
22.2	Optical specification front glass	82
22.2.1	Test criteria	82
22.3	Optical acceptance of surfaces	84
22.3.1	Optical acceptance glass	84
22.3.2	Optical acceptance printing	85
22.3.3	Optical acceptance, other surfaces	85
23	Appendix G	87
23.1	Panel mount with xx8 Mounting-Kit	87
23.2	Control Drawing – FM USA / Canada	88
23.3	Installation Instructions Requirements China	91
24	Attachment H	93
24.1	Declarations of EC conformity	93
24.1.1	EU	93
24.1.1.1	ET-xx8	93
24.1.1.2	MT-xx8	94
24.1.2	RCM	95
24.1.3	CCC	97
24.1.3.1	English version	97
24.1.3.2	Chinese version	108
25	Appendix I	119
25.1	Release notes	119

1 General information

1.1 Manufacturer

R. STAHL HMI Systems GmbH
Adolf-Grimme-Allee 8
50829 Köln
Germany

Sales Support

Telephone: +49 221 768 06 – 1200
E-mail: sales.dehm@r-stahl.com

Technical Support

Telephone: +49 221 768 06 – 5000
E-mail: support.dehm@r-stahl.com

General

Fax: +49 221 768 06 – 4200
Internet: r-stahl.com

1.2 Legal notice

1.2.1 Trademark

The terms and names used in this document are registered trademarks and / or products of the companies in question.

1.2.2 Disclaimer

- All rights reserved.
- This document may not be reproduced in whole or in part except with the written consent of the publisher.
- This document may be subject to change without notice.

Any warranty claims are limited to the right to demand amendments. Liability for any damage that might result from the contents of these instructions or all other documentation is limited to clear cases of premeditation.

We reserve the right to amend our products and their specifications at any time, provided it is in the interest of technical progress. The information in the current manual (online or on CD / DVD / USB-stick) or in the operating instructions included in the delivery applies.

1.3 About these Operating Instructions

1.3.1 Target group

These operating instructions are intended for the following groups of people:

- Project engineers
- Electricians and fitters
- Operators
- Operating staff
- Maintenance staff

1.3.2 How to use this manual

- Read these operating instructions, especially the safety notes, carefully before use.
- Take note of all other applicable documents (see also chapter [1.4 Further documents](#)).
- Keep the operating instructions throughout the service life of the device.
- Make the operating instructions accessible to operating and maintenance staff at all times.
- Pass the operating instructions on to each subsequent owner or user of the device.
- Update the operating instructions every time R. STAHL issues an amendment.

1.3.3 Application

Operating Instructions version:	01.02.07
Hardware revision:	ET-/MT-4x8: 01.01.06 ET-/MT-5x8: 01.01.06 ET-/MT-6x8: 01.01.06

The following operating instructions apply to the following systems:

ET-xx8 / MT-xx8	SERIES 400 Panel PC SERIES 500 Thin Clients SERIES 600 KVM Systems
-----------------	--

The original instructions are the German edition.
They are legally binding in all legal affairs.

1.4 Further documents

- Installation Manual ET-/MT-xx8 (IM_ET_MT-xx8)
- Installation Manual Top Connect ET-/MT-xx8 (IM_Top-Connect_xx8)
- Installation Manual Mounting-Kit xx8 (IM_Mounting-Kit_xx8)
- Installation Manual Module exchange xx8 (IM_Module_exchange_xx8)
- Compilation of Certificates xx8 (CE_ET_MT-xx8)



For documents in other languages see [r-stahl.com](https://www.r-stahl.com).

1.5 Conformity with standards and regulations

1.5.1 Certificates

	Certificates: r-stahl.com
	The device has IECEx approval. See IECEx homepage: https://www.iecex-certs.com/#/home .
	Further national certificates can be downloaded via the following link: https://r-stahl.com/de/global/support/downloads/

1.5.2 Approvals

The following approvals are valid for all devices:

Synonym	Scope of validity	Valid until	Certificate number
CE / ATEX	Europe	unlimited	BVS 14 ATEX E 134 X
IECEX	Global	unlimited	BVS 14.0116X
NEC	USA	unlimited	FM 16 US 0278 X
CEC	Canada	unlimited	FM 16 CA 0141 X
CCC	China	01.09.2025	2020312309000286
CNEEx		25.10.2027	CNEEx22.2713X

Synonym	Scope of validity	Valid until	Device	Certificate number
PESO	India	31.12.2023	ET-xx8	A/P/HQ/TN/104/5747 (P436617)
				CCE identification number P436617/1
		31.12.2023	MT-xx8	Certificate number A/P/HQ/TN/104/5750 (P436574)
	CCE identification number P436574/1			

Synonym	Scope of validity	Valid until	Note
RCM	Australia	unlimited	according to declaration of conformity

The following approvals are only valid for the SERIES 400 Panel PCs and the SERIES 500 Thin Clients:

Synonym	Scope of validity	Valid until	Certificate number
ABS	Marine / ship approval	21.10.2026	21-2166269-PDA
DNV	Marine / ship approval	26.11.2027	TAA00001E6

The following approvals are only valid for ET devices of SERIES 400 Panel PCs and of SERIES 500 Thin Clients:

Synonym	Scope of validity	Valid until	Certificate number
BIS	India	26.06.2024	R-41228087

The following approvals only apply to the model versions listed in the tables:

Synonym	Scope of validity	Valid until	Certificate number
KCC	Korea	unlimited	R-R-RS3-RSTAHL-HMI-01
Model version		Modules	
ET-598-2TX-231531F000M-B3010000000		ET-5x8-2TXACW00xxX00-P2R3M5I0S8E000 ET-x98-xxxB1C5x-D1T3O0E000	
MT-598-2TX-231531F000M-B3010000000		MT-5x8-2TXACW00xxX00-P2R3M5I0S8E000 MT-x98-xxxB1C5x-D1T3O0E000	
ET-598-2TX-231531L000M-B3010000000		ET-5x8-2TXACW00xxX00-P2R3M5I0S8E000 ET-x98-xxxB1C6x-D1T3O0E000	
MT-598-2TX-231531L000M-B3010000000		MT-5x8-2TXACW00xxX00-P2R3M5I0S8E000 MT-x98-xxxB1C6x-D1T3O0E000	

Synonym	Scope of validity	Valid until	Certificate number
KGS	Korea	unlimited	
Model version		Modules	
ET-598-2TX-231531F000M-B3010000000		ET-5x8-2TXACW00xxX00-P2R3M5I0S8E000 ET-x98-xxxB1C5x-D1T3O0E000	
MT-598-2TX-231531F000M-B3010000000		MT-5x8-2TXACW00xxX00-P2R3M5I0S8E000 MT-x98-xxxB1C5x-D1T3O0E000	
ET-598-2TX-231531L000M-B3010000000		ET-5x8-2TXACW00xxX00-P2R3M5I0S8E000 ET-x98-xxxB1C6x-D1T3O0E000	
MT-598-2TX-231531L000M-B3010000000		MT-5x8-2TXACW00xxX00-P2R3M5I0S8E000 MT-x98-xxxB1C6x-D1T3O0E000	
		Certificate number	
		21-KA4BO-0769X 21-KA4BO-0770X	
		21-KA4BO-0771X 21-KA4BO-0773X	
		21-KA4BO-0769X 21-KA4BO-0770X	
		21-KA4BO-0771X 21-KA4BO-0773X	

 The approved model versions for Korea are identical in their specification and differ only in terms of the area of application (zone - ET or MT code) and the protocol for the reader (F or L code).

 The importer have to use exception documents which are applied in Korea rule for Korea.
A corresponding example document, the so-called "Customer confirmation letter", is included in the CE_ET_MT-xx8 certificate compilation of the devices.

1.5.3 Summary of applied standards**1.5.3.1 ATEX / IECEx ET-xx8**

Standard	Classification
IEC 60079-0: 2012 + A1 : 2013	General requirements
IEC 60079-5: 2015	Protection by powder filling "q"
IEC 60079-7: 2015	Protection by increased safety "e"
IEC 60079-11: 2012	Protection by intrinsic safety "i"
IEC 60079-28: 2015	Optical radiation "op is"
IEC 60079-31: 2014	Protected by enclosures "t" (dust)
The product corresponds to requirements from:	
EN IEC 60079-0 : 2018	General requirements
EN IEC 60079-7 : 2015 + A1 : 2018	Protection by increased safety "e"

1.5.3.2 ATEX / IECEx MT-xx8

Standard	Classification
IEC 60079-0: 2012 + A1 : 2013	General requirements
IEC 60079-5: 2015	Protection by powder filling "q"
IEC 60079-7: 2015	Protection by increased safety "e"
IEC 60079-11: 2012	Protection by intrinsic safety "i"
IEC 60079-15: 2010	Type of protection "n"
IEC 60079-28: 2015	Optical radiation "op is"
IEC 60079-31: 2013	Protected by enclosures "t" (dust)
The product corresponds to requirements from:	
EN IEC 60079-0 : 2018	General requirements
EN IEC 60079-7 : 2015 + A1 : 2018	Protection by increased safety "e"
EN IEC 60079-15: 2020	Type of protection "n"

1.5.3.3 EMC directive 2014/30/EU

Standard	Classification
EN 61000-6-2 : 2005 + AC : 2005	Immunity
EN 61000-6-4 : 2007 + A1 : 2011	Emission

1.5.3.4 Radio equipment directive 2014/53/EU

Standard	Classification
ETSI EN 300328 V2.2.2 : 2019	Wideband transmission systems – data transmission equipment operating in the 2.4 GHz ISM band

1.5.3.5 Low voltage directive 2014/35/EU

Standard	Classification
EN 62368-1 : 2016 IEC 62368-1 : 2014	Audio / video, information and communication technology equipment – safety requirements

1.5.3.6 RoHS directive 2011/65/EU

Standard	Classification
EN IEC 63000 : 2018	Technical documentation for the assessment of electrical and electronic products with respect to the restriction of hazardous substances

1.5.3.7 FM USA



Standard	Classification
FM Class 3600: 2011	Electric equipment for use in hazardous areas - general requirements
FM Class 3616: 2011	Dust explosion protection electric equipment - general requirement
FM Class 3810: 2005	Electric equipment for the operation of measuring, control and laboratory equipment
ANSI/ISA 60079-0: 2013	General requirements
ANSI/UL 60079-5: 2016	Protection by powder filling "q"
ANSI/UL 60079-7: 2017	Protection by increased safety "e"
ANSI/ISA 60079-11: 2014	Protection by intrinsic safety "i"
ANSI/ISA 60079-15: 2013	Type of protection "n"
ANSI/ISA 60079-28: 2013	Optical radiation "op is"
ANSI/UL 60079-31: 2015	Protected by enclosures "t" (dust)
ANSI/IEC 60529: 2004	Degrees of protection provided by enclosure (IP code)

1.5.3.8 FM Canada



Standard	Classification
CAN/CSA-C22.2 No. 60079-0: 2015	General requirements
CAN/CSA-C22.2 No. 60079-5: 2016	Protection by powder filling "q"
CAN/CSA-C22.2 No. 60079-7: 2016	Protection by increased safety "e"
CAN/CSA-C22.2 No. 60079-11: 2014	Protection by intrinsic safety "i"
CAN/CSA-C22.2 No. 60079-15: 2016	Type of protection "n"
CAN/CSA-C22.2 No. 60079-31: 2015	Protected by enclosures "t" (dust)
CAN/CSA-C22.2 No. 60529: 2016	Degrees of protection provided by enclosure (IP code)
CAN/CSA-C22.2 No. 61010-1: 2004	Safety regulations for electric measuring, control and laboratory equipment - general requirements



2 Explanation of symbols

2.1 Symbols used in these Operating Instructions







Symbol	Meaning
	Handy hint for making work easier, important note
	Reference to another chapter, another section, another documentation or a web page.

2.2 Warning notes

 DANGER	Dangerous situation which can result in fatal or severe, life-changing injuries if the safety measures are not complied with.
 WARNING	Dangerous situation which can result in severe injuries if the safety measures are not complied with.
 CAUTION	Dangerous situation which can result in minor injuries if the safety measures are not complied with.
NOTE	Dangerous situation which can result in material damage if the safety measures are not complied with.

Symbol	Meaning
	Burn hazard
	Laser radiation hazard
	Electrostatic discharge hazard

2.3 Symbols on the device

Symbol	Meaning
	Device certified for hazardous areas according to ATEX directive.
	Device marking according to EU directive
0158	ID number of monitoring body
	Marking according to WEEE directive 2012/19/EU
	Marking according to FM (Factory Mutual) for approval in North America <ul style="list-style-type: none"> • C stands for Canada • US stands for United States
	Warning - important information
	Warning of hazardous voltage
	Connection for equipotential bonding

3 Safety and security

The device has been manufactured according to the state of the art of technology while observing recognised safety-related rules. When using the device, it is nevertheless possible for hazards to occur to life and limb of the user or third parties or for the device, environment or material assets to be compromised.

Only use the device under the following conditions:

- If it is not damaged
- As intended, while remaining aware of safety and hazards
- In accordance with these Operating Instructions

3.1 Intended use

The Series xx8 Shark device platform HMIs are operator stations suitable for industrial production in hazardous areas.

Depending on their version, the devices are certified for the following hazardous areas:

Series xx8	Hazardous area	Directive
ET	Zone 1, 2, 21 and 22 (EPL Gb, Db) Class I, Zone 1 & 2; Class I, Division 2; Zone 21 & 22	ATEX directive, IEC and Canadian requirements
	Class I and Class II, Division 2	acc. to American requirements
MT	Zone 2 and 22 (EPL Gc, Dc) Class I, Zone 2, Class I, Division 2, Zone 22	ATEX directive, IEC and Canadian requirements
	Class I and Class II, Division 2	acc. to American requirements

The SHARK device platform has been designed with particular focus on the harsh conditions prevalent in the oil and gas industry. The device can be used indoors as well as in outdoor areas. It is shock, vibration, saltwater and salt-spray proof.

The approved operating temperature ranges depend on the version:

- Standard: from -10 °C to +65 °C
- Outdoor installation (with integrated heater): from -40 °C to +65 °C

Depending on their configuration, the following versions with the SHARK device platform are available:

- Panel PC - SERIES 400
- Thin Clients - SERIES 500
- KVM Systems (Keyboard - Video - Mouse) - SERIES 600

The SHARK device platform consists of a display and an E-Box module that are mounted together. The display module generally consists of all display components, whereas the E-Box module generally consists of the other electronic parts.

The device platform communicates with automation systems and distributed control systems via Ethernet, WLAN or serial interfaces, and has additional interfaces for peripherals such as keyboards, pointing devices, RFID readers, barcode readers for material inventory or EM-STOP switches.

The device is not a panel-mount module. For applications that require degree of protection Ex e, Ex p or Ex tb, the device must be mounted together with the "xx8 Mounting-Kit".

Two terminal boxes for Ex e and Ex ia circuits are available for the connection of all external cables.

"Intended use" includes complying with these Operating Instructions and the other applicable documents, such as the data sheet. All other uses are only considered to be intended after being approved by R. STAHL.

3.2 Predictable improper use

The device may only be installed and connected by specifically trained personnel.

3.3 Personnel qualification

Qualified specialist personnel is required to perform the activities described in these Operating Instructions. This primarily applies to work in the following areas:

- Product selection and project engineering
- Mounting / dismounting the device
- Installation
- Commissioning
- Maintenance, cleaning

Specialists who perform these tasks must have a level of knowledge that meets applicable national or equivalent country-specific standards and regulations. Additional knowledge is required for any activity in hazardous areas !

R. STAHL recommends having a level of knowledge equal to that described in the following standards:

- IEC/EN 60079-14 (Electrical installations design, selection and erection)
- IEC/EN 60079-17 (Electrical installations, inspections and maintenance)
- IEC/EN 60079-19 (Equipment repair, overhaul and reclamation)

3.4 Special conditions of use

The intrinsically safe circuits are earthed. Equipotential bonding is required for the entire intrinsically safe circuits.

Devices with wireless interface

Type feature for devices with wireless interface:	W02, W05, W22, W55 or W25
Maximum transmission power of antenna	2 W (group IIC)
Connection terminal for antenna:	X36 and X37

The maximum transmission power is the result of: antenna gain, power loss in the cable and transmission power of the transmitter (X36 / X37), according to the data in these operating instructions.

The intrinsically safe circuits at terminals X36 and X37 are earthed. When connecting external antennae, please note the following earthing requirements for intrinsically safe circuits:

- EN 60079-14 of the National Electrical Code ANSI/NFPA 70
- Canadian Electric Code CSA C22.1

Requirements for plug connectors and switches

The covers of the terminal boxes are fitted with cable entries and blind plugs. As an option, they may be fitted with plug connectors and switches.

The devices must be certified individually for the respective type of protection and also have IP66.

Panel mount with xx8 Mounting-Kit

The devices can be mounted inside an enclosure with a suitable cut-out with the aid of fixing frame kits (xx8 Mounting-Kit). Where degree of protection Ex e, Ex p or Ex tb is required, the device must be mounted with a xx8 Mounting-Kit mounting frame (see chapter [8.4 Panel mount with xx8 Mounting-Kit](#)).

3.5 Residual risks

3.5.1 Explosion hazard

Despite the device's state-of-the-art design, explosion hazards cannot be entirely eliminated in hazardous areas.

- Perform all work steps in hazardous areas with the utmost care at all times !

Possible hazards ("residual risks") can be categorised according to the following causes:

Mechanical damage

The device may become damaged during transport, mounting or commissioning. This kind of damage may, for example, render the device's explosion protection partially or completely ineffective. This may result in explosions causing serious or even fatal injury.

- Do not commission a damaged device.
- Only transport the device in special transport packaging that reliably protects the device from external influences. Observe the ambient conditions when selecting the transport packaging (see chapter [17.1 Technical data](#)).
- Do not place any loads on the device.
- Check the packaging and the device for damage. Immediately report any damage to R. STAHL.
- Store the device ideally in its original packaging in a dry place (with no condensation), and make sure that it is stable and protected against the effects of vibrations and knocks.
- Do not damage the device or seals during its installation.

Excessive heat or electrostatic charge

- Operate the device only within the prescribed operating conditions (see chapter [4.7 Markings on the device](#) and chapter [17.1 Technical data](#)).
- Mount and install the device in such a way that it is always operated within the permissible temperature range.
- Do not use the device in strong charge-generating environments.
- Avoid friction and flow of particle streams.
- R. STAHL recommends you equip devices used outdoors or exposed to the elements with a protective roof or wall.
- Regularly inspect the device for a material change. If you spot any changes, test or replace the device.
- Do not paint or repaint the device yourself. Do not have the paintwork touched up by anyone other than the manufacturer.
- Comply with the area specification of EN/IEC 60079-0 when fitting additional plastic adhesive labels.
- Clean the device with a damp cloth only.
- Do not cover the display with protective foil.

Improper mounting, installation, commissioning, maintenance or cleaning

Basic work such as installation, commissioning, maintenance or cleaning of the device must always be performed in accordance with the applicable national regulations of the country of use and only by qualified persons. Otherwise, the explosion protection may be rendered ineffective. This may result in explosions causing serious or even fatal injury.

- Have the assembly, installation, commissioning and maintenance work performed by qualified and authorised persons only (see chapter [3.3 Personnel qualification](#)).
- Prior to commissioning, check the device is mounted correctly (see chapter [8 Mounting and installation](#)).
- Electrical circuits with Ex i type of protection may no longer be operated as electrical circuits with this type of protection after being operated with electrical circuits with other types of protection.
- Even when used in Zones 2 and 22, intrinsically safe devices of Zones 0, 1, 20 and 21 can be connected to the intrinsically safe signal circuits.
- Only connect the device to equipment which does not carry voltages higher than 250 VAC (50 - 60 Hz).
- Connect Ex i devices only to intrinsically safe terminals.
- In hazardous areas, always switch the electrical circuits and devices to a de-energised state before disconnecting or connecting and when mounting / dismantling.
- Do not change or modify the device.
- Any repair on the device is to be performed by R. STAHL only.
- Gently clean the device with a damp cloth only – do not use scratching, abrasive or aggressive cleaning agents or solutions.
- Never clean the device with a strong water jet, such as a pressure washer !

3.5.2 Risk of injury

Falling devices or components

The heavy device or components can fall during transport and mounting, causing severe injury to persons in the form of bruises and contusions.

- Use transporting and lifting equipment suitable for the size and weight of the device when transporting and mounting it.
- Observe the weight and the maximum load-bearing capacity of the device; see specifications on the shipping label or on the packaging.
- Use suitable mounting materials for mounting.

Electric shock

During operation and maintenance, high voltage is at times applied to the device. Because of this, the device must be de-energised during installation. Persons coming into contact with electrical lines carrying excessively high voltage can suffer severe electric shocks and, consequently, injuries.

- Only connect electrical circuits to suitable terminals.

3.5.3 Device damage

As a result of unsuitable operating conditions or careless contact the device or individual components may be damaged so significantly that the device does not operate correctly or fails completely.

- Do not subject the device to external heat sources or direct sunshine. Ensure that the maximum ambient temperature is never exceeded.
- Do not open the enclosure. The enclosure has been sealed permanently.

3.6 Industrial Security

Our products with Industrial Security functions support the secure operation of plants, systems and equipment. Protection against cyber threats requires an all-encompassing Industrial Security concept. The key to a successful concept is integrated implementation, continuous maintenance and state-of-the-art technology. This is the responsibility of the plant operator.

The following are key issues for effective industrial security concepts:

- Prevention of unauthorised access to plants, systems, equipment and networks
- Systems, equipment and components should only be connected to the company intranet or the internet if and when required
- Employ protective measures such as firewalls and network segmentation
- Only use the latest software product versions
- Carry out software updates as soon as new updates are available
- Use standard user accounts for regular operation
- Use secure passwords
- Appropriate safeguarding of administrator accounts
- Application of security guidelines
- Other measures to be taken as required

R. STAHL uses Windows 10 for its products. It does not develop any cryptographic functions.

R. STAHL does not configure / harden the operating system, nor does it provide or refer to security guidelines for doing so.

Furthermore, R. STAHL is constantly working on enhancing its products, thereby contributing to plant security and to minimizing the risk of cyber threats.

4 Function and device design

4.1 Features and versions

4.1.1 Options

The SERIES xx8 - SHARK device platform HMIs are Operator Stations designed for applications in the oil and gas industry and in harsh ambient conditions.

Depending on their technology, they perform the following tasks:

Technology	Task
Panel PC - SERIES 400	Industrial PC with computer and monitor
Thin Client - SERIES 500	Remote control of PCs or virtual workstations, for example via Ethernet and WLAN.
KVM System - SERIES 600	Extension of the keyboard, video and mouse interfaces of a workstation from the safe area to the hazardous industrial area.

4.1.2 Display

The SHARK device platform is available with the following types of display:

- Size: 15" or 21.5"
- Design: "VESA 200 Standard" or "VESA 200 Top Connect"
- Multi-touch function
- Dimmable (for SERIES 400 / 500 via the operating system, for SERIES 600 via keys F7 and F8)

4.1.3 Outdoor Installation

The SERIES xx8 operating devices can be operated in temperatures ranging from -10 °C to +65 °C (outdoor option O0 - standard). For outdoor option O4, the devices will be fitted with an integrated heater, allowing operating temperatures ranging from -40 °C to +65 °C.

4.1.4 Card reader for access control

As an option, the ET-/MT-x98 operating stations can be fitted with an integrated card reader. This card reader is a proximity reader that can read the corresponding transponder media without direct contact and transfer the data to operating devices or any other systems.

Two versions of RFID reader are available for different types of data transfer between reader and a corresponding software.

- CRYPT - version C5: data is transferred via an encrypted bidirectional protocol. This protocol can also be used to describe the transponder media. The connected device must be able to support the data encryption via a suitable application. The protocol description can be provided once a confidentiality agreement has been signed.
- ASCII - version C6: when the transponder medium approaches the reader or is removed from it, the reader actively sends the pre-parameterised content of the medium in the form of characters transformed byte-wise from hex code to ASCII. Applications such as PM Logon from Siemens or LogOnPlus from i.p.a.s. support this protocol.

4.1.5 Other features

- Reader interface
- Optional features:
 - WLAN and Bluetooth
 - Integrated front camera

 These features depend on the technology (see chapter [17.1 Technical data](#)).

4.1.6 Accessories

Peripherals:

- Barcode scanner
- Attached keyboard and pointing device (trackball, joystick or touchpad (Ex ia))
- Desktop keyboard with 105 keys (Ex ia) and optical desktop mouse (Ex ia)
- On / off switch

Terminal boxes are used for connections (see chapter [4.4 Terminal boxes](#)).

 For associated operating instructions see r-stahl.com.

4.2 Device design

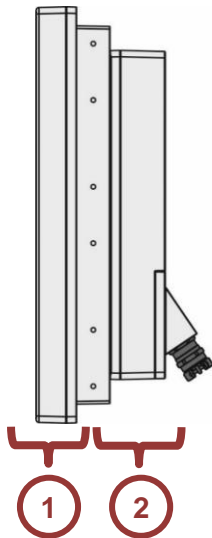

Item	Designation
1	Display module
2	E-box module

4.3 Type code

4.3.1 Fieldsystem type key code

4.3.1.1 SERIES 400 / 500

Field systems					
Definition Field systems	<p>A field system consists of at least one HMI unit and its integrated software. If the HMI unit is mounted inside an enclosure, this enclosure as well as all other accessories mounted inside it are part of the field system. To facilitate the order-process for a field system, a product code was developed that can reproduce all possible combinations of device, software, enclosure and accessories. This product code consists of alpha-numerical characters and may look as follows: ET-498-2TX-931C30000W-B3010000000 This example is valid for a Panel PC system; all other field systems (Thin Client and KVM) have product codes built in the same way.</p>				
Decoding	It is decoded as follows:				
	ET-498-2TX	-	931C30000W	-	B3010000000
Meaning	Device version	Hyphen	Extended device version	Hyphen	Enclosure and accessories
	For an exact definition of each individual character please refer to the type code for field systems on the following pages.				
	<p>A field system can only be ordered with a valid and plausible product code. For this, all digits of the product code must be filled with a valid character. Please also note that for technical reasons not all theoretically possible product codes and thus field systems can actually be realised. Should you have any questions in this regard, please contact R. STAHL HMI Systems GmbH.</p>				

Position in type key	Meaning	Possible value	Description
1, 2	Application range (zone)	ET	Devices for Zone 1, Zone 21, EPL Gb, Db
		MT	Devices for Zone 2, Zone 22, EPL Gc, Dc
3	Hyphen	-	Hyphen
4	Technology	4	Panel PC SERIES 400
		5	Thin Client SERIES 500
5	Display size	3	38 cm / 15" display, 1024 x 768 pixel
		9	55 cm / 21.5" display, 1920 x 1080 pixel
6	Family	8	fixed to 8
7	Hyphen	-	Hyphen
8, 9, 10	Ethernet	1TX	1x 1000Base-TX copper Ethernet (discontinued)
		2TX	2x 1000Base-TX copper Ethernet
		2FX	2x 100Base-FX FO Ethernet
11	Hyphen	-	Hyphen
12	Prozessor type	2	AMD GX
		3	Intel® Core™ i7 (discontinued)
		8	Intel® Core™ i7 with TPM (discontinued)
		9	Intel® Core™ i5 with TPM
13	RAM	3	4 GB main memory
		4	8 GB main memory (only i7)
		5	16 GB main memory (only i5)

14	Display type	0	Standard TFT (only 15")
		1	Sunlight Readable Display 15"
		1	Sunlight Readable Display 21.5"
15	Data memory	5	60 GB (AMD)
		9	128 GB (AMD)
		C	240 GB (i5 / i7)
		E	480 GB (i5 / i7)
16	Touch screen	0	No touch (no longer available)
		3	Capacitive multi-touch screen (glass) 15"
		3	Capacitive multi-touch screen (glass) 21.5"
17	Power supply	0	24 VDC
		1	100 – 240 VAC
18	Optional interface 1	0	No WLAN, no Bluetooth, no RFID
		1	WLAN 2.4 GHz, no Bluetooth, no RFID
		2	WLAN 2.4 GHz and 5 GHz, no Bluetooth, no RFID
		3	No WLAN, Bluetooth, no RFID
		4	WLAN 2.4 GHz, Bluetooth, no RFID
		5	WLAN 2.4 GHz and 5 GHz, Bluetooth, no RFID
		6	No WLAN, no Bluetooth, RFID C1 *
		7	WLAN 2.4 GHz, no Bluetooth, RFID C1 *
		8	WLAN 2.4 GHz and 5 GHz, no Bluetooth, RFID C1 *
		9	No WLAN, Bluetooth, RFID C1 *
		A	WLAN 2.4 GHz, Bluetooth, RFID C1 *
		B	WLAN 2.4 GHz and 5 GHz, Bluetooth, RFID C1 *
		C	No WLAN, no Bluetooth, RFID C5 *
		D	WLAN 2.4 GHz, no Bluetooth, RFID C5 *
		E	WLAN 2.4 GHz and 5 GHz, no Bluetooth, RFID C5 *
		F	No WLAN, Bluetooth, RFID C5 *
		G	WLAN 2.4 GHz, Bluetooth, RFID C5 *
		H	WLAN 2.4 GHz and 5 GHz, Bluetooth, RFID C5 *
		I	No WLAN, no Bluetooth, RFID C6 *
		J	WLAN 2.4 GHz, no Bluetooth, RFID C6 *
K	WLAN 2.4 GHz and 5 GHz, no Bluetooth, RFID C6 *		
L	No WLAN, Bluetooth, RFID C6 *		
M	WLAN 2.4 GHz, Bluetooth, RFID C6 *		
N	WLAN 2.4 GHz and 5 GHz, Bluetooth, RFID C6 *		
O	USB WLAN 2.4 GHz and 5 GHz, two antennas, Bluetooth, no RFID		

		P	USB WLAN 2.4 GHz and 5 GHz, two antennas, Bluetooth, RFID C5 *
		Q	USB WLAN 2.4 GHz and 5 GHz, two antennas, Bluetooth, RFID C6 *
		R	USB WLAN 2.4 GHz and 5 GHz, one antenna, Bluetooth, no RFID
		S	USB WLAN 2.4 GHz and 5 GHz, one antenna, Bluetooth, RFID C5 *
		T	USB WLAN 2.4 GHz and 5 GHz, one antenna, Bluetooth, RFID C6 *
Note: * internal RFID reader not for x38 devices All device options marked in red will no longer be available from 2023 !			
19	Optional interface 2 / Reader	0	No optional interface 2
		3	CAN-Bus interface (open CAN) (no longer available)
20	Optional interface 3 / Option Box	0	No optional interface 3
		1	Internal On- / Off switch
21	Enclosure design	0	Exicom VESA 200
		2	Exicom VESA 200 with ST plugs
		3	Exicom VESA 200 no camera
		5	Exicom VESA 200 Top Connect
		6	Exicom VESA 200 Top Connect with ST plugs
		7	Exicom VESA 200 Top Connect no camera
22	Operating system / Image	0	No operating system (only for AMD)
		3	Windows 7 Ultimate (no longer available)
		4	Windows Embedded Standard 7 (no longer available)
		M	WIN10 IoT & Remote Firmware V5 (no longer available)
		R	WIN10 IoT Enterprise 2016 LTSC
		S	IGEL OS 11
		T	PXE-BOOT option
		V	WIN10 IoT 2019 LTSC & Remote Firmware V6 Basic
		W	WIN10 IoT 2019 LTSC
23	Hyphen	-	Hyphen
24	Enclosure type	B	Rugged Panel design (RP)
25	Material	3	Seawater-resistant powder coated aluminum
26	Mounting option	0	VESA 200 mounting
		2	VESA 200 and Feet Set (1 pair of feet - required for wall mounting)
		3	VESA 200 Handle Feet Set (handle and feet - not for yoke and wall mounting)

27	Outdoor design	1	-10 °C
		5	-40 °C
28	Keyboard (Design, Layout) / keyboard enclosure	0	No keyboard
29	Integrated pointing device	0	No integrated pointing device
30	Separate pointing device	0	No separate pointing device
31	Separate reader device	0	No separate reader device
32	Emergency stop switch	0	No emergency stop switch
33	Separate power supply	0	No separate power supply
34	Further options 1	0	No further options 1
35	Further options 2	0	No further options 2

4.3.1.2 SERIES 600

Field systems					
Definition Field systems	<p>A field system consists of at least one HMI unit and its integrated software. If the HMI unit is mounted inside an enclosure, this enclosure as well as all other accessories mounted inside it are part of the field system. To facilitate the order-process for a field system, a product code was developed that can reproduce all possible combinations of device, software, enclosure and accessories. This product code consists of alpha-numerical characters and may look as follows: ET-698-DVI3-1TX-00103000030-B3010000000 This example is valid for a Panel PC system; all other field systems (Thin Client and KVM) have product codes built in the same way.</p>				
Decoding	It is decoded as follows:				
Meaning	ET-698-DVI3-1TX	-	00103000030	-	B3010000000
	Device version	Hyphen	Extended device version	Hyphen	Enclosure and accessories
	For an exact definition of each individual character please refer to the type code for field systems on the following pages.				
	<p>A field system can only be ordered with a valid and plausible product code. For this, all digits of the product code must be filled with a valid character. Please also note that for technical reasons not all theoretically possible product codes and thus field systems can actually be realised. Should you have any questions in this regard, please contact R. STAHL HMI Systems GmbH.</p>				

Position in type key	Meaning	Possible value	Description
1, 2	Application range (zone)	ET	Devices for Zone 1, Zone 21, EPL Gb, Db
		MT	Devices for Zone 2, Zone 22, EPL Gc, Dc
3	Hyphen	-	Hyphen
4	Technology	6	KVM System SERIES 600
5	Display size	3	38 cm / 15" display, 1024 x 768 pixel
		9	55 cm / 21.5" display, 1920 x 1080 pixel
6	Family	8	fixed to 8

7	Hyphen	-	Hyphen
8, 9, 10, 11	Transfer technology	DVI3	DVI3 KVM technology
12	Hyphen	-	Hyphen
13, 14, 15	Ethernet	1TX	1x 100/1000Base-TX copper Ethernet
		1SX	1x 1000Base-SX FO Ethernet, multi-mode
		1LX	1x 1000Base-LX FO Ethernet, single mode
16	Hyphen	-	Hyphen
17	Processor type	0	Non-existent
18	RAM	0	Non-existent
19	Display type	0	Standard TFT (only 15")
		1	Sunlight Readable Display 15"
		1	Sunlight Readable Display 21.5"
20	Data memory	0	Non-existent
21	Touch screen	0	No touch (no longer available)
		3	Capacitive multi-touch screen (glass) 15"
		3	Capacitive multi-touch screen (glass) 21.5"
22	Power supply	0	24 VDC
		1	100 – 240 VAC
23	Optional interface 1	0	No Bluetooth, no RFID
		3	Bluetooth, no RFID
		C	No Bluetooth, RFID C5 *
		F	Bluetooth, RFID C5 *
		I	No Bluetooth, RFID C6 *
		L	Bluetooth, RFID C6 *
Note: * internal RFID reader not for 638 devices All device options marked in red will no longer be available from 2023 !			
24	Optional interface 2 / Reader	0	No optional interface 2
25	Optional interface 3 / Option Box	0	No optional interface 3
26	Enclosure design	0	Exicom VESA 200
		2	Exicom VESA 200 with ST plugs
		3	Exicom VESA 200 no camera
		5	Exicom VESA 200 Top Connect
		6	Exicom VESA 200 Top Connect with ST plugs
		7	Exicom VESA 200 Top Connect no camera
22	Operating system / Image	0	Non-existent
23	Hyphen	-	Hyphen
24	Enclosure type	B	Rugged Panel design (RP)
25	Material	3	Seawater-resistant powder coated aluminum

26	Mounting option	0	VESA 200 mounting
		2	VESA 200 and Feet Set (1 pair of feet - required for wall mounting)
		3	VESA 200 Handle Feet Set (handle and feet - not for yoke and wall mounting)
27	Outdoor design	1	-10 °C
		5	-40 °C
28	Keyboard (Design, Layout) / keyboard enclosure	0	No keyboard
29	Integrated pointing device	0	No integrated pointing device
30	Separate pointing device	0	No separate pointing device
31	Separate reader device	0	No separate reader device
32	Emergency stop switch	0	No emergency stop switch
33	Separate power supply	0	No separate power supply
34	Further options 1	0	No further options 1
35	Further options 2	0	No further options 2

4.3.2 Display module type key code

Not all combinations of the type key codes of display and E-box module are technically possible. This section does not list the limits, however. All versions available for sale are contained in the price lists and the configurators. Should you have any questions, please contact R. STAHL HMI Systems GmbH.

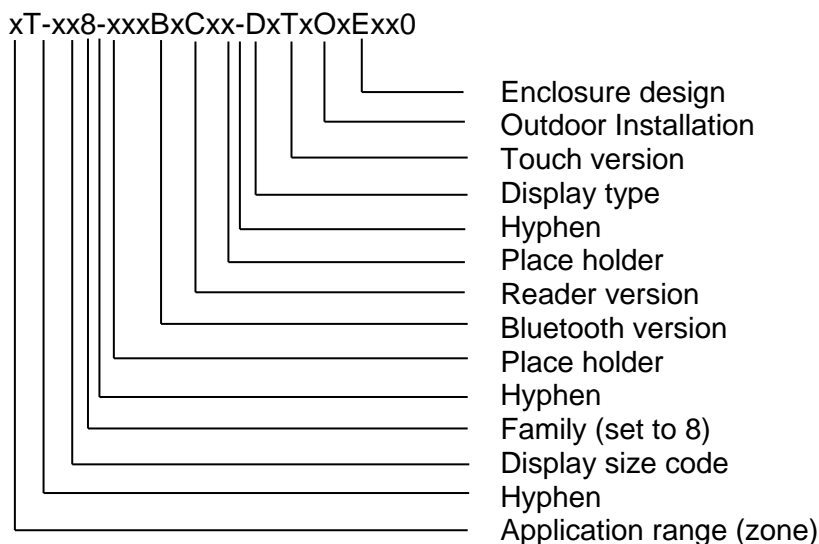

Position in type key	Possible value	Description
xT	ET	Devices for Zone 1, Zone 21, EPL Gb, Db
	MT	Devices for Zone 2, Zone 22, EPL Gc, Dc
-	-	Hyphen
xx	x3	15" display
	x8	24" WU display (not realised)
	x9	21.5" display
8	8	Generation 8
-	-	Hyphen
xxx	xxx	Place holder
Bx	B0	No Bluetooth
	B1	Integrated Bluetooth
Cx	C0	No integrated reader interface
	C1	Integrated RFID 13.56 MHz reader interface (no longer available)
	C2	Integrated RFID 2.4 GHz reader interface (not realised)
	C3	Integrated RFID 13.56 MHz reader interface MIFARE / DESFire / EV1, CRYPT (not realised)
	C4	Integrated reader interface RFID 13.56 MHz, MIFARE / DESFire / EV1, ASCII (not realised)
	C5	Integrated reader interface RFID 13.56 MHz, LEGIC, MIFARE / DESFire / EV1, CRYPT
	C6	Integrated reader interface RFID 13.56 MHz, LEGIC, MIFARE / DESFire / EV1, ASCII
	C7	Integrated reader interface RFID 13.56 MHz, NFC (not realised)
x	x	Place holder
-	-	Hyphen
Dx	D0	Display type TFT
	D1	Display type "sunlight readable"
Tx	T0	No touch screen (no longer available)
	T3	Capacitive multi-touchscreen (glass)
Ox	O0	Outdoor installation -10 °C
	O4	Outdoor installation -40 °C
Exx0	E000	Enclosure design Exicom VESA 200
	E010	Enclosure design Exicom VESA 200 without camera
	E100	Enclosure design Exicom VESA 200 Top Connect
	E110	Enclosure design Exicom VESA 200 Top Connect without camera

4.3.3 E-Box module SERIES 400 / 500 type key code

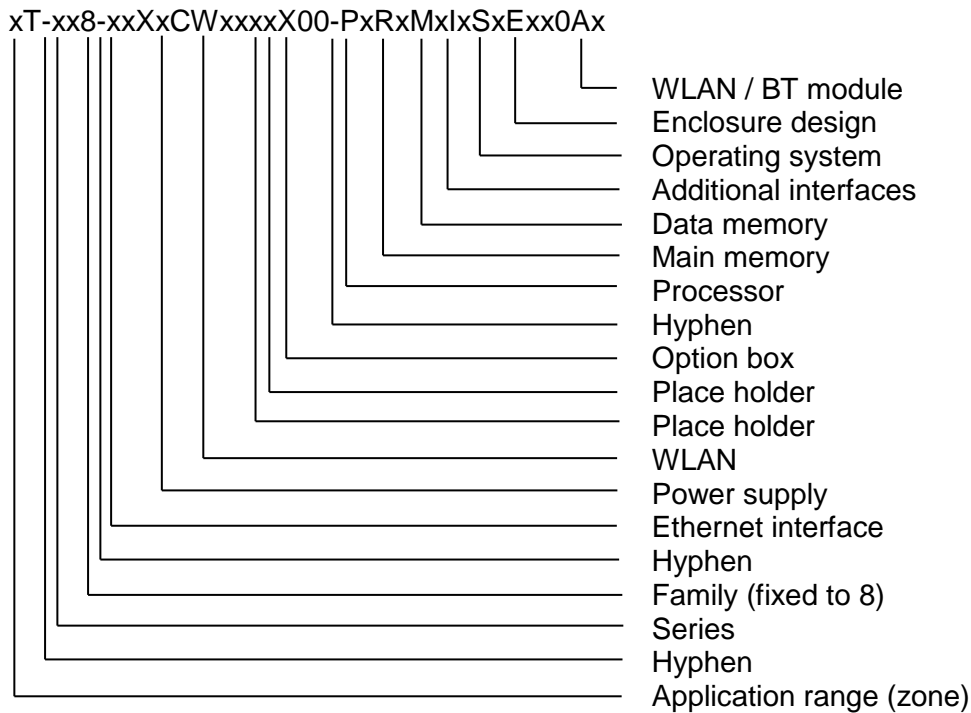

Position in type key	Possible value	Description
xT	ET	Devices for Zone 1, Zone 21, EPL Gb, Db
	MT	Devices for Zone 2, Zone 22, EPL Gc, Dc
-	-	Hyphen
xx	4x	E-box SERIES 400
	5x	E-box SERIES 500
8	8	Generation 8
-	-	Hyphen
xxx	xxx	Place holder
xxX	1TX	1x 1000Base-TX copper Ethernet (no longer available)
	2TX	2x 1000Base-TX copper Ethernet
	2FX	2x 100Base-FX FO Ethernet
xC	AC	AC power supply 100 - 240 VAC
	DC	DC power supply 24 VDC
Wxx	W00	No WLAN interface
	W02	WLAN interface RF 2.4 GHz
	W05	WLAN interface RF 5 GHz
	W22	WLAN interface 2x RF 2.4 GHz
	W55	WLAN interface 2x RF 5 GHz
	W25	WLAN interface RF 2.4 GHz and RF 5 GHz
x	x	Place holder
x	x	Place holder
X00	X00	No option box
-	-	Hyphen

Px	P0	Processor provision
	P2	AMD processor
	P3	Intel i7 processor (discontinued)
	P4	Intel i7 processor with TPM (discontinued)
	P5	Intel i5 processor with TPM
Rx	R3	4 GB main memory
	R4	8 GB main memory (only i7)
	R5	16 GB main memory (only i5)
Mx	M5	60 GB memory
	M6	80 GB memory (no longer available)
	M9	128 GB memory
	MB	160 GB memory (no longer available)
	MC	240 GB memory
	MD	300 GB memory (no longer available)
	ME	480 GB memory
Ix	I0	No optional interface
	I4	CAN-Bus interface (open CAN) (no longer available)
Sx	S0	No operating system
	S3	Windows 7 Ultimate (no longer available)
	S4	Windows Embedded Standard 7 (no longer available)
	S5	Windows 10 IoT Enterprise 2016 LTSB
	S8	Windows 10 IoT Enterprise 2016 LTSC with Remote software V5 (no longer available)
	S9	Windows 10 IoT Enterprise 2019 LTSC at SERIES 500 with Remote software V6
Exx0	E000	Enclosure design Exicom VESA 200
	E020	Enclosure design Exicom VESA 200 with ST plugs
	E100	Enclosure design Exicom VESA 200 Top Connect
	E120	Enclosure design Exicom VESA 200 Top Connect with ST plugs
Ax	A0	No WLAN, no antenna
	A1	WLAN / BT module 2.4 GHz and 5 GHz, one antenna
	A2	WLAN / BT module 2.4 GHz and 5 GHz, two antennas

4.3.4 E-box module SERIES 600 type key code

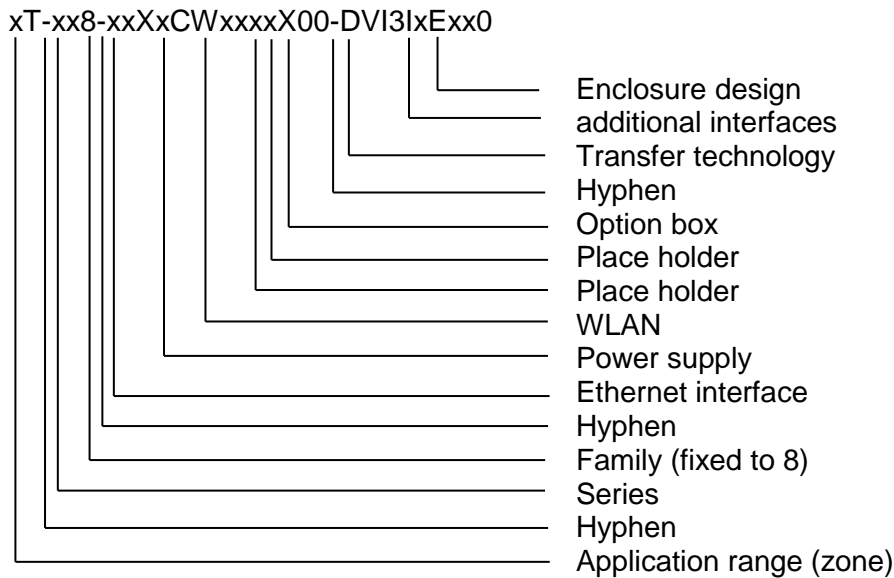

Position in type key	Possible value	Description
xT	ET	Devices for Zone 1, Zone 21, EPL Gb, Db
	MT	Devices for Zone 2, Zone 22, EPL Gc, Dc
-	-	Hyphen
xx	6x	E-box SERIES 600
8	8	Generation 8
-	-	Hyphen
xxX	1TX	1x 100/1000Base-TX copper Ethernet
	1SX	1x 1000Base-SX FO Ethernet, multi-mode
	1LX	1x 1000Base-LX FO Ethernet, single mode
xC	AC	AC power supply 100 - 240 VAC
	DC	DC power supply 24 VDC
Wxx	W00	No WLAN interface
x	x	Place holder
x	x	Place holder
X00	X00	No option box
-	-	Hyphen
DVI3	DVI3	DVI3 KVM Technology
Ix	I0	No optional interface
Exx0	E000	Enclosure design Exicom VESA 200
	E020	Enclosure design Exicom VESA 200 with ST plugs
	E100	Enclosure design Exicom VESA 200 Top Connect
	E120	Enclosure design Exicom VESA 200 Top Connect with ST plugs

4.4 Dimensions

4.4.1 Front:

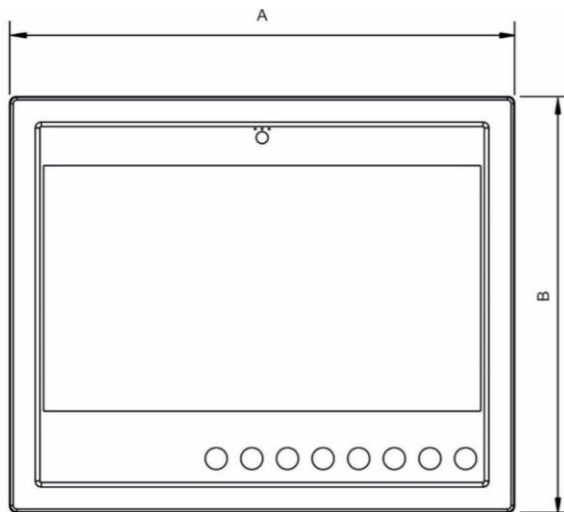

Dimensions [mm]		
Item	ET-x38 / MT-x38	ET-x98 / MT-x98
A	380	553
B	394	458

4.4.2 Page - VESA 200 Standard

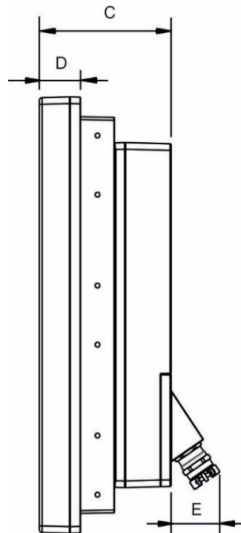

Dimensions [mm]		
Item	ET-x38 / MT-x38	ET-x98 / MT-x98
C	137	141
D	40	44
E	52	52

4.4.3 Page - VESA 200 Top Connect

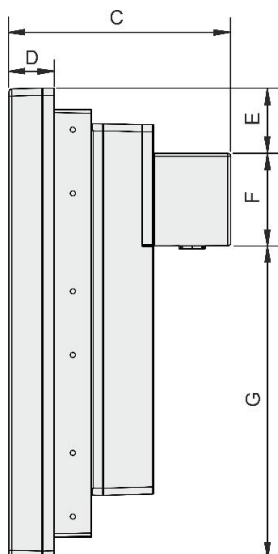

Dimensions [mm]		
Item	ET-x38 / MT-x38	ET-x98 / MT-x98
C	212	216
D	40	44
E	46	64
F	90	90
G	257	304

4.5 Terminal boxes

4.5.1 VESA 200 Standard

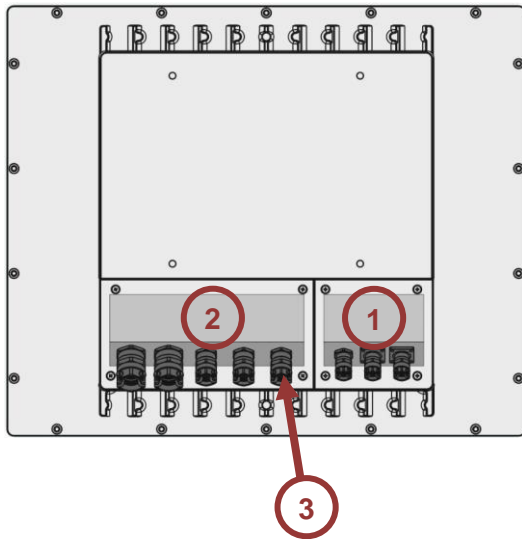

Item	Designation
1	Cover of Ex i terminal box
2	Cover of Ex e terminal box
3	Cable glands



Cable glands (number, size) see ET-/MT-xx8 Installation Manual (IM_ET_MT-xx8)

4.5.2 VESA 200 Top Connect

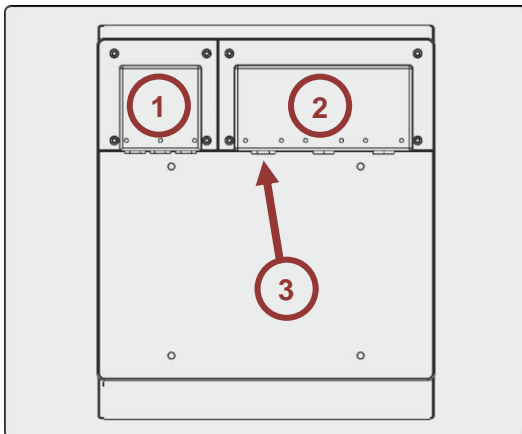

Item	Designation
1	Cover of Ex i terminal box
2	Cover of Ex e terminal box
3	Screw plugs



Screw plugs (number, size) see ET-/MT-xx8 Installation Manual (IM_ET_MT-xx8)

4.6 Operating elements

4.6.1 ET-/MT-x38 (15")



Item	Designation
1	LEDs and front camera (optional)
2	Display
3	Function keys F1 to F8

4.6.2 ET-/MT-x98 (21.5")

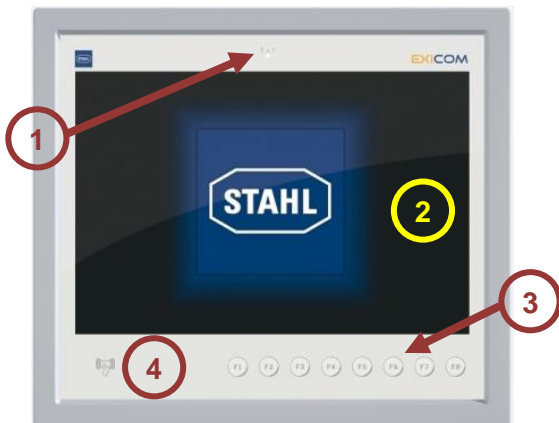

Item	Designation
1	LEDs and front camera (optional)
2	Display
3	Function keys F1 to F8
4	RFID card reader (optional)

4.7 LED status display

Pictogram	LED colour	Status	Meaning
	Blue	lit	For "outdoor installation" version: internal heater is switched on. The device is being heated up.
	Orange	lit	Device is live. Internal power supply ok.
	Green	lit	Internal temperature has reached the required operating temperature level. The device is ready.

4.8 Markings on the device

4.8.1 Position

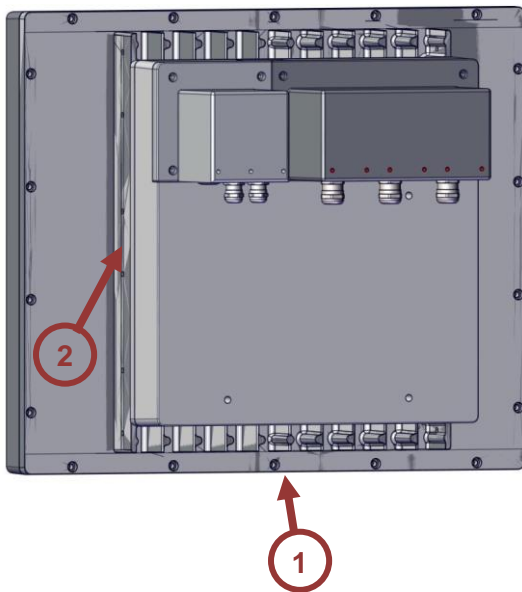

Item	Designation
1	Display type and approval label
2	Field system type label

4.8.2 Design of a type label (taking the field system type label as an example)



Item	Designation
1	Type key code (see chapters 4.3.2 to 4.3.4)
2	Article number of hardware
3	QR code
4	Manufacturing date (calendar week.YY)
5	Serial number
6	Address of manufacturer

4.9 Approval label

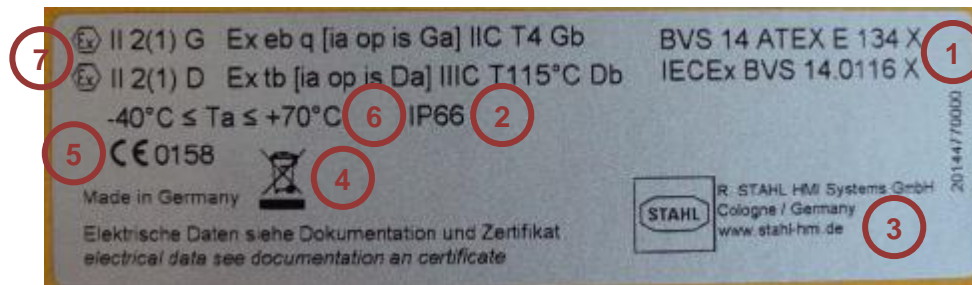

Item	Designation
1	Certificate numbers
2	Degree of protection
3	Address of manufacturer
4	Marking according to WEEE directive 2012/19/EU
5	CE number
6	Approved ambient temperature
7	Ex classification ATEX / IECEx

4.9.1 Ex classification ATEX / IECEx

Ex marking ATEX / IECEx according to IEC 60079-0 and ATEX directive 2014/34/EU.

ET-xx8 HMI series

Version	2014/34/EU prefix	Ex marking
Gas	Ex II 2(1) G	Ex eb q [ia op is Ga] IIC T4 Gb
Dust	Ex II 2(1) D	Ex tb [ia op is Da] IIIC T115°C Db

MT-xx8 HMI series

Version	2014/34/EU prefix	Ex marking
Gas	Ex II 3(1) G	Ex ec nR [ia op is Ga] IIC T4 Gc
Dust	Ex II 3(1) D	Ex tc [ia op is Da] IIIC T115°C Dc

4.9.2 Ex classification FM USA

US-American Ex classification according to ANSI/UL 60079-0.

ET-xx8 HMI series

Version	Ex marking
Gas	Class I, Zone 1 AEx eb q [ia op is Ga] IIC T4 Gb
	Class I, Div. 2 Groups A, B, C, D T4
Dust	Zone 21, AEx tb [ia op is Da] IIIC T115°C Db
	Class II, Div. 2 Groups F, G T4
	Class III

MT-xx8 HMI series

Version	Ex marking
Gas	Class I, Zone 2 AEx nA nR [ia op is Ga] IIC T4 Gc
	Class I, Div. 2 Groups A, B, C, D T4
Dust	Zone 22, AEx tc [ia op is Da] IIIC T115°C Dc
	Class II, Div. 2 Groups F, G T4
	Class III

4.9.3 Ex classification FM Canada

Canadian Ex classification according to CAN/CSA-C22.2 No.60079-0.

ET-xx8 HMI series

Version	Ex marking
Gas	Ex eb q [ia Ga] IIC T4 Gb
	Class I, Div. 2 Groups A, B, C, D T4
Dust	Zone 21, Ex tb [ia Da] IIIC T115°C Db
	Class II, Div. 1 Groups E, F, G T4
	Class III

MT-xx8 HMI series

Version	Ex marking
Gas	Ex nA nR [ia Ga] IIC T4 Gc
	Class I, Div. 2 Groups A, B, C, D, T4
Dust	Zone 22, Ex tc [ia Da] IIIC T115°C Dc
	Class II, Div. 2 Groups E, F, G T4
	Class III

4.9.4 Ex classification CCC China

Chinese CCC classification according to GB3836.x.

ET-xx8 HMI series

Version	Ex marking
Gas	Ex eb q [ia op is Ga] IIC T4 Gb
Dust	Ex tb [ia op is Da] IIIC T115°C Db

MT-xx8 HMI series

Version	Ex marking
Gas	Ex ec nR [ia op is Ga] IIC T4 Gc
Dust	Ex tc [ia op is Da] IIIC T115°C Dc

4.9.5 Ex classification CNEEx China

Chinese Ex classification according to GB3836.x.

ET-xx8 HMI series

Version	Ex marking
Gas	Ex eb q [ia op is Ga] IIC T4 Gb
Dust	Ex tb [ia op is Da] IIIC T115°C Db

MT-xx8 HMI series

Version	Ex marking
Gas	Ex ec nR [ia op is Ga] IIC T4 Gc
Dust	Ex tc [ia op is Da] IIIC T115°C Dc

4.9.6 Ex classification PESO

PESO classification according to IECEx

ET-xx8 HMI series

Version	Ex marking
Gas	Ex eb q [ia op is Ga] IIC T4 Gb

MT-xx8 HMI series

Version	Ex marking
Gas	Ex ec nR [ia op is Ga] IIC T4 Gc

4.9.7 Ex classification KCS

Model version ET-xx8

Version	Ex marking
Gas	Ex eb q [ia op is Ga] IIC T4 Gb
Dust	Ex tb [ia op is Da] IIIC T115°C Db

Model version MT-xx8

Version	Ex marking
Gas	Ex ec nR [ia op is Ga] IIC T4 Gc
Dust	Ex tc [ia op is Da] IIIC T115°C Dc

5 Operating systems and drivers

5.1 Up to Windows 7

5.1.1 Licensing issues

Panel PC - SERIES 400

The Windows operating system is usually pre-installed. Please note that under the terms of the license issued for Windows the application of these systems as office PCs is not permitted.



Please also note the information on the licensing terms for Windows operating systems contained in the "TechNote Windows Operating Systems" file located on the CD / DVD / USB stick which is part of the delivery, or online under r-stahl.com.

5.2 Windows® 10 IoT Enterprise 2019 LTSC operating system

The operating system is based on Windows 10 for PC platforms with 64 bit x86 processors. For the LTSC (Long Term Servicing Channel) versions, Microsoft guarantees 10 years of security updates and new builds with feature updates only every 2-3 years, with these being optional. The LTSC versions are ideal for industrial applications and feature additional security components such as write filters (UWF) and HORM (start of a system snapshot from the RAM plus write protection).

From 2016 LTSB onwards, Microsoft has tied its licensing model to the processor performance:

ENTRY for AMD® GX and ATOM™

VALUE for Intel® Core i5™

HIGH for Intel® Core i7™

Panel PC - SERIES 400

The license for the Windows 10 IoT Enterprise 2019 LTSC operating system is included in the image. When delivered, the devices have already been registered and activated.

The EOL (End of Life) date for Windows 10 IoT Enterprise 2019 LTSC for support and updates has been set by Microsoft to 2029-01-09.

5.2.1 Recovery



If a Panel PC is reset to the factory state (recovered) it will remain registered but will have to be reactivated. This requires an active internet connection to a Microsoft server.

5.2.2 Proprietary Windows installations and drivers



The Windows 10 IoT license key is tied to STAHL images. The installation of own Windows 10 IoT operating systems requires a separate license key. All necessary drivers are provided by R. STAHL HMI Systems GmbH. Please contact our Support department.

5.3 Data back-up

5.3.1 Recovery Stick



A recovery stick is required to restore the Panel PC devices to their factory state. This recovery stick (USB drive, also available as an intrinsically safe option) contains the factory image, with which the system can be restored to factory state within a very short time.

You can restore the HMI devices to their factory state only with the aid of this recovery stick. As an option, the recovery stick can also contain a backup software, with which you can back up your own device configuration.

5.3.2 Back-up

It is the sole responsibility of the operator to generate a back-up of the HMI devices and their overall function !

- Any back-ups generated of the HMI devices must always be stored on external storage media !

5.3.3 Switching off / closing down



The Microsoft Windows operating system stores key data in the main memory, regardless of the application, and has to store this data on the hard disk before the HMI device is switched off. It is therefore important for the safe and correct operation that the HMI device is "shut down" properly (see illustration below) and **NOT** simply switched off.

Otherwise the existing image of the HMI device may be damaged, rendering the device non-functioning. After the data has been stored, Windows informs the user that the HMI device can now be switched off.

- Only switch off the HMI device when prompted to do so by a system message !

5.3.4 Loss of data

- In the case of applications that require constant writing into memory, use external storage media (USB sticks, network servers) for these write processes !
- Avoid cyclical writes (log files, databases, etc.) to the SSD !

The endurance of an SSD depends on the number of write cycles (TBW / terabytes written). Writing to the SSD with a simultaneous drop in voltage is most likely going to result in data loss.

5.4 License sticker

The license sticker for the Windows 7 Ultimate operating system is located inside the E-box terminal box.



The license sticker for the Windows Embedded and Windows 10 IoT operating systems is located on the outside of the device on the type label.

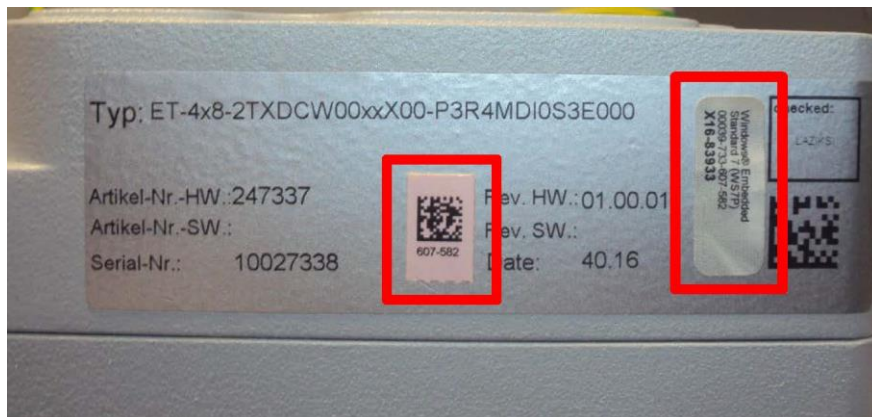

5.5 UPDD touch driver

The UPDD touch driver is a copyrighted, licensed software for the exclusive use with R. STAHL HMI Systems GmbH touch systems.

- Do not load this driver on or use with other devices !

6 Transport and storage

NOTE	<p>No or damaged packaging during transport and storage</p> <p>If the device is transported or stored without packaging, shocks, vibrations, pressure and humidity can directly impact the device. Damaged packaging indicates that the device has been subjected to and possibly been damaged by outside influences. This may result in faulty functionality.</p> <ul style="list-style-type: none">• Check the state of the packaging.• Report any damage sustained in transport to the haulier responsible and have it confirmed.• Transport and store the device in undamaged packaging, ideally the original packaging.
-------------	---

- Transport and store the device carefully and in accordance with the safety notes (see chapter [3 Safety](#)).
- Transport and store the device in undamaged packaging, ideally the original packaging.
- Ensure specified storage temperature range is not exceeded (see chapter [17.1.4 Ambient conditions](#)).
- Store the device in a dry place free of vibrations.
- Do not drop the device.

7 Unpacking

- Unpack the device at its final destination.
- Check the contents are complete and undamaged.
- Contact the manufacturer if the contents are incomplete, damaged or not what you have ordered.
- Dispose of the packaging materials according to local regulations.

8 Mounting and installation

8.1 Note on mounting and installation

Observing the following points will ensure a professional and safe assembly and installation:

- Only use threads or holes already present in the enclosure or the outer cooling fins of the display modules.
- Mount the device carefully and strictly in accordance with the safety notes (see chapter [3 Safety](#)).
- Study the installation conditions and assembly instructions in these operating instructions carefully and follow them to the letter.

8.2 Requirements for site of installation



Mount and install the device in such a way that it is always operated within the permissible temperature range.

- Observe the stipulated hazardous zones: MT devices may only be installed in Zone 2 and Zone 22.
- The site of installation must be stable and suitable for the dimensions of the device, and able to bear the load of its weight and that of any necessary attachments.
- Avoid touch screen contamination by saltwater: conductive liquids on the touch display can result in incorrect or phantom operations. This applies in particular to salt water.
- Protect the device against rain, snow and splashes: excessive amounts of standing or running water will disrupt operation and may cause erratic cursor movement. This protection can be achieved by using a canopy or some other protective roof-type construction. Offshore, strong winds, saltwater and rain will have to also be taken into consideration.

8.3 Mounting types

The device may be installed and operated in any position. R. STAHL recommends the following types of mounting:

Yoke and wall-mounting, handle and feet, sun protection roof, panel mount (with xx8 Mounting-Kit)



For a detailed description of the types of mounting refer to the Installation Manual stored on the CD / DVD / USB stick included in the delivery or online at r-stahl.com.

8.4 Panel mount with xx8 Mounting-Kit

The SHARK device platform can be mounted inside an enclosure with a suitable cut-out with the aid of an xx8 fixing frame set (mounting kit). This mounting kit is approved for installation in Ex e, Ex p or Ex tb enclosures.

With correct assembly according to the instructions "IM_Mounting-Kit_xx8", the IP protection of the enclosure is retained up to a maximum of IP66.

The xx8 mounting kit consists of sealing material and a fixing frame. The sealing material is applied to the back of the xx8 device. The fixing frame is used to fix the device inside the cover cut-out of the enclosure. It is mounted from the back.

For a detailed description of the panel mount with xx8 Mounting-Kit see chapter [23.1 Panel mount with xx8 Mounting-Kit](#).

Tightening torque	
Fixing frame screws	1.5 Nm to 2 Nm



	For instructions on other types of mounting, see Installation Manual "IM_ET_MT-xx8" on the CD / DVD / USB stick included in the delivery or online at r-stahl.com .
---	--

NOTE	<p>If a defective seal is found on a device that has been returned to the manufacturer, an agreement is made with the customer as to whether it should be repaired (replaced). If this exchange is not necessary, the option "No hazloc approved panel mount" is marked on the device by the manufacturer.</p> <p>The device is only approved for installation inside an Ex e, Ex p or Ex tb enclosure if no "No hazloc approved panel mount" option is indicated on the device. If the "No hazloc approved panel mount" option is indicated on the device, certification according to NEC / CEC is no longer possible or becomes void !</p>
-------------	--

8.5 Installation

 DANGER	<p>Explosion hazard due to improper installation ! Non-compliance may result in fatal or serious injuries.</p> <ul style="list-style-type: none"> • Ensure the atmosphere is non-explosive. • Make sure that the device is not damaged. • If the device is connected to the mains: <ul style="list-style-type: none"> ○ Disconnect the device from the power supply. ○ Isolate supply and all Ex e circuits and wait 5 minutes before opening the terminal boxes.
---	--

 DANGER	<p>Explosion hazard due to electrostatic charge! Non-compliance may result in fatal or serious injuries.</p> <ul style="list-style-type: none"> • Do not apply protective foil to touch display.
---	--

 WARNING 	<p>Danger of laser radiation at emitting diode (TD-A, TD-B) or at the end of the fibre optic cable. Eye injury</p> <p>The laser diodes in the Exicom operating devices, media converters and switches emit invisible laser radiation:</p> <table style="width: 100%; border: none;"> <tr> <td style="width: 60%;">100Base-FX</td> <td style="text-align: right;">- 1300 nm</td> </tr> <tr> <td>FO-MM / 1000Base-SX</td> <td style="text-align: right;">- 770 ... 860 nm</td> </tr> <tr> <td>FO-SM / 1000Base-LX</td> <td style="text-align: right;">- 1270 ... 1355 nm</td> </tr> </table> <p>According to EN 60825-1, the laser diode is assigned to the laser class 1M.</p> <ul style="list-style-type: none"> • Do not view the laser radiation directly (within a distance of 100 mm) with optical instruments (e.g. magnifiers, microscopes). 	100Base-FX	- 1300 nm	FO-MM / 1000Base-SX	- 770 ... 860 nm	FO-SM / 1000Base-LX	- 1270 ... 1355 nm
100Base-FX	- 1300 nm						
FO-MM / 1000Base-SX	- 770 ... 860 nm						
FO-SM / 1000Base-LX	- 1270 ... 1355 nm						

8.5.1 General information on electric connection

- Connect cables carefully.
- Do not screw down on the cable insulation.
- Do not switch cables.
- Observe code of practice when connecting cables.
- Firmly screw down wires.
- Pay attention to the voltage specified on the device:
 - Connect DC devices to 24 VDC only.
 - Connect AC devices to 100 to 240 VAC only.
- Pay attention to specified torques for screws to avoid damage to threads.
- Suitable measures against electrical surge during lightning strike may be necessary.

8.5.2 Connecting device to power supply

1. Open the cover of the Ex e terminal box (see chapter [4.4 Terminal boxes](#)).
2. Connect cable to terminal X1 POWER (see chapter [19.1 Connection overview terminal assignment](#)). Ensure correct polarity and power supply (AC or DC).

8.5.3 Grounding the device

- Open the cover of the Ex i terminal box (see chapter [4.4 Terminal boxes](#)).
- Ground the devices with a core cross section of at least 4 mm² or in line with applicable standards.
- Using external earth connection:

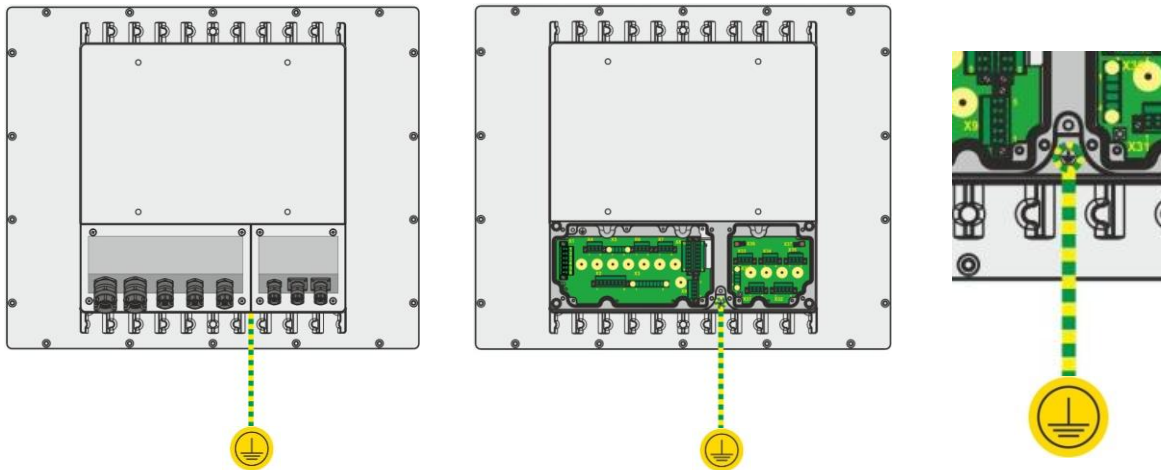

8.5.4 Connecting data cable

- Connect the data cables according to the terminal diagram (for copper connections) or connect them to the sockets (for FO connections).



For detailed instructions see Installation Manual "IM_ET_MT-xx8" on the CD / DVD / USB stick included in the delivery or online under r-stahl.com.

8.5.5 Mounting the cover of the terminal boxes

Tightening torque	
Terminal box cover screws	1 Nm to 1.5 Nm

8.5.6 Connecting associated equipment

The cover of the terminal boxes (Ex i / Ex e / Ex nA) includes mounting options for associated equipment such as cable glands, cable connectors, buttons.

The associated equipment to be mounted inside the cover of the terminal boxes must meet the following requirements:

Ingress protection:	IP66
Ex e terminal boxes:	IEC, ANSI/UL or CSA C22.2 number 60079-7
Ex i terminal boxes:	IEC, ANSI/UL or CSA C22.2 number 60079-11
Ex nA terminal boxes:	ANSI/UL or CSA C22.2 number 60079-15

- Observe the specific requirements of the associated equipment used (e.g. permitted cable diameter for cable glands, tightening torques, cable clamps).
- Observe country-specific regulations, in particular any ambient parameters that may be different (e.g. ambient temperature range).
- In the case of AC devices, IEC 60950 stipulates that an easily accessible disconnection mechanism must be located outside of the device which can be used to interrupt the power supply.

- Close unused openings with a blind plug.
- Mount cable glands with conical threads with at least three thread turns.
- Cable glands with parallel threads must have the following characteristics:
 - Tolerance class 6H or higher
 - additional seal

8.5.7 Cable glands

In their factory state, the devices are equipped with cable glands or screw plugs. They have been chosen to comply with all relevant certifications of the device. The device's ex-relevant markings also cover the bushings, which are not necessarily separately marked when included in the delivery.

- Unused cable glands must be sealed with certified screw plugs.
- Close any open enclosure holes without cable glands with a certified screw plug. Such certified screw plugs must be approved for the following areas or higher:
 - Certified zone
 - Permitted temperature range
 - Country approval (e.g. ATEX for Europe) of the device
- Alternative, similar and certified cable glands may be used provided they have an equal or higher area of certification (zone) and permitted temperature range, and the same country approval (e.g. ATEX for Europe) as the HMI device.
- Use cable glands with cap nut and without strain relief clamp for permanently installed cables and electrical lines only.
- Ensure required strain relief is in place.
- Observe recommended tightening torques. Too low or too high tightening torques might have a negative impact on the type of protection, sealing or strain relief.
- Before commissioning, check any screws that are already mounted and tighten them if necessary.

Tightening torque	
Cable glands	Depending on cables used: <ul style="list-style-type: none"> • Individually determine and apply required tightening torques.
Cable glands (installed ex-factory)	In the case of factory-supplied systems, all components are installed correctly and in accordance with applicable standards.

8.5.8 Electric connections of interfaces X1 ... X9 and X31 ... X35

Stripping length	7	mm
Mounting torque	0.5 ... 0.6	Nm

Connectable conductor cross section		
• rigid	0.2 ... 2.5 (24 ... 12)	mm ² (AWG)
• flexible	0.2 ... 2.5 (24 ... 12)	mm ² (AWG)
Multi-conductor connection (two conductors with the same cross section and conductor type)		
• rigid	0.2 ... 1.5 (24 ... 16)	mm ² (AWG)
• flexible	0.2 ... 1.0 (24 ... *1)	mm ² (AWG)
Multi-conductor connection for X1 as screw terminal (two conductors with the same cross section and conductor type):		
• rigid	0.2 ... 1.5 (24 ... 16)	mm ² (AWG)
• flexible	0.2 ... 0.75 (24 ... 18)	mm ² (AWG)

* No direct equivalent AWG size listed in IEC 60079-7.

Notes on plug and screw connectors:

- The plug connectors are designed to be readily connected or disconnected without load.
- Tighten the plug connector screws.
- Ensure that the following maximum rated current values are not exceeded:
 - The maximum rated current value for every contact of the X1 plug connector is 12 A.
 - The maximum rated current value for every contact of the X1 screw connector is 16 A.
- Values that must not be exceeded at the place of installation:
 - Voltage: max. 250 V
 - Short-circuit current: max. 1500 A
- Only use copper wires with the following characteristics for connections to the device:
 - For ambient temperatures <60 °C: copper wires approved for at least 90 °C
 - For ambient temperatures >60 °C (up to permitted maximum temperature): copper wires approved for 105 °C

	Observe and apply tightening torques recommended for connection terminals.
---	--

8.5.9 Details for electrical connection of Interface X10

- Use connector X10 with connectors / devices approved by the manufacturer only.

8.6 Using USB interfaces

Hardware and connection					
Connection to	intrinsically safe USB devices			non-intrinsically safe equipment	
	safe area	hazardous area	Device	safe area	hazardous area
X33 (Ex i)	x	x	e.g. KBDi-USB- [*] -xx8- [*] keyboard cable	–	–
X34 (Ex i)	x	x	e.g. KBDi-USB- [*] -xx8- [*] pointing device cable	–	–
X35 (Ex i)	x	x	e.g. USBi drive	–	–
X6 (Ex e)	–			any USB device	explosion-protected but non-intrinsically safe devices

Functionality and application			
ET-/MT- 4x8- [*]	Restoring factory state	USBi drive	device function
	Creation of user / OEM backup		
	Software installation		
ET-/MT- 5x8- [*]	Operation	KBDi-USB- [*] -xx8- [*] KB2- [*] -HSG- [*]	
	Restoring factory state	USBi drive	
	Import / export parameters		
ET-/MT- 6x8- [*]	Operation	KBDi-USB- [*] -xx8- [*] KB2- [*] -HSG- [*]	
	Data memory	USBi drive	
	Operation		

9 Initial start-up

Conditions:

The device has been installed correctly.

The device has been connected to the equipotential bonding.

1. Since factors such as storage or temperature can have an impact on the cables and cable glands, check the following connections:
 - Connection terminals
 - Existing screw connections
2. Switch on power supply.
 - The device will start up in its standard configuration.
3. Follow the instructions on the screen.



10 (Re-) Commissioning

1. Check the device is correctly installed:
 - Connection terminals
 - Existing screw connections
2. Check the device for visible damage.
 - Only commission the device if there is no visible damage and if it has been correctly installed.
3. Switch on power supply.
 - The device will start up with the configuration saved last.
 - If the connected systems can be reached, communication will be established within the existing parameters.

11 Operation

 DANGER	<p>Explosion hazard due to damaged device ! Non-compliance may result in fatal or serious injuries. In case of damage or changes to the factory state (for example if the device is leaking small glass beads):</p> <ul style="list-style-type: none"> • Decommission device immediately. • Contact manufacturer.
---	--

 DANGER	<p>Explosion hazard due to electrostatic charge ! Non-compliance may result in fatal or serious injuries</p> <ul style="list-style-type: none"> • Do not apply protective foil to touch display.
---	---

 WARNING 	<p>Hot surfaces ! Non-compliance may result in minor burns. In ambient temperatures exceeding +45 °C the surface of the device may heat up.</p> <ul style="list-style-type: none"> • Do not touch the device.
---	---

NOTE	<p>Display damage due to permanent display of identical pattern Non-compliance may result in screen burn-in</p> <ul style="list-style-type: none"> • Use screen savers or regularly move the screen pointer if a specific pattern is displayed permanently.
------	--

11.1 Operating the touch display

NOTE	<p>Touching the touch screen with pointed or sharp items Non-compliance may result in damage to the touch display, shorter life-span or total breakdown !</p> <ul style="list-style-type: none"> • Only operate the touchscreen with your finger or a touch pen specifically intended for capacitive touch displays.
------	---

Incorrect operation of the touch display may result in accidental functions and errors. The device will then be unable to execute orders, may execute them incorrectly or in a way not intended.

- Do not realise safety-relevant functions via the touch display.
- Avoid accidental multiple touches.
- Do not touch the touch display across a large section.
- Only use fingers, thin gloves or special gloves or a conductive touch pen for operation.
- Before operating the device, thoroughly acquaint yourself with the multi-touch functions of the operating system and the application.
- Avoid contamination of the touch display with salt water.

11.2 Switching the device on and off

11.2.1 Without optional on/off switch

The device is switched on and off via the power supply.

For SERIES 400 and 500 devices, R. STAHL recommends you switch off the devices via the respective Windows / Remote Image function.

11.2.2 With optional on/off switch (for SERIES 400 and 500 only)

Switch the device on and off with the connected on/off switch. The switch function is defined via the operating system and functions like a notebook switch.

For SERIES 400 and 500 devices, R. STAHL recommends you switch off the devices via the respective Windows / Remote Image function.

11.3 Teaming function



For SERIES 500 only
(for SERIES 400 only after additional installation of the "Ethernet Chipset Diagnostic Utility Tool")





Teaming function			
Processor	Interface		
	1TX	2TX	2FX
AMD	No	Yes	No
i5	No	Yes	Yes
i7	No	Yes	Yes

- Providing redundancy with an automatic switch to a different network adapter.
- Using the Ethernet adapters in the team as standby adapters, realising redundancy, making the system more fail-safe.
- Bundling the speed of the Ethernet adapters in order to increase performance.



For a description of the function and its settings refer to the Remote HMI V6 software manual (industrial-grade Thin Client firmware).

12 Maintenance, overhaul and repair

 DANGER	<p>Explosion hazard due to damaged seal or leaking of filling material ! Non-compliance may result in fatal or serious injuries !</p> <ul style="list-style-type: none"> • In case of damage or changes to the factory state immediately decommission the device. • Contact manufacturer. • If the device leaks filling material (small glass beads) it must be decommissioned immediately !
 DANGER	<p>Explosion hazard due to incorrect maintenance or repair ! Non-compliance may result in fatal or serious injuries !</p> <ul style="list-style-type: none"> • Ensure the atmosphere is non-explosive. • Make sure that the device is not damaged. • Do not open the enclosure. • If the device is connected to the mains: <ul style="list-style-type: none"> ○ Disconnect the device from the power supply. ○ Isolate supply and all Ex e circuits and wait 5 minutes before opening the terminal boxes.
 WARNING 	<p>Hot surfaces ! Non-compliance may result in minor burns ! In ambient temperatures exceeding +45 °C the surface of the device may heat up.</p> <ul style="list-style-type: none"> • Do not touch the device.

Additional for MT-xx8 HMIs:

Do not open, service or repair in an area where an explosive atmosphere may be present.

12.1 Changing the battery

The internal battery must only be replaced by the manufacturer.

12.2 Servicing

The enclosure is sealed and cannot be opened.

When servicing the device, check the following points in addition to those stipulated in the national regulations:

- Damage to seals: cracks or other visible damage to the device enclosure and / or the protective enclosure.
- All cables and conductors securely connected: cables tightly clamped
- All cables and conductors undamaged
- Compliance with permitted temperature range
- Mounting fits securely, all screws tightened fast
- Ensure the device is used as intended

12.3 Maintenance

The devices are maintenance-free across their entire lifespan.

12.4 Repair

The display and E-box modules cannot be repaired by the customer.

- Any repair on the device is to be performed by R. STAHL only.
- The modules may be sent back separately.
- The modules must be dismantled by qualified staff only (see chapter [3.3 Personnel qualification](#)).

12.4.1 Mounting / dismantling the modules

The xx8 SERIES HMIs consist of a display and an E-Box module which are mounted together. These modules can be replaced for repair purposes.

Dismounting modules:

- Disconnect all circuits from the power supply.
- Remove cover of terminal boxes.
- Disconnect cable and earthing, see Installation Manual "Module exchange xx8 (IM_Module_exchange_xx8)".
- Loosen the screws.

<div style="border: 1px solid black; padding: 5px; width: fit-content; margin: 0 auto;">NOTE</div> 	<p>Possible mechanical or electrical damage to the connectors</p> <p>If the plug-in connectors are not protected by a cover and suitable ESD measures, damage can occur that impair the function of the modules.</p> <p>The connectors are device interfaces that have limited ESD protective measures in terms of design and are designed for service purposes by qualified personnel.</p> <p>Suitable mechanical and ESD protective measures must be taken to avoid damaging the components.</p> <ul style="list-style-type: none"> • Carry out ESD protective measures before dismantling. • Protect the connectors with a cover after dismantling.
--	---

Mounting modules:

The steps for mounting the modules are those described in "Dismounting modules" in reverse.

Tightening torque	
Screws (in the terminal boxes) connecting the display and the E-box	10 Nm

13 Returning the device

Only return or package the devices after consulting R. STAHL. Contact the responsible representative from R. STAHL. R. STAHL's customer service is available to handle returns if repair or service is required.

Contact customer service via E-mail or telephone:

- E: service.dehm@r-stahl.com
- T: +49 221 76806 3000

Requesting a RMA ticket via our website:

- Go to r-stahl.com.
- Under "Support" > "RMA form", select "Request RMA ticket".
- Fill in and send the form.
- You will automatically receive an E-mail with an RMA ticket (PDF).
- Print out the RMA ticket.
- Clearly copy the RMA number onto the outside of the package.
- Send the device with the RMA ticket included in the package to R. STAHL HMI Systems GmbH (see chapter [1.1 Manufacturer](#) for the address).

14 Cleaning

- Check the device for damage before and after cleaning it. Decommission damaged devices immediately.
- Devices located in hazardous areas may only be cleaned with a damp cloth to avoid electrostatic charge.
- When cleaning with a damp cloth, use water or mild, non-abrasive, non-scratching cleaning agents.
- Do not use abrasive detergents or solvents.
- Never clean the device with a strong water jet, such as a pressure washer.

15 Disposal

- Observe national, local and statutory regulations regarding disposal.
- Separate materials for recycling.
- Ensure environmentally friendly disposal of all components according to statutory regulations.

16 Accessories

NOTE	<p>Malfunction or damage to the device due to the use of non-original components.</p> <p>Non-compliance may result in material damage !</p> <ul style="list-style-type: none">• Only use original manufacturer accessories.
-------------	--

17 Appendix A

17.1 Technical data

17.1.1 General

Function / Equipment	ET-438 MT-438	ET-538 MT-538	ET-638 MT-638	ET-498 MT-498	ET-598 MT-598	ET-698 MT-698
HMI-type	Operator Station					
Enclosure type	Rugged Panel Design (RP)					
Enclosure design	VESA 200 Standard, VESA 200 Top Connect					
Weight	ET 25 kg MT 18 kg			ET 35 kg MT 25 kg		
Material (front)	Seawater resistant and coated aluminium, hardened glass					
Material (back)	Seawater-resistant powder coated aluminum					
Degree of protection (IP)	IP66					
Front enclosure protection type (IP)	IP66					
Enclosure back protection type (IP)	IP66					

17.1.2 Electrical data

Function / Equipment	ET-438 MT-438	ET-538 MT-538	ET-638 MT-638	ET-498 MT-498	ET-598 MT-598	ET-698 MT-698
AC rated operational voltage	230 V					
Voltage range AC	100 – 240 V					
DC rated operational voltage	24 V					
Voltage range DC	20 – 30 V					
Power consumption AC 1	0.6 A at 230 VAC (0.8 A with heater)					
Power consumption AC 2	1.1 A at 110 VAC (1.7 A with heater)					
Current consumption DC	4.6 A at 24 VDC (6.9 A with heater)					
Frequency range	50 – 60 Hz					
Rated operational power	typically 100 W / max. 150 W (typically 340 BTU / max. 510 BTU)					
Fuses AC	5 A					
Fuses DC	12 A					
Terminal box	Power supply direct in integrated Ex e terminal box					
Connections	Via plug-in screw terminals, green					
Conductor type	Flexible conductors 0.2 to 2.5 mm ² (AWG24 to AWG14) Rigid conductors 0.2 to 2.5 mm ² (AWG24 to AWG14)					
max. operating voltage Um	250 VAC					
Bluetooth	Yes					
RFID reader	-			optionally integrated C5 or C6		
RFID reader panel-mount type	-			PRIMO-A-1200-A		
RFID data transfer C5	-			CRYPT; 13.56 MHz; LEGIC, MIFARE / DESFire / EV1		
RFID data transfer C6	-			ASCII; 13.56 MHz; LEGIC, MIFARE / DESFire / EV1		
Supported transponder media	-			see Transponder media table		
Interface USB	3x USB (Ex ia) 1x USB (Ex e)					
Plug version USB	USB-A connector					
USB standard	USB 2.0, 480 Mbit/s					
Note on USB interfaces	The USB interfaces are based on USB 2.0. Due to explosion protection rules, the USB interface properties (such as speed or power supply) may be restricted.					

Status displays	LEDs - on / off (green) - power supply on / power supply OK (orange) - heater on
-----------------	---

17.1.3 Display

Function / Equipment	ET-438 MT-438	ET-538 MT-538	ET-638 MT-638	ET-498 MT-498	ET-598 MT-598	ET-698 MT-698
Display-Version	TFT colour display or Sunlight readable display			Sunlight readable display		
Display version 2	16.7 million colours					
Display size inch	15			21.5		
Display size cm	38			55		
Display resolution	XGA			Full HD		
Display total pixels	1024 x 768			1920 x 1080		
Display dimensions	4:3			16:9		
Display brightness	TFT 450 cd/m ² SR 1200 cd/m ²			1000 cd/m ²		
Display contrast	TFT 500:1 SR 600:1			1100:1		
Backlight	LED technology					
Life expectancy backlight	70,000 h at +25 °C					
Function keys	8, of which 2 brightness keys					
Display with touch function						
Touch monitor	Glass touch					
Touch screen technology	projected, capacitive (PCAP), multi-touch					
Touch controller	AMT is supported from - operating system Open HMI Win10 IoT Enterprise 1607 64-bit Rev 1.4.3 onwards - Image Remote HMI V5.70.xx 64-bit					
Touchscreen activation	No activation pressure required					
Touchscreen input method	Fingers, thin glove or special glove, conductive touch pen					
Touch screen durability	very good					
Touchscreen resistance to scratching MoHS scale	>5					
Touchscreen resistance to scratching pencil hardness test ISO 15184	9H					
Touchscreen transmissivity / optics	very good					
Touchscreen surface contaminants	unaffected (however, can be affected by conductive fluids such as saltwater)					
Touchscreen abrasion resistance	no abrasion by finger or rubber					

17.1.4 Ambient conditions

Function / Equipment	ET-438 MT-438	ET-538 MT-538	ET-638 MT-638	ET-498 MT-498	ET-598 MT-598	ET-698 MT-698
Heater operation	Automatic					
Operating temperature range	-10 °C ... +65 °C					
	-40 °C ... +65 °C (with heater)					
Storage temperature	-40 °C ... +70 °C					
Cold start temperature *1	- 10 °C or - 40 °C (with heater)					
Heat dissipation	via heat pipes and cooling fins					
Damp heat	+55 °C / 95 %					
Damp heat cyclic (2x 24 h)	+55 °C (±2 °C) ≥ 95 %					
Corrosion resistance	Saltwater 5 % NaCl / +20 °C / 2 h 93 % RH / +40 °C / 168 h ISA-S71.04-1985, severity G3					
Vibration (sinusoidal)	5 to 13.2 Hz: ±1 mm 13.2 to 100 Hz: ±0.7 g Change cycle 1 oct/min X, Y, Z axes					
Vibration (sinusoidal) 1	5 to 58 Hz: ±0.075 mm 58 to 500 Hz: ±1 g Change cycle 1 oct/min X, Y, Z axes					
Vibration (sinusoidal) 2	5 to 1000 Hz 5 g					
Shock	18 shocks 25 g / 6 ms X, Y, Z axes					
Location classes	according to DNV guideline CG-0339					
	Temperature	D				
	Humidity	B				
	Vibration	A				
	EMC	B*				
	Enclosure	C				

*1 The cold-start temperature depends on the type of outdoor installation (with / without heater).

	<p>Cold start temperature: If the HMI device is switched on at temperatures below -10 °C, the electronics and the display will need a certain warm-up time before everything works smoothly and the display starts to be legible. Depending on how low the temperature is, this process may last up to 3 hours.</p>
	<p>Devices with AMD processor cannot be warm-started in temperatures above +55 °C.</p>
	<p>Location class EMC B*: HMI devices with card reader (option -C5, -C6) are not be used on bridge / open deck.</p>

17.1.5 Mounting

Function / Equipment	ET-438 MT-438	ET-538 MT-538	ET-638 MT-638	ET-498 MT-498	ET-598 MT-598	ET-698 MT-698
Wall cut-out (W x H)	no panel-mount module					
Mounting orientation	any					
Mounting option	Yoke and wall-mounting, handle and feet, sun protection roof, panel mount (with xx8 Mounting-Kit)					
Mounting type	when switched on: a fixed device (stationary, non-portable equipment)					

17.1.6 Mechanical data VESA 200 Standard

Function / Equipment	ET-438 MT-438	ET-538 MT-538	ET-638 MT-638	ET-498 MT-498	ET-598 MT-598	ET-698 MT-698
Dimensions (W x H x D)	380 mm x 394 mm x 137 mm (+52 mm for cable entries)			553 mm x 458 mm x 141 mm (+52 mm for cable entries)		
Cable gland	Type	HSK-MZ-Ex				
	Number					
	Ex i compartment	3x M16				
	Ex e compartment	3x M20, 2x M25				
	Thread size	M16 x 1.5 / M20 x 1.5 / M25 x 1.5				
	Clamping range	M16 = 5 ... 10 mm / M20 = 10 ... 14 mm / M25 = 14 ... 18 mm				
	Width across flats	M16 = SW 19 / M20 = SW 22 / M25 = SW 30				

17.1.7 Mechanical data VESA 200 Top Connect

Function / Equipment	ET-438 MT-438	ET-538 MT-538	ET-638 MT-638	ET-498 MT-498	ET-598 MT-598	ET-698 MT-698
Dimensions (W x H x D)	380 mm x 394 mm x 212 mm			553 mm x 458 mm x 216 mm		
Cable gland	Type	Screw plug				
	Number					
	Ex i compartment	3x M16				
	Ex e compartment	3x M20				
	Thread size	M16 x 1.5 / M20 x 1.5				

17.2 Additional data for SERIES 400 / 500

17.2.1 General

Function / Equipment	ET-438 MT-438	ET-498 MT-498	ET-538 MT-538	ET-598 MT-598
Technology	Panel PC		Thin client	

17.2.2 Electrical data

Function / Equipment	ET-438 MT-438	ET-498 MT-498	ET-538 MT-538	ET-598 MT-598
Processor type	AMD GX-222GC Intel® Core™ i7-3517UE Intel® Core™ i7-3517UE mit TPM Intel® Core™ i5-6442EQ with TPM			
Processor details	AMD: 2.2 GHz; Dual Core, 10W TDP Intel i7: 1.7 GHz; Dual Core, 4 threads, 3. Generation Ivy Bridge, 17W TDP Intel i5: 1.9 GHz (2.7 GHz); Quad Core, 4 threads, 6 MB Cache, 25W TDP			
Graphics controller	AMD: integrated AMD Radeon R5E graphics Intel i7: integrated Intel HD graphics 4000 Intel i5: integrated Intel HD graphics 530			
Main memory	AMD: 4 GB i7: 4 GB / 8 GB i5: 4 GB / 16 GB			
Data memory	AMD	60 GB 128 GB		
	i7 / i5	240 GB 480 GB and i7 with 8 GB RAM / i5 with 16 GB RAM		
operating system	AMD	Windows Embedded Standard 7 Windows 7 Ultimate (64 Bit) * Windows 10 IoT Enterprise 2016 LTSB (64 Bit) *		
	i7	Windows 7 Ultimate (64 Bit) * Windows 10 IoT Enterprise 2019 LTSC (64 Bit) *		
	i5	Windows 10 IoT Enterprise 2019 LTSC (64 Bit) *		
Language support	Multilanguage operating system: en, de, fr, es, it, br, ru, kr		via operating system	
Image	-		Remote firmware	

 * For Windows 7 Ultimate and Windows 10 IoT the 64 Bit version is preinstalled on the device. Additionally, the 32 Bit version of each Windows version is installed on the recovery stick included in the delivery.

17.2.3 Interfaces

Function / Equipment		ET-438 MT-438	ET-498 MT-498	ET-538 MT-538	ET-598 MT-598
Ethernet note		Either TX, 2TX or 2FX			
Ethernet / Data		1x 100/1000Base-TX (Ex e) 2x 100/1000Base-TX (Ex e) 2x 100Base-FX (Ex op is)			
Copper TX	Data cable	CAT7 installation cable AWG23			
	Length of data cable	max. 100 m			
	Interface medium	CAT7 Data transmission			
Fibre optic FX	Data cable	FO cable 50/125 µm or 62.5/125 µm			
	Length of data cable	max. 5000 m (for core cross section 50 and use of 9721/13-11-14) max. 4000 m (for core cross section 62.5 and use of 9721/13-11-14)			
	Interface medium	multi-mode optical fibre cable			
Serial interface		1x RS-232 / RS-422 / RS-485 (Ex e)			
Optional interface 1		WLAN 2.4 GHz (Ex i) WLAN 5 GHz (Ex i)			
Audio interface		1x Audio line out (Ex e) (only with AMD)			
Interface reader		1x reader / barcode reader interface (Ex i)			
WLAN		optional			
WLAN standard		802.11 a/b/g/n/ac			
Bluetooth		Standard			
Bluetooth version		V 2.1 / 3.0 / 4.1 / 4.2			
Front camera		optional, 5 megapixels, in-built			
Further connections		12 / 24 V DC output 2x Fan On/off switch			
Plug version FO		SC duplex socket			



When using the fibre optic interfaces of SHARK devices, they must be connected and safely operated with other devices that comply with the limit values of Class 1 according to IEC 60825-1 or are classified as inherently safe optical radiation "op is" according to IEC 60079-28.

RF output power (without Antenna Gain)

Technology	Frequency (MHz)	P [dBm] E.I.R.P
WLAN 2.4 GHz	2400 – 2483.5	10.4
WLAN 5 GHz	5250 - 5350 / 5470 - 5725	6.8
Bluetooth® + EDR	2400 – 2483.5	-32.3

max. output power = P (dBm) + Antenna Gain (dBi)

17.3 Additional data for SERIES 600 KVM Systems

17.3.1 General

Function / Equipment	ET-638 MT-638	ET-698 MT-698
Technology	KVM System	

17.3.2 Electrical data

Function / Equipment	ET-638 MT-638	ET-698 MT-698
Transfer Technology	KVM-DVI3	
operating system	independent	
Language support	User menu: English	

17.3.3 Interfaces

Function / Equipment	ET-638 MT-638	ET-698 MT-698
Ethernet note	Either TX, SX or LX	
Ethernet / Data	1x 100/1000Base-TX (Ex e) 1x 1000Base-SX (Ex op is) 1x 1000Base-LX (Ex op is)	
Copper TX	Data cable	CAT7 installation cable AWG23
	Length of data cable	max. 150 m
	Interface medium	CAT7 Data transmission
Optical fibre SX	Data cable	FO cable 50/125 µm or 62.5/125 µm
	Length of data cable	max. 550 m (with core diameter of 50 µm) max. 300 m (with core diameter of 62.5 µm)
	Interface medium	multi-mode optical fibre cable
Optical fibre LX	Data cable	FO cable 9/125 µm
	Length of data cable	max. 10,000 m
	Interface medium	Single mode optical cable
Serial interface	1x RS-232 / RS-422 / RS-485 (Ex e)	
Audio interface	1x Audio line out (Ex e)	
Interface reader	1x reader / barcode reader interface (Ex i)	
Front camera	optional, 5 megapixels, in-built	
Further connections	12 / 24 V DC output 2x Fan	
Plug version FO	SC duplex socket	



When using the fibre optic interfaces of SHARK devices, they must be connected and safely operated with other devices that comply with the limit values of Class 1 according to IEC 60825-1 or are classified as inherently safe optical radiation "op is" according to IEC 60079-28.

17.4 Transponder media table

Transponder media	Reader technology
MIFARE Classic, 1k / 4k	MIFARE Classic
DESFire, 4k	MIFARE DESFire
DESFire EV1, 2k / 4k / 8k	MIFARE DESFire EV1
LEGIC MIM 22 / MIM 256 / MIM 1024	LEGIC prime
LEGIC ATC512-MP110 (ISO 14443A) LEGIC ATC2048-MP110 (ISO 14443A) LEGIC ATC4096-MP310 (ISO 14443A) LEGIC ATC4096-MP311 (ISO 14443A) LEGIC AFS4096-JP10 / JP11 (ISO 14443A) LEGIC ATC128-MV210 (ISO 15693) LEGIC ATC256-MV210 (ISO 15693) LEGIC ATC1024-MV110 (ISO 15693)	LEGIC advant
ISO 14443A transponder (UID / CSN) ISO 15693 transponder (UID / CSN) Sony FeliCa subset INSIDE Secure (UID / CSN) Transparent, NFC Forum Type 2 Tag Transparent, NFC Forum Type 3 Tag	General

17.5 Overview Hardware Revision ET-xx8 / MT-xx8

HW-Rev.	Device type	Technical modifications	Modification date Hardware	BA version	BA date
01.00.00	ET-xx8 MT-xx8	Certification status	2014-10-06	01.00.01	2014-11-14
01.01.00	ET-xx8 MT-xx8	Certificate 1. Supplement	2017-04-28	01.01.00	2017-05-29
01.01.01	ET-xx8 MT-xx8	Modification module C5 and C6 Ship approvals	2017-11-27	01.01.04	2017-12-19
01.01.02	ET-/MT-4x8 ET-/MT-5x8	New AMD processor	2018-07-01	01.01.07	2018-07-24
01.01.03	ET-xx8 MT-xx8	New touch controller	05/2020	01.01.12	2020-05-15
01.01.04	ET-/MT-4x8 ET-/MT-5x8	i5 processor	06/2020	01.01.12	2020-05-15
01.01.05	ET-xx8 MT-xx8	Change of cable gland M16	07/2021	01.02.04	2022-03-25
01.01.06	ET-xx8 MT-xx8	WLAN module WMU6204	04/2022		

18 Appendix B

18.1 Connection values

Nominal voltage	Input voltage range	Rated frequency	max. power consumption
100 – 240 VAC	85 – 250 VAC	50 – 60 Hz	5 A (with heater on)
24 V DC	20 – 30 VDC	–	8 A (with heater on)

18.2 Intrinsically safe interfaces (Ex ia)

For field wiring refer to Control Drawing 11100025 Taken together with this document, the Control Drawing contains information on the connection and the electric parameters.

18.2.1 X30 PB – on/off switch

X30: PB, on/off switch (X30-1, X30-2) parallel wiring, GND (X30-3, X30-4):

Max. output voltage	U_o	=	5.36	VDC	
Max. output current	I_o	=	46	mA	
Max. output power	P_o	=	0.061	W	
Trapezoidal output characteristics					
Max. external capacitance	C_o	=	65	10	μF
Max. external inductance	L_o	=	1	20	μH

C_o and L_o pairs directly above / underneath each other may be used.

18.2.2 X31 - Fan

X31 Fan power (X31-1), (X31-3) per circuit, GND (X31-2, X31-4):

Max. output voltage	U_o	=	15.75	VDC	
Max. output current	I_o	=	189	mA	
Max. output power	P_o	=	1.092	W	
Trapezoidal output characteristics					
Max. external capacitance	C_o	=	0.29	0.478	μF
Max. external inductance	L_o	=	100	20	μH

C_o and L_o pairs directly above / underneath each other may be used.

18.2.3 X32 – Barcode / card reader

- Devices connected to X32 may be connected to the supply circuit via: 10.4 V (X32-1) or 5.36 V (X32-2).
- Terminals 1 and 2 may not be used simultaneously.
- Terminal block X32 contains a joint terminal (X32-5) for the GND of the supply and data line.
- If the connection cable of the connected device uses only a joint GND line, the joint current must be taken into account when determining external inductances.

X32 – Barcode / card reader 10.4 V supply (X32-1), GND (X32-5):

Max. output voltage	U_o	=	10.4	VDC	
Max. output current	I_o	=	391	mA	
Max. output power	P_o	=	2.253	W	
Trapezoidal output characteristics					
Max. external capacitance	C_o	=	2.52	1.2	μF
Max. external inductance	L_o	=	20	100	μH

C_o and L_o pairs directly above / underneath each other may be used.

X32 – Barcode / card reader 5.36 V supply (X32-2), GND (X32-5):

Max. output voltage	U_o	=	5.36	VDC	
Max. output current	I_o	=	420	mA	
Max. output power	P_o	=	1.213	W	
Trapezoidal output characteristics					
Max. external capacitance	C_o	=	65	45	μF
Max. external inductance	L_o	=	1	2	μH

C_o and L_o pairs directly above / underneath each other may be used.

X32 – Barcode / card reader data line TXD (X32-3), RXD (X32-4) per circuit, GND (X32-5):

Max. output voltage	U_o	=			
between RxD and GND or TxD and GND			± 5.35	VDC	
between RxD and TxD			± 10.70	VDC	
Effective internal capacitance	C_i	=	negligible		
Effective internal inductance	L_i	=	negligible		
Max. output current	I_o	=	16	mA	
Max. output power	P_o	=	0.022	W	
Max. input voltage	U_i	=	± 12.5	VDC	
Trapezoidal output characteristics					
Max. external capacitance	C_o	=	2.23	2.23	μF
Max. external inductance	L_o	=	1	20	μH

C_o and L_o pairs directly above / underneath each other may be used.

	The stated external capacitances and inductances were calculated for the maximum voltage of 10.7 V.
---	---

If only one of the two signals, RxD or TxD, are connected, the maximum voltage to be used for calculations is reduced to 5.35 V. The following values are permissible:

Max. external capacitance	C_o	=	65	45	μF
Max. external inductance	L_o	=	1	2	μH

18.2.4 X33 / X34 – USB KB/M

X33 / X34 – USB KB/M terminals + (X33/34-1), D- (X33/34-2), D+ (X33/34-3), GND (X33/34-4):

Max. output voltage	U_o	=	5.36	VDC				
Max. output current	I_o	=	249.85	mA				
Max. output power	P_o	=	0.518	W				
Trapezoidal output characteristics								
Max. external capacitance	C_o	=	65	46	32	25	21	μF
Max. external inductance	L_o	=	0.68	1.68	2.68	3.68	4.68	μH

C_o and L_o pairs directly above / underneath each other may be used.

18.2.5 X35 – USB

X35 – USB terminals + (X35-1), D- (X35-2), D+ (X35-3), GND (X35-4):

Max. output voltage	U_o	=	5.36	VDC				
Max. output current	I_o	=	1.264	A				
Max. output power	P_o	=	2.949	W				
Trapezoidal output characteristics								
Max. external capacitance	C_o	=	65	44	30	23	19	μF
Max. external inductance	L_o	=	0.68	1.68	2.68	3.68	4.68	μH

C_o and L_o pairs directly above / underneath each other may be used.

18.2.6 X36 / X37 – RF1 / RF2

X36 / X37 – RF1 / RF2, Typ W02, W05, W22, W55, W25 per circuit:

Radio frequency	f_o	=	2.4 ... 5	GHz
Max. RF threshold power	P_o	=	17 (50)	dBm (mW)

Calculating the RF threshold power

- Make sure that the RF threshold power radiated from the antenna does not exceed 33 dBm (2 W) for Gas Group IIC.
- The calculation of the threshold power should take into account the output power of the interface and the gain of the antenna. Any losses from the cable can also be included in this calculation.

Example of RF threshold power calculation:

Output power of the interface X36 / X37	17 dBm (50 mW)
Coaxial cable power dissipation	2dB
Antenna gain	5 dBi

RF threshold power radiated from the antenna =
 17 dBm – 2 dB + 5 dBi = 20 dBm (100 mW)

In this example, the coaxial cable and the antenna comply with the requirements of Gas Group IIC, since 20 dBm (100 mW) < 33 dBm (2 W).

Requirements for Wi-Fi antennae

Subject	Required value	Directive
Earthing requirement	–	IEC 60079-14 : 2014 section 16.2.3 local installation requirements (such as NEC or CEC)
Radio frequency	2.4 Ghz	ETSI EN 300 328 V2.1.1 (2016-11)
Radio frequency inside buildings	5 Ghz	Australian RCM and ACMA directives

18.3 Bluetooth – B1

Radio frequency	f_o	=	2.4	GHz
Max. RF threshold power	P_o	=	33 (2)	dBm (W)

18.4 RFID reader interface – RF1, RF2

Radio frequency				
• Type RF1	f_o		13.56	MHz
• Type RF2	f_o	=	2.4	GHz
Max. RF threshold power	P_o	=	33 (2)	dBm (W)

18.5 Inherently safe optical interfaces (Ex op is)

18.5.1 X20 / X21 – FO 1 / FO 2 type FX

Wavelength	=	1310	nm
Nominal optical radiated power	=	0.344	mW
Max. optical radiated power under fault conditions	=	35	mW

18.5.2 X20 / X21 – FO 1 / FO 2 type SX

Wavelength	=	850	nm
Nominal optical radiated power	=	0.22	mW
Max. optical radiated power under fault conditions	=	35	mW

18.5.3 X20 / X21 – FO 1 / FO 2 type LX

Wavelength	=	1310	nm
Nominal optical radiated power	=	0.22	mW
Max. optical radiated power under fault conditions	=	35	mW

18.5.4 X22 – FO 3 type OSX

Wavelength	=	850	nm
Nominal optical radiated power	=	0.22	mW
Max. optical radiated power under fault conditions	=	35	mW

18.5.5 X22 – FO 3 type OLX

Wavelength	=	1310	nm
Nominal optical radiated power	=	0.22	mW
Max. optical radiated power under fault conditions	=	35	mW

18.6 Non intrinsically safe interfaces (Ex e)

18.6.1 X1 – Power supply

Nominal voltage				
• Device version AC		=	100 ... 240	VAC
• Device version DC		=	20 ... 30	VDC
Nominal current				
• Device version AC		=	Max. 5	A
• Device version DC		=	Max. 8	A
Nominal power				
		=	150	W
Max. input voltage	U_m	=	250	VAC
Frequency for AC		=	50 – 60	Hz

18.6.2 X2 / X3 – copper1 / copper2

Nominal voltage		=	5	VAC / VDC
Max. input voltage	U_m	=	250	VAC

18.6.3 X4 – DC out

Nominal voltage terminal 1		=	12	VDC
Nominal voltage terminal 4			24	VDC
Max. input voltage	U_m	=	250	VAC

18.6.4 X5 – CAN

Nominal voltage		=	5	VAC / VDC
Max. input voltage	U_m	=	250	VAC

18.6.5 X6 – USB

Nominal voltage		=	5	VAC / VDC
Max. input voltage	U_m	=	250	VAC

18.6.6 X7 – RSxxx

Nominal voltage		=	12	VAC / VDC
Max. input voltage	U_m	=	250	VAC

18.6.7 X8

NOTE	Not in use ! Do not connect anything !			
-------------	--	--	--	--

18.6.8 X9 – Audio / Video

Nominal voltage		=	5	VAC / VDC
Max. input voltage	U_m	=	250	VAC

18.6.9 X10 – SATA

Nominal voltage		=	5	VAC / VDC
Max. input voltage	U_m	=	250	VAC

19 Appendix C

19.1 Connection overview terminal assignment

19.1.1 Ex e terminal box / terminals

Terminal	Pin	Designation (PCB) / view		typical colour coding / plug type	Connection / function
X1	1	+24 V / L		Black	Power supply of the HMI device (either AC or DC)
POWER	2	+24 V / L		Black	
	3	GND / N		Blue	
	4	GND / N		Blue	
	5	PE / earth		Green / yellow	
	6	PE / earth		Green / yellow	
X2 *		1000Base-TX	100Base-TX		Data cable
CAT1	1	D1+	TX+	Orange / White	Copper connection 1
	2	D1-	TX-	Orange	
	3	D2+	RX+	Green / White	
	4	D2-	RX-	Green	
	5	D3+		White / Blue	
	6	D3-		Blue	
	7	D4+		White / Brown	
	8	D4-		Brown	
X3 *		1000Base-TX	100Base-TX		Data cable
CAT2	1	D1+	TX+	Orange / White	Copper connection 2 (2. Connection not possible for SERIES 600)
	2	D1-	TX-	Orange	
	3	D2+	RX+	Green / White	
	4	D2-	RX-	Green	
	5	D3+		White / Blue	
	6	D3-		Blue	
	7	D4+		White / Brown	
	8	D4-		Brown	
X20 * FO 1				SC duplex connector	Data cable FO connection 1 for SERIES 400 / 500 Type FX (100Base-FX) for SERIES 600: Type SX (1000Base-SX) or Type LX (1000Base-LX)

X21 * FO 2		SC duplex connector	Data cable FO connection 2 (2. Connection not possible for SERIES 600) for SERIES 400 / 500 Type FX (100Base-FX)
---------------	---	------------------------	---



* Ethernet connection is available in two versions: copper or fibre optic (see order versions).
SERIES 600 devices only have one Ethernet connection. Although SERIES 600 devices have the X3 terminal block (CAT2), this is not assigned / connected.

Terminal	Pin	Designation (PCB) / view			typical colour coding / plug type	Connection / function
X4 DC out	1	+12 V				12 and / or 24 VDC Output max. load 500 mA per output
	2	GND				
	3	GND				
	4	+ 24 V				
X5 CAN	1	CAN1 L				CAN bus connection (no longer available)
	2	CAN1 H				
	3	CAN2 L				
	4	CAN2 H				
X6 USB	1	+5 V			Red	USB connection USB 2.0 max. load 500 mA
	2	D -			White	
	3	D +			Green	
	4	GND			Black	
X7 RSxxx		RS-232	RS-422	RS-485		Serial interface (COM) RS-232 / RS-422 / RS-485
	1	TxD	TxD-A	A		
	2	RxD	RxD-B			
	3	RTS	TxD-B	B		
	4	CTS	RxD-A			
	5	GND				
X8						Not in use

X9 Audio / Video	1	L out		Audio / video connection
	2	R out		Line out left
	3	GND		Line out right
	4	Video		(audio only for AMD and SERIES 600)
	5	GND		Video input (not possible for SERIES 600)

19.1.2 Ex i terminal box / terminals

Terminal	Pin	Designation (PCB) / view	typical colour coding / plug type	Connection / function
X30 PB	1	PB		on/off switch connection (not possible for SERIES 600)
	2	GND		
	3	GND		
	4	GND		
X31 FAN	1	+FAN		Fan connection
	2	GND		
	3	+FAN		
	4	GND		
X32 RS232 / Power	1	+10.4V		Barcode / card reader connection
	2	+5.4V		
	3	GND		
	4	RxD		
	5	TxD		
X33 USB	1	+5 V	Red	USB connection
	2	D -	White	
	3	D +	Green	
	4	GND	Black	
X34 USB	1	+5 V	Red	USB connection
	2	D -	White	
	3	D +	Green	
	4	GND	Black	
X35 USB	1	+5 V	Red	USB connection (Terminals or sockets)
	2	D -	White	
	3	D +	Green	
	4	GND	Black	
			USB socket Type A	

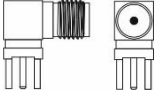
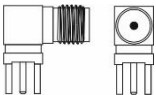
X36			SMA reverse socket	WLAN Antenna connection 1 (not possible for SERIES 600) (for 2.4 GHz antenna)
X37			SMA reverse socket	WLAN Antenna connection 2 (not possible for SERIES 600) (for 5 GHz antenna)

20 Appendix D

20.1 Variation of operating temperature range

The devices' operating temperature range is impacted by how they are mounted, and the minimum and maximum permitted operating temperature may vary depending on their mounting type.



These values are listed in the table below.





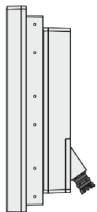

NOTE	Exposure to direct sunlight might contribute to a further heating up of the device and may result in a further reduction of the maximum permitted operating temperature ! We recommend you protect the device from direct sunlight !
	Wind may cool down the device and thus have an impact on the minimum operating temperature.

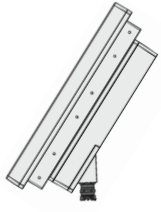
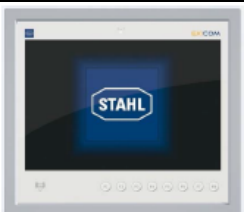
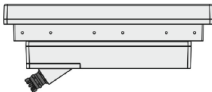
	The storage temperature is not impacted by the type of installation.
---	--

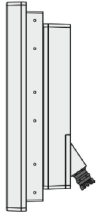
As a rule:

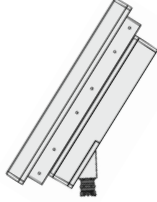
- LTC = Lower ambient temperature in °C
-40 °C for devices with integrated heater
-10 °C for devices without heater
- LTF = Lower ambient temperature in °F
-40 °F for devices with integrated heater
+14 °F for devices without heater
- HTC = Highest permissible ambient temperature in °C
- HTF = Highest permissible ambient temperature in °F

Display orientation	Inclination	Description	Highest permissible ambient temperature
		Landscape, horizontal 90°, standing free	HTC = +65 °C HTF = +149 °F
		Landscape, horizontal 45°, standing free	HTC = +60 °C HTF = +140 °F
		Landscape, horizontal 0°, standing free, minimum gap 10 cm below device	HTC = 60 °C HTF = +140 °F

Display orientation	Inclination	Description	Highest permissible ambient temperature
		Portrait, vertical 90°, standing free	HTC = +60 °C HTF = +140 °F
		Portrait, vertical 45°, standing free	HTC = +60 °C HTF = +140 °F
		Landscape, horizontal, installation in enclosure, inclination independent	HTC = +50 °C HTF = +122 °F
		Portrait, horizontal, installation in enclosure, inclination independent	HTC = +50 °C HTF = +122 °F

21 Appendix E

21.1 Disposal / Restricted substances

Disposal of old electric and electronic devices, packaging and used parts is subject to regulations valid in whichever country the device has been installed.

For countries under the jurisdiction of the EU the corresponding WEEE directive applies.

The devices are classified according to the table below:

Directive	WEEE II directive 2012/19/EU
Valid	from 2018-08-15
Category	SG2 screens, monitors, devices with monitors >100 cm ²

R. STAHL HMI Systems GmbH meets the requirements of directive 2012/19/EU (WEEE) and is registered under the number DE 15180083.

We shall take back our devices according to our General Terms and Conditions.

21.1.1 Declaration of substances and restricted substances

The present declaration is based on the procedure described in the international standard and directives as listed in the table below:

- IEC 62474 : 2018 (DIN EN IEC 62474 : 2019-09)
- (EG) Nr. 1907/2006 (REACH)
- Directive 2011/65/EU (RoHS)
- Resolution MEPC.269(68) "International Maritime Organization" (IMO); particularly "2015 Guidelines for the Development of the Inventory of the Hazardous Materials" (IHM)

21.1.1.1 Declarable substance groups

ECHA Legal Entity UUID of the R. STAHL HMI Systems GmbH:
ECHA-a4dd94d5-bcd2-405d-8fdd-010a535d7e87

SCIP number: 6645ed62-9ed5-4379-a02d-1e99e5be3300

Component	Name	Mass (g)	Declarable Substance Groups and Substances (IEC 62474 database)	CAS No.	Mass %	Exemption (acc. to directive)
BR2032	Lithium button cell battery AMD boards	2.6	Dimethoxyethane (1,2 Dimethoxyethane / DME)	110-71-4	3.6104	-
BR2450A	Lithium button cell battery i5 boards	4.9	no SVHC			-
BR-1/2AA	Lithium button cell battery i7 boards	25.5	no SVHC			

21.1.1.2 ROHS directive 2011/65/EC

The devices meet the requirements of RoHS Directive 2011/65/EU.

21.1.1.3 IMO Resolution MEPC.269(68)

The devices meet the requirements of the MEPC.269(68) Resolution of the "International Maritime Organization" (IMO), in particular the "2015 Guidelines for the Development of the Inventory of the Hazardous Materials" (IHM).

22 Appendix F

22.1 Defective pixels

As a result of the manufacturing process (production tolerances and errors) the displays may be delivered with defective pixels. These potential defective pixels are not a display or HMI error or defect, provided they are within the range of the specification below.

22.1.1 Terminology

Defective pixels Pixels or sub-pixels that do not perform as expected and are either always on or always off.

Pixel Image point on the display consisting of 3 sub-pixels in the basic colours red, green and blue.



Dot Sub-pixel in the basic colour red, green or blue.



Bright Sub-pixel (dot) to which light is passing through, creating a bright dot that is on

Dark off Sub-pixel (dot) to which no light is passing through, creating a dark dot that is

adjacent dots dots positioned next to one another, horizontally, vertically or diagonally, bright or dark (e.g. the following pattern and sub-pixels)

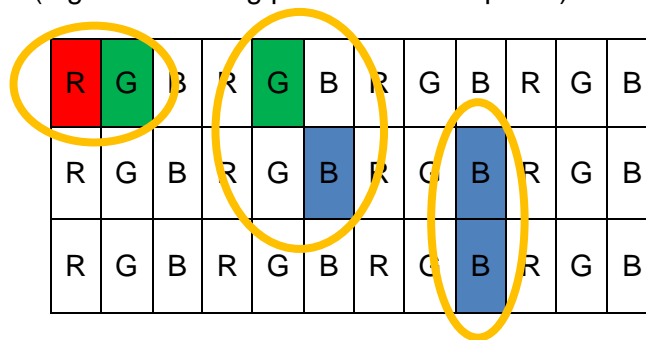

Distance between Dots Definition of distance between two defective dots horizontal, vertical or diagonal, bright or dark (e.g. the following pattern and sub-pixels)

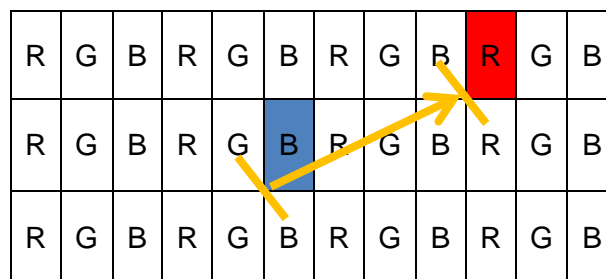

22.1.2 Display specification

Type of defect / description	max. number of permitted defects		
	15" SR Display	15" display	21.5" SR Display
Linear defect (horizontal, vertical)	not acceptable		
Defective pixels			
bright dots	≤ 3	≤ 2	≤ 2
dark dots	≤ 3	≤ 3	≤ 5
total number of dots	≤ 5	≤ 3	≤ 5
adjacent dots			
2 bright dots	≤ 1 pair	≤ 0 pair	≤ 1 pair
more than 3 bright dots	not acceptable		
2 dark dots	≤ 1 pair	≤ 1 pair	≤ 2 pairs
more than 3 dark dots	not acceptable		
Distance between the dots			
between 2 bright dots	not defined	≥ 15 mm	≥ 15 mm
between 2 dark dots	not defined	≥ 15 mm	≥ 15 mm
between 1 bright and 1 dark dot	not defined	≥ 15 mm	≥ 15 mm
ND filter for mura effects, bright and dark dots	View with 5% filter	View with 5% filter	View with 6% filter

22.2 Optical specification front glass

For glass with a surface of > 0.1 m² to ≤ 0.35 m²

Type of defect / description	Value	Corresponds to specification on the basis of DIN10110
Largest point defect	max. 0.4 mm ²	0.63 - 1 mm
max. number	7	
Additional small point defects	max. 0.16 - 0.4 mm ²	0.4 – 0.63 mm
max. number	7	
In general, any number of point defects smaller than the following specified surface are always permitted, that is, they are not considered to be defects.		
Surface	< 0.16 mm ²	< 0,4 mm
Scratches		
max. width	0.16 mm	
max. number	7	
max. length	42 mm	
Cumulative length of all scratches	42 mm	
In general, any number of scratches narrower than the following specified width are always permitted, that is, they are not considered to be defects.		
Width	< 0.16 mm	
Minimum distance of defects	70 mm	



The defect sizes are listed here as the square root of the surface in mm.

$$defect\ size = \sqrt{defect\ length * defect\ width}$$

22.2.1 Test criteria

Test setup: transmitted light / transmission

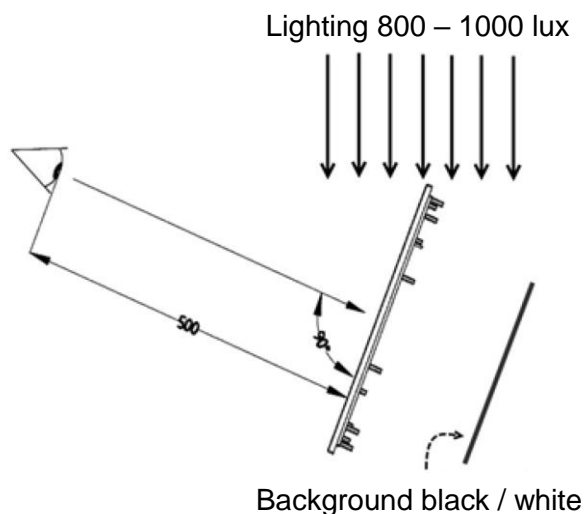

Test setup: Reflexion

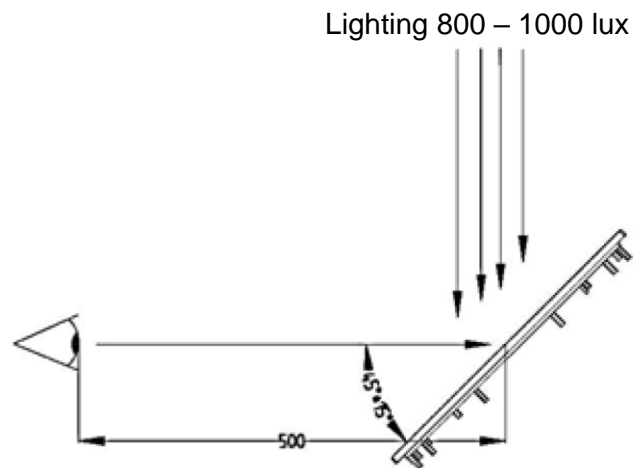

Tester	trained, experienced person with normal eyesight
Distance tester to tested object	500 mm
Viewing angle (to surface)	
for transmitted light / transmission	90°
for reflexion	30° - 60°
Lighting	Standard, 800 - 1000 lx standard light D50 or D65
Test light density	Light table with 500 lux

22.3 Optical acceptance of surfaces

This section covers the acceptance criteria applicable to the minimum requirements for surfaces of devices and components.

The values for imperfection types listed under "tolerance limits" do not constitute a defect or an imperfection of the device or component and must therefore be tolerated.

22.3.1 Optical acceptance glass

Imperfection type	Criterion	Tolerance limits
Total imperfections	Number	Max. 3
Cleanness of glass surface	Clearly visible dirt	not permitted
Edge crack / incipient crack	visible	not permitted
Scratches	Width	up to 0.16 mm
	Length	up to 40 mm
	Cumulative length of all scratches	max. 40 mm
	Long side of glass < 300 mm, distance > 70 mm	
	Number	2
	Long side of glass 300 - 600 mm, distance > 70 mm	
	Number	3
Hairline scratches / scraper damage	Width	max. 0.05 mm
	Length	max. 40 mm
Large point defects	Size	max. 0.4 mm ²
	Number	2
Small point defects	Size	max. 0.16 - 0.4 mm ²
	Number	5
Permitted point defects	Size	< 0.16 mm ² , provided there is no cluster ***
Interference points	Ø < 0.2 mm	permitted
	0.2 mm < Ø ≤ 0.6 mm	permitted provided there is no cluster ***
	0.6 mm < Ø ≤ 1.3 mm	5
	1.3 mm < Ø ≤ 2.0 mm	2
	Ø > 2.0 mm	not permitted
Inhomogeneity *	minor colour variations	permitted
White haze **	only visible in reflection	permitted
	not visible when device is in operating position.	permitted

	* in the case of coated float glass, inhomogeneity in the form of minor colour variations can occur and cannot be prevented by any technical means.
	** large, cloudy blemish, can be more pronounced towards the centre of the glass, but can also affect larger parts of the glass.
	*** a cluster is an accumulation of more than 7 disregarded, permitted imperfections that occur within an inspected area of a diameter of 40 mm.

22.3.2 Optical acceptance printing

Description	Tolerance limits
Labelling	Clearly legible, minimum stroke weight 0.3 mm
Characters	clearly legible
Lines and symbols	Gaps not permitted
Ink coverage	sufficient if underlying layers and structures not visible
Acutance	+/- 0.15 mm
Edge blurring	+/- 0.15 mm
Print overlap	possible colour variations in the overlap area are permitted
Variations of stroke weight	10 %
Within a shaping print	"Fine" as specified in DIN ISO 2768-1 General tolerance class
Between shaping prints	< 400 mm +/- 0.3 mm ≥ 400 mm +/- 0.5 mm

Imperfection type	Criterion	Tolerance limits
Dirt and dust particle inclusions, stains, fluff,	Size	max. 0.16 mm ²
	Size for weak colour contrast	max. 0.25 mm ²
	Number / 100 cm ²	1
	Minimum distance	80 mm
	Lower limit	0.063 mm ²





22.3.3 Optical acceptance, other surfaces

Definitions

Scratch	straight or curved / wavy surface damage
Dents / dings	plastic deformation inwards or outwards
Scuff mark without dent	"punch mark"-type depression

Surface categories

If not specified otherwise in the drawing, the following applies:

A surface	Surface is frequently viewed, typically the front plate. Surface is in customer's field of vision
	Colour code 
B surface	Surface is occasionally viewed, typically the sides of the device
	Colour code 
C surface	Surface is rarely viewed, typically the back or bottom of device
	Colour code 
D surface	Surface is never viewed, typically the inside of the device
	Colour code 

Accessories such as stand, wall bracket etc. are termed C surfaces

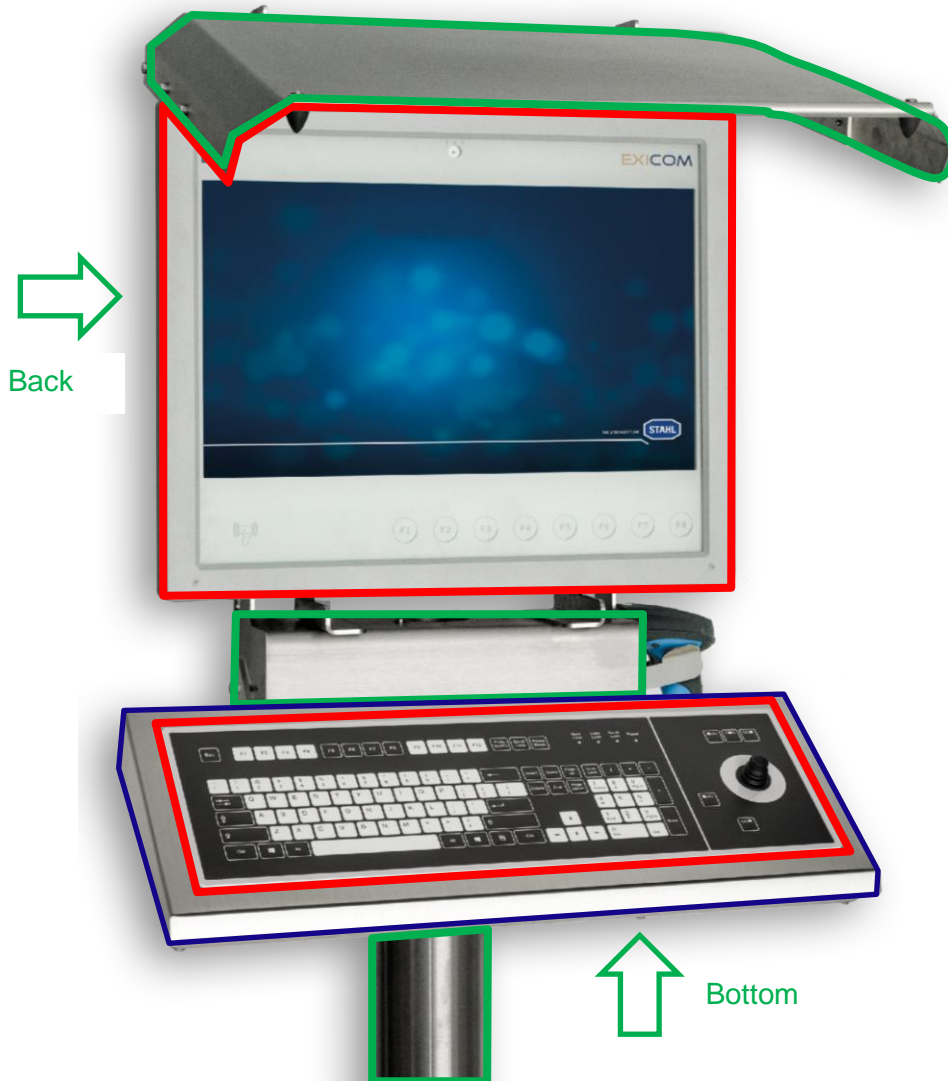

Imperfection type	A surface	B surface	C surface	D surface
Scratches	max. 1 per side	max. 2 per side	1x up to 100 mm with the grain	permitted
	0.05 – 0.1 mm wide and max. 10 mm long	0.05 – 0.1 mm wide and max. 10 mm long		
	or	or	and	
	0.01 – 0.05 mm wide and max. 40 mm long	0.01 – 0.05 mm wide and max. 40 mm long	3x up to 15 mm against the grain	
	only with the grain	only with the grain	1x up to 30 mm against the grain	
Gouges, depressions (punch-mark-type depression)	not permitted	not permitted	max. 2 per side	permitted
			max. 0.3 mm wide	
			max. 3 mm long	
Dents / cavities	not permitted	not permitted	not permitted	not permitted
welding flaws	not permitted	not permitted	not permitted	not permitted
Chatter marks	not permitted	not permitted	not permitted	not permitted
Material flaws	not permitted	not permitted	not permitted	not permitted
Orange peel: surface not homogeneous	not permitted	not permitted	not permitted	permitted

23 Appendix G

23.1 Panel mount with xx8 Mounting-Kit

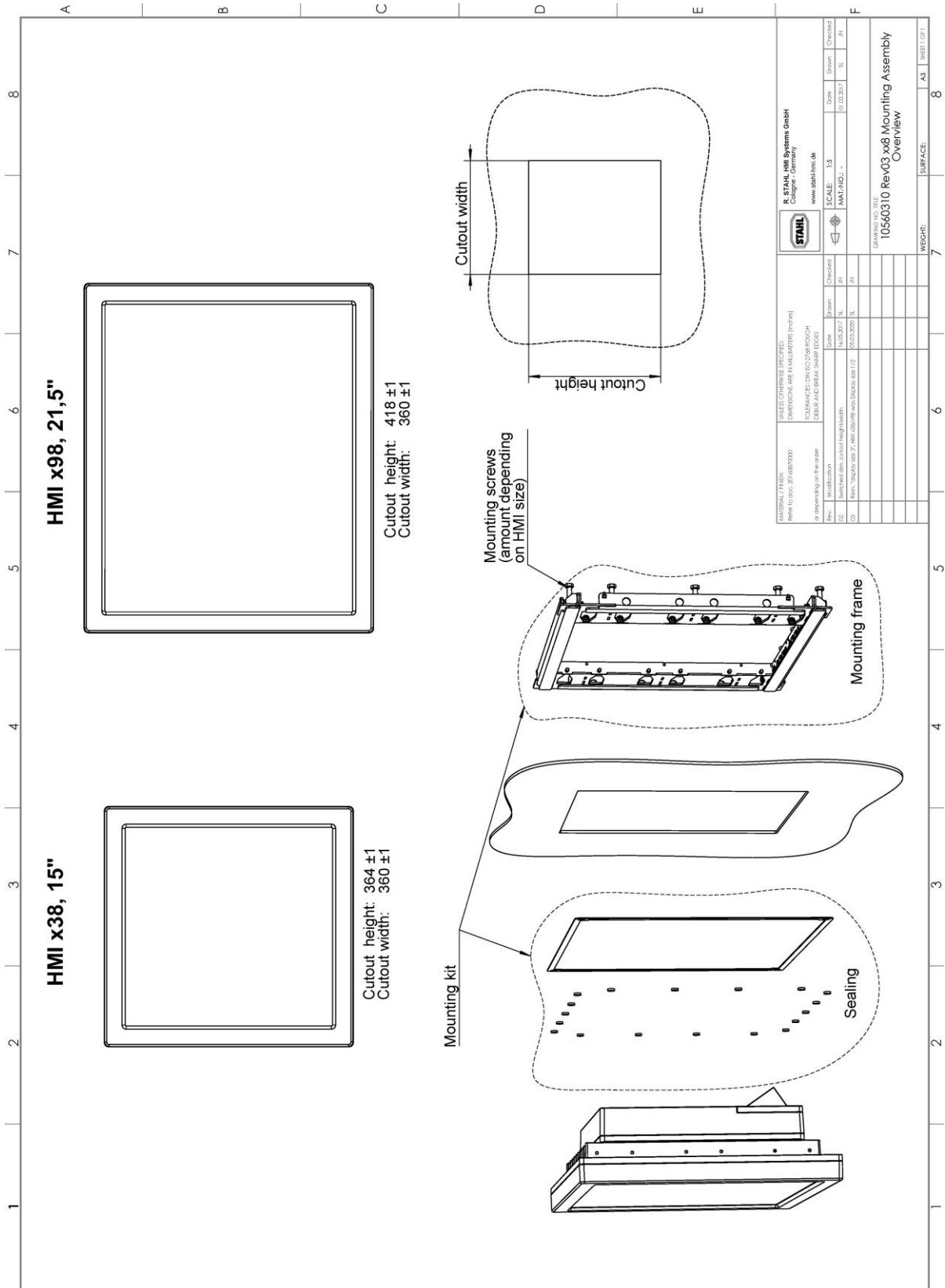

All rights reserved. Without our express consent this image may not be copied, reproduced or used in any other way not intended by the owner.
 Alle Rechte vorbehalten! Diese Zeichnung darf ohne unsere ausdrückliche Zustimmung weiterverbreitet, noch Dritten zugänglich gemacht werden, außerdem darf sie durch den Empfänger oder Dritte nicht in anderer Art und Weise missbräuchlich verwendet werden.
 Stand der Technik - Technische bzw. konstruktive Änderungen vorbehalten.
 State of the art - subject to technical or design alterations.

23.2 Control Drawing – FM USA / Canada

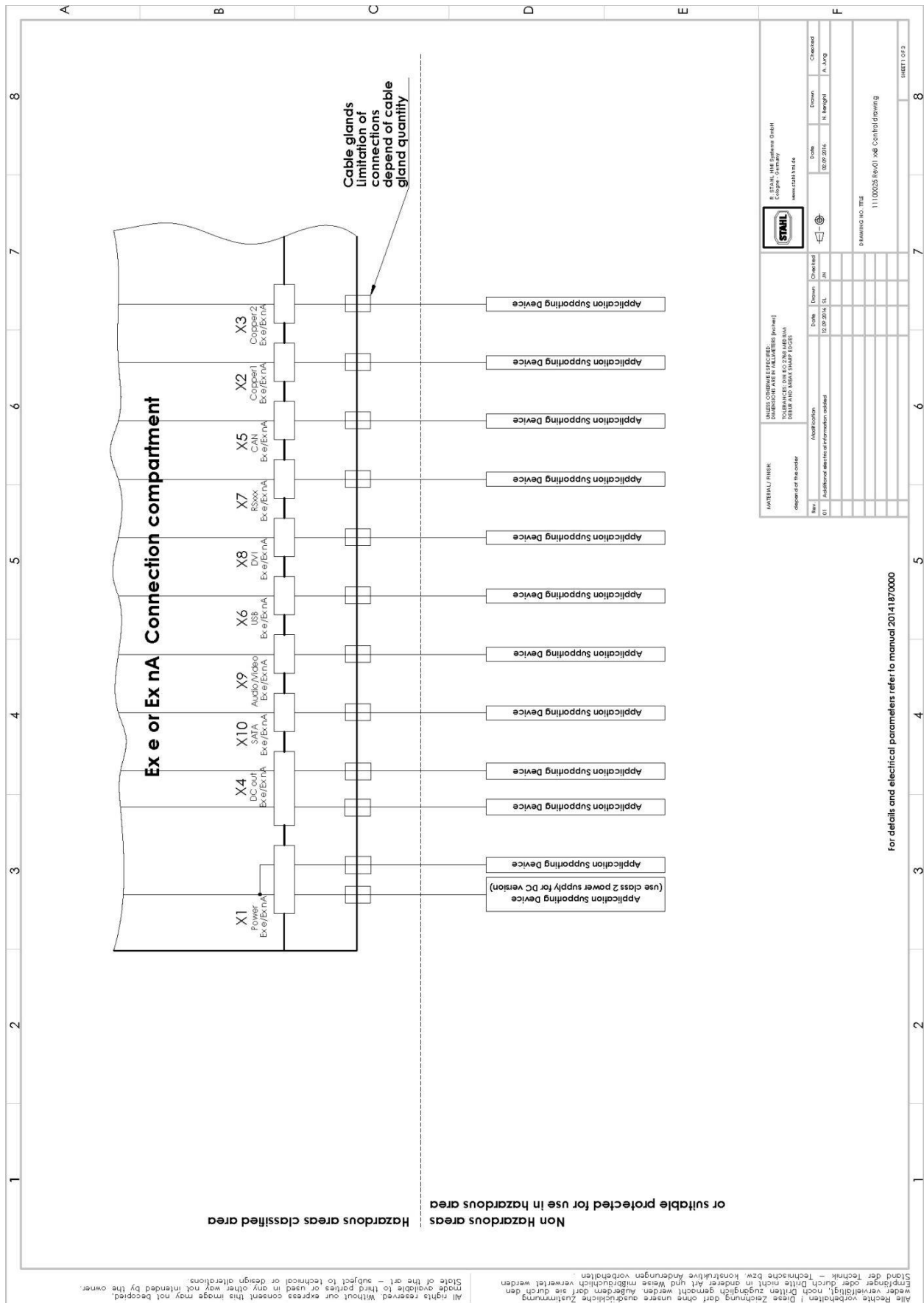

1	2	3	4	5	6	7	8																																																		
Security Advices																																																									
<p>1. No revision to drawing prior to certification body. 2. The Associated Apparatus must be approved by a NRTL. 3. Manufacturer's installation drawing must be followed when installing associated apparatus. 4. Interconnection of equipment apparatus type of protection „I.S.“ with associated apparatus is allowed when the following is true:</p> <p>I.S. Equipment Associated Apparatus $V_{max} \geq U_o$ $I_{max} \geq I_o$ $P_i \geq P_o$ $C_i + C_{cable} \leq C_o$ $L_i + L_{cable} \leq L_o$</p>																																																									
<p>WARNING: - Substitution of components may impair Safety. - To prevent ignition of flammable or combustible atmospheres disconnect power and wait a minimum of 5min. before servicing.</p>																																																									
<p>The ET-xx8 operator interfaces and connected devices must be integrated in the same system of potential equalization. As an alternative to this, only devices hat are isolated from earth potential may be connected.</p>																																																									
<p>All circuits must be wired as specified in the: National Electric Code NFPA70 for installation within United State. Canadian Electric Code for installation within Canada.</p>																																																									
Calculation of cable length																																																									
<p>1.) Determination of maximum possible capacitance of cable: $C_{max} = C_o - C_i$ (associated Apparatus) Determination of maximum possible inductance of cable: $L_{max} = L_o - L_i$ (associated Apparatus)</p> <p>2.) Determination of maximum possible cable length by capacitance and inductance of cable: $length\ C = \frac{C_{max}}{C_{cable}} (*1)$ $length\ L = \frac{L_{max}}{L_{cable}} (*1)$</p> <p>3.) Determination of maximum length of cable: length C or length L, whatever is less. (*1) when cable parameters are unknown, the following values may be used: $C_{cable} = 60\ pF/ft.\ (200\ pF/m)$ $L_{cable} = 0.2\ \mu H/ft.\ (0.66\ \mu H/m)$</p>																																																									
<table border="1" style="width: 100%; border-collapse: collapse;"> <tr> <td colspan="2" style="font-size: small;">ARTICLE / FRISK depend of the order</td> <td colspan="2" style="font-size: small;">DIESEL: CONFORME A LA NORME D'INSTALLATION EN ALUMINIUM (A-H) - TOLERANCE DIN EN 50143 (A-H) - DIESEL AND METAL (A-H) (A-H)</td> <td colspan="2" style="text-align: center;"> 8. STAHL HMI Systeme GmbH Industrie - Germany www.stahlhmi.de</td> <td style="font-size: small;">Code</td> <td style="font-size: small;">Date</td> <td style="font-size: small;">Drawn</td> <td style="font-size: small;">Checked</td> </tr> <tr> <td style="font-size: small;">No.</td> <td style="font-size: small;">Modification</td> <td style="font-size: small;">Date</td> <td style="font-size: small;">Drawn</td> <td style="font-size: small;">Checked</td> <td style="font-size: small;">Date</td> <td style="font-size: small;">N. height</td> <td style="font-size: small;">A. JUNG</td> <td style="font-size: small;">A. JUNG</td> <td style="font-size: small;">A. JUNG</td> </tr> <tr> <td>01</td> <td>Address for identification codes</td> <td>12.07.2016</td> <td>SL</td> <td>JA</td> <td></td> <td></td> <td></td> <td></td> <td></td> </tr> <tr> <td colspan="10" style="font-size: x-small;">DRAWING NO. TITLE 11100025 Rev.01 x6E Control Drawing</td> </tr> <tr> <td colspan="10" style="text-align: right; font-size: x-small;">SHEET 2 OF 3</td> </tr> </table>								ARTICLE / FRISK depend of the order		DIESEL: CONFORME A LA NORME D'INSTALLATION EN ALUMINIUM (A-H) - TOLERANCE DIN EN 50143 (A-H) - DIESEL AND METAL (A-H) (A-H)		8. STAHL HMI Systeme GmbH Industrie - Germany www.stahlhmi.de		Code	Date	Drawn	Checked	No.	Modification	Date	Drawn	Checked	Date	N. height	A. JUNG	A. JUNG	A. JUNG	01	Address for identification codes	12.07.2016	SL	JA						DRAWING NO. TITLE 11100025 Rev.01 x6E Control Drawing										SHEET 2 OF 3									
ARTICLE / FRISK depend of the order		DIESEL: CONFORME A LA NORME D'INSTALLATION EN ALUMINIUM (A-H) - TOLERANCE DIN EN 50143 (A-H) - DIESEL AND METAL (A-H) (A-H)		8. STAHL HMI Systeme GmbH Industrie - Germany www.stahlhmi.de		Code	Date	Drawn	Checked																																																
No.	Modification	Date	Drawn	Checked	Date	N. height	A. JUNG	A. JUNG	A. JUNG																																																
01	Address for identification codes	12.07.2016	SL	JA																																																					
DRAWING NO. TITLE 11100025 Rev.01 x6E Control Drawing																																																									
SHEET 2 OF 3																																																									

23.3 Installation Instructions Requirements China

安装使用要求

Installation Instructions Requirements



认证编号
Certification No. CN2020C2309-003905-2

本产品经认证符合 CNCA-C23-01: 2019 《强制性产品认证实施规则 防爆电气》的要求。

The product(s) is verified and certified according to CNCA-C23-01: 2019 China Compulsory Certification Implementation Rule on Explosion Protected Electrical Product.

#	产品名称 Product 型号 Type	防爆标志 Ex Marking
1	防爆人机界面 (操作屏) xx-*x8-xxxxxx*	Ex eb q [ia op is Ga] IIC T4 Gb Ex tb [ia op is Da] IIIC T115°C Db Ex ec nR [ia op is Ga] IIC T4 Gc Ex tc [ia op is Da] IIIC T115°C Dc

依据标准 Series standards	GB/T3836.1-2021, GB/T3836.3-2021, GB/T3836.4-2021, GB/T3836.7-2017, GB/T3836.8-2021, GB/T3836.31-2021
安全使用条件 Specific conditions of safety use:	<ul style="list-style-type: none"> - 使用环境温度: -40°C ~ +70°C. - 本安电路接地; 沿本安电路, 必须有等电位连接。 - 用于带有无线接口的类型 (类型代码中W 02, W 05, W 22, W 55或W 25) : <p>IIC组连接到接口X36和X37的天线的最大射频功率阈值不得超过2 W的允许值, 此计算值应考虑到发射机的输出功率 (X36 / X37) , 天线增益和电缆损耗。</p> <p>X36和X37的本安电路接地。天线根据GB/T3836.15的要求安装接地。</p> <ul style="list-style-type: none"> - 连接腔的盖子配有已取得CCC认证的电缆引入装置和堵头, 可以选配插头、插座和开关, 这些产品需分别获得相应的认证并达到IP66防护等级。 - HMI系列xx-*x8-xxxxxx*可以通过xx-*x8-xxxxxx*安装框架安装在附加外壳中, 该套件被允许安装在Ex e、Ex p或Ex t外壳中。 - 本产品认证不包括对光辐射“op is”标准的评价和试验。 - The ambient temperature range is limited to -40°C up to +70°C. - The intrinsically safe circuits are connected to earth. Along the intrinsically safe circuits, potential equalization must exist.

	<ul style="list-style-type: none"> - For variants with wireless interface (characters W 02, W 05, W 22, W 55 or W 25 in type code): The maximum radio frequency power threshold at the antennas connected to the interfaces X36 and X37 shall not exceed the admissible value of 2 W for Group IIC. The calculation of this should take into account the output power of the transmitter (X36 / X37), the gain of the antenna and the losses in the cable. The intrinsically safe circuits at X36 und X37 are connected to earth. The antennas connected to the interface must be installed in accordance with earthing requirements of GB/T3836.15. The covers of the connection compartments are equipped with CCC certified cable glands and blind plugs. Optionally they can be equipped with CCC certified plugs and sockets and switches. This equipment has to fulfill IP66 and be separately certified for the respective type of protection. - The xx-*x8-xxxxxx* can be mounted in an additional enclosure with a suitable cut out via a xx-*x8-xxxxxx* mounting frame kit which is approved for mounting in an Ex e, Ex p or Ex t enclosure. - The evaluation and test of the optical radiation "op is" standard are not included in the scope of this product certification.
--	--

R. STAHL HMI Systems GmbH

产品上的符合性标志:

Compliance marks on product:



中国强制性认证
China Compulsory Certification
CCC: 2020312309000286

德国制造 Made in Germany
Doc No.: 20141870000
Approved: Date :

24 Attachment H

24.1 Declarations of EC conformity

24.1.1 EU

24.1.1.1 ET-xx8

EU-Konformitätserklärung EU Declaration of Conformity Déclaration de Conformité UE



R. STAHL HMI Systems GmbH • Adolf-Grimme-Allee 8 • 50829 Köln, Germany

erklärt in alleiniger Verantwortung, declares in its sole responsibility, déclare sous sa seule responsabilité,

dass das Produkt:

that the product:

que le produit:

Bedien- und Beobachtungsgeräte

Operating and Monitoring Devices

Consoles de commande et de visualisation

Typ(en), type(s), type(s):

ET-438-..., ET-538-..., ET-638-..., ET-738-...

ET-498-..., ET-598-..., ET-698-..., ET-798-...

mit den Anforderungen der folgenden Richtlinien und Normen übereinstimmt.

is in conformity with the requirements of the following directives and standards.

est conforme aux exigences des directives et des normes suivantes.

Richtlinie(n) / Directive(s) / Directive(s)	Norm(en) / Standard(s) / Norme(s)
2014/34/EU ATEX-Richtlinie	EN 60079-0:2012 + A11:2013 Das Produkt entspricht Anforderungen aus:
2014/34/EU ATEX Directive	EN 60079-5:2015
2014/34/UE Directive ATEX	EN 60079-7:2015 Product corresponds to requirements from:
	EN 60079-11:2012
	EN 60079-28:2015
	EN 60079-31:2014
	Produit correspond aux exigences: EN IEC 60079-0:2018 EN IEC 60079-7:2015 + A1:2018

Kennzeichnung, marking, marquage:

II 2(1) G Ex eb q [ia op is Ga] IIC T4 Gb **CE0158**
II 2(1) D Ex tb [ia op is Da] IIC T115°C Db

EU-Baumusterprüfbescheinigung:

EU Type Examination Certificate:

Attestation d'examen UE de type:

BVS 14 ATEX E 134 X

(DEKRA EXAM GmbH

Dinnendahlstraße 9, 44809 Bochum, Germany, NB0158)

2014/30/EU EMV-Richtlinie	EN 61000-6-2:2005 + AC:2005
2014/30/EU EMC Directive	EN 61000-6-4:2007 + A1:2011
2014/30/UE Directive CEM	
2014/53/EU Funkanlagen-Richtlinie	ETSI EN 300 328 V2.2.2 (2019-07)
2014/53/EU Radio Equipment Directive	
2014/53/UE Directive Equipement Radioélectrique	
Produktnormen nach Niederspannungsrichtlinie: Product standards according to Low Voltage Directive: Normes des produit pour la Directive Basse Tension:	DIN EN 62368-1:2016, IEC 62368-1:2014 (Second Edition)
Produktnormen nach RoHS-Richtlinie (2011/65/EU): Product standards according to RoHS Directive: Normes des produit pour la Directive RoHS:	EN IEC 63000:2018

Für spezifische Merkmale und Bedingungen siehe Betriebsanleitung.

For specific characteristics and conditions see operating instructions.

Pour les caractéristiques et conditions spécifiques, voir le mode d'emploi.

Köln, 2022-05-19

i.V.

A. Jung
Director R&D

i.V.

N. Benighil
Head of Certification

Ort und Datum
Place and date
Lieu et date

24.1.1.2 MT-xx8

EU-Konformitätserklärung
EU Declaration of Conformity
Déclaration de Conformité UE



R. STAHL HMI Systems GmbH • Adolf-Grimme-Allee 8 • 50829 Köln, Germany
 erklärt in alleiniger Verantwortung, *declares in its sole responsibility, déclare sous sa seule responsabilité,*

dass das Produkt: Bedien- und Beobachtungsgeräte
that the product: *Operating and Monitoring Devices*
que le produit: *Consoles de commande et de visualisation*

Typ(en), type(s), type(s): MT-438-..., MT-538-..., MT-638-..., MT-738-...
MT-498-..., MT-598-..., MT-698-..., MT-738-...

mit den Anforderungen der folgenden Richtlinien und Normen übereinstimmt.
is in conformity with the requirements of the following directives and standards.
est conforme aux exigences des directives et des normes suivantes.

Richtlinie(n) / Directive(s) / Directive(s)		Norm(en) / Standard(s) / Norme(s)	
2014/34/EU	ATEX-Richtlinie	EN 60079-0:2012 + A11:2013	Das Produkt entspricht Anforderungen aus: <i>Product corresponds to requirements from:</i> <i>Produit correspond aux exigences:</i> EN IEC 60079-0:2018 EN IEC 60079-7:2015 + A1:2018 DIN EN IEC 60079-15:2020
2014/34/EU	ATEX Directive	EN 60079-5:2015	
2014/34/UE	Directive ATEX	EN 60079-7:2015	
		EN 60079-11:2012	
		IEC 60079-15:2010	
		EN 60079-28:2015	
		EN 60079-31:2014	

Kennzeichnung, marking, marquage:
 II 3(1) G Ex ec nR [ja op is Ga] IIC T4 Gc
 II 3(1) D Ex tc [ja op is Da] IIIC T115°C Dc **CE0158**

EU-Baumusterprüfbescheinigung: **BVS 14 ATEX E 134 X**
EU Type Examination Certificate: *(DEKRA EXAM GmbH*
Attestation d'examen UE de type: *Dinnendahlstraße 9, 44809 Bochum, Germany, NB0158)*

2014/30/EU	EMV-Richtlinie	EN 61000-6-2:2005 + AC:2005
2014/30/EU	EMC Directive	EN 61000-6-4:2007 + A1:2011
2014/30/UE	Directive CEM	
2014/53/EU	Funkanlagen-Richtlinie	ETSI EN 300 328 V2.2.2 (2019-07)
2014/53/EU	Radio Equipment Directive	
2014/53/UE	Directive Équipement Radioélectrique	
Produktnormen nach Niederspannungsrichtlinie: <i>Product standards according to Low Voltage Directive:</i> <i>Normes des produit pour la Directive Basse Tension:</i>		DIN EN 62368-1:2016, IEC 62368-1:2014 (Second Edition)
Produktnormen nach RoHS-Richtlinie (2011/65/EU): <i>Product standards according to RoHS Directive:</i> <i>Normes des produit pour la Directive RoHS:</i>		EN IEC 63000:2018

Für spezifische Merkmale und Bedingungen siehe Betriebsanleitung.
For specific characteristics and conditions see operating instructions.
Pour les caractéristiques et conditions spécifiques, voir le mode d'emploi.

Köln, 2022-05-19 i.V. i.V.

Ort und Datum **A. Jung** **N. Benighil**
Place and date *Director R&D* *Head of Certification*
Lieu et date

24.1.2 RCM

Supplier's declaration of conformity



As required by the following Notices:

- > *Radiocommunications (Compliance Labelling - Devices) Notice 2014* made under section 182 of the *Radiocommunications Act 1992*;
- > *Radiocommunications Labelling (Electromagnetic Compatibility) Notice 2017* made under section 182 of the *Radiocommunications Act 1992*
- > *Radiocommunications (Compliance Labelling – Electromagnetic Radiation) Notice 2014* made under section 182 of the *Radiocommunications Act 1992* and
- > *Telecommunications (Labelling Notice for Customer Equipment and Customer Cabling) Instrument 2015* made under section 407 of the *Telecommunications Act 1997*.

Instructions for completion

- > *Do not return this form to the ACMA.* This completed form must be retained by the supplier as part of the documentation required for the compliance records and must be made available for inspection by the ACMA when requested.

Supplier's details (manufacturer, importer or authorised agent)

Company Name (OR INDIVIDUAL)

R. STAHL Australia Pty Ltd
TRADING AS R. STAHL HMI Systems GmbH

ACN/ARBN

ABN 81150955838

OR

New Zealand IRDN

--

Street Address (AUSTRALIAN or NEW ZEALAND)

848 Old Princes Highway
Sutherland, NSW
POSTCODE 2232
Phone: +61 2 4254 4777

Product details and date of manufacture

Product description – brand name, type, current model, lot, batch or serial number (if available), software/firmware version (if applicable)

Operating and Monitoring Devices ET-438-..., ET-538-..., ET-638-..., ET-738-..., ET-498-..., ET-598-..., ET-698-..., ET-798-...
Operating and Monitoring Devices MT-438-..., MT-538-..., MT-638-..., MT-738-..., MT-498-..., MT-598-..., MT-698-..., MT-738-...

Compliance – applicable standards and other supporting documents

Evidence of compliance with applicable standards may be demonstrated by test reports, endorsed/accredited test reports, certification/competent body statements.

Having had regard to these documents, I am satisfied the above mentioned product complies with the requirements of the relevant ACMA Standards made under the *Radiocommunications Act 1992* and the *Telecommunications Act 1997*.

List the details of the documents the above statement was made, including the standard title, number and, if applicable, number of the test report/endorsed test report or certification/competent body statement

EN 61000-6-4:2007 + A1:2011; EN 55032 (based on an ETSI EN 301 489-1 test report, referred to ACMA statement from 07.09.2018, Ref: CSC2018-27820, CRM:001214006281)

Declaration

I hereby declare that:

1. I am authorised to make this declaration on behalf of the Company mentioned above,
2. the contents of this form are true and correct, and
3. the product mentioned above complies with the applicable above mentioned standards and all products supplied under this declaration will be identical to the product identified above.

Note: Under section 137.1 of the *Criminal Code Act 1995*, it is an offence to knowingly provide false or misleading information to a Commonwealth entity.

Penalty: 12 months imprisonment

 SIGNATURE OF SUPPLIER OR AGENT	Managing Director POSITION IN ORGANISATION
John Zagame PRINT NAME	2018-10-15 DATE

The *Privacy Act 1988* (Cth) (the Privacy Act) imposes obligations on the ACMA in relation to the collection, security, quality, access, use and disclosure of personal information. These obligations are detailed in the Australian Privacy Principles.

The ACMA may only collect personal information if it is reasonably necessary for, or directly related to, one or more of the ACMA's functions or activities.

The purpose of collecting the personal information in this form is to ensure the supplier is identified in the 'Declaration of conformity'. If this Declaration of Conformity is not completed and the requested information is not provided, a compliance label cannot be applied.

Further information on the Privacy Act and the ACMA's Privacy Policy is available at www.acma.gov.au/privacypolicy. The Privacy Policy contains details about how you may access personal information about you that is held by the ACMA, and seek the correction of such information. It also explains how you may complain about a breach of the Privacy Act and how we will deal with such a complaint.

Should you have any questions in this regard, please contact the ACMA's privacy contact officer on telephone on 1800 226 667 or by email at privacy@acma.gov.au.

24.1.3 CCC

24.1.3.1 English version

		CERTIFICATE FOR CHINA COMPULSORY PRODUCT CERTIFICATION	
No.: 2020312309000286			
Applicant	R. STAHL HMI Systems GmbH	Address	Adolf-Grimme-Allee 8, 50829 Köln, Germany
Manufacturer	R. STAHL HMI Systems GmbH	Address	Adolf-Grimme-Allee 8, 50829 Köln, Germany
Production Factory	R. STAHL HMI Systems GmbH	Production Address	Adolf-Grimme-Allee 8, 50829 Köln, Germany
Product	Visualization and Control Unit		
Model/Type	xx-*x8-xxxxxx*		
Ex marking	Ex eb q [ia op is Ga] IIC T4 Gb, Ex tb [ia op is Da] IIIC T115°C Db Ex ec nR [ia op is Ga] IIC T4 Gc, Ex tc [ia op is Da] IIIC T115°C Dc		
Reference Standards	GB/T 3836.1-2021, GB/T 3836.3-2021, GB/T 3836.4-2021, GB/T 3836.7-2017, GB/T 3836.8-2021, GB/T 3836.31-2021		
Certification mode	Type Test + Initial Factory Inspection + Post-Certification Surveillance		
The product(s) is verified and certified according to CNCA-C23-01: 2019 <i>China Compulsory Certification Implementation Rule on Explosion Protected Electrical Product and CNEX-C2301-2019 Guideline of China Compulsory Certification Implementation Rule on Explosion Protected Electrical Product.</i>			
See Annex for the detailed product information (10 pages)			
Initial issue date: 2020-09-02			
Issued date: 2023-04-29		Valid to: 2025-09-01	
The validity of this certificate is maintained through the regular supervision of the issuing authority during the validity period.			
Where any discrepancy arises between the English translation and the original Chinese version, the Chinese version shall prevail.			
			Director: 
Nanyang Explosion Protected Electrical Apparatus Research Institute Co.,Ltd.		 中国认可 产品 PRODUCT CNAS C208-P	
http://www.ccc-cnex.com ccc.china-ex.com		Add: No. 20, North Zhongjing Road, Nanyang, Henan, P. R. China P.C.: 473008 Tel: 0377-63239734 Email: ccc@cn-ex.com	

CN 0001898



CERTIFICATE FOR CHINA COMPULSORY PRODUCT CERTIFICATION (Annex)

No.: 2020312309000286

Page 1 of 10

Product information:

1. This certificate covers the following models:

- xx-*x8-xxxxxx*

Subject and type:

The apparatus of xx-*x8-xxxxxx* are available in the following variants:

<u>xx</u>	-* <u>x8</u> -	<u>x</u>	<u>x</u>	<u>x</u>	<u>x</u>	<u>x</u>	<u>x</u> *
1	2	3	4	5	6	7	8

1	ET: Version with EPL Gb MT: Version with EPL Gc
2	3: Display size 1, 4: Display size 2, 5: Display size 2, 6: Display size 2, 7: Display size 2,8: Display size 3, 9: Display size 2
3	Optical interfaces (Ethernet) *TX: 10 / 100 / 1000 BaseTX copper interface, *FX: 100 BaseFX FO multimode *SX: 1000 BaseSX FO multimode, *LX: 1000 BaseLX FO single mode 00: Other interface
4	AC: AC power supply DC: DC power supply
5	Wireless interfaces W02: one 2.4 GHz interface, W05: one 5 GHz interface W22: two 2.4 GHz interfaces, W55: two 5 GHz interfaces W25: one 2.4 GHz and one 5 GHz interface W00: no Wireless interface
6	B1: Variant with Bluetooth B0: Variant without Bluetooth

Issued date: 2023-04-29

Director:



**Nanyang Explosion Protected Electrical
Apparatus Research Institute Co.,Ltd.**



http://www.ccc-cnex.com
ccc.china-ex.com

Add: No. 20, North Zhongjing Road, Nanyang, Henan, P. R. China P.C.: 473008
Tel: 0377-63239734 Email: ccc@cn-ex.com



CERTIFICATE FOR CHINA COMPULSORY PRODUCT CERTIFICATION (Annex)

No.: 2020312309000286

Page 2 of 10

7	RFID interfaces C1: RFID 13.56 MHz integrated, C2: RFID 2.4 GHz integrated C3: RFID 13.56 MHz MIFARE / DESFire / EV1, CRYPT C4: RFID 13.56 MHz MIFARE / DESFire / EV1, ASCII C5: RFID 13.56 MHz LEGIC, CRYPT C6: RFID 13.56 MHz LEGIC, ASCII C7: RFID 13.56 MHz NFC C0: no RFID integrated
8	Optical interface for the connection of an OptionBox XSX-OptionBox FO multimode interface XLX-OptionBox FO single mode interface X00-No OptionBox interface

Parameters:

- | | | |
|-----|--|----------------|
| 1 | Non-intrinsically safe circuits | |
| 1.1 | Terminal block X1
Non-intrinsically safe supply circuit (Power) | |
| | Nominal voltage | |
| | for type xx-*x8-xACxxxx* | AC 100...240 V |
| | for type xx-*x8-xDCxxxx* | DC 20... 30 V |
| | Nominal current | |
| | for type xx-*x8-xACxxxx* | ≤ 5 A |
| | for type xx-*x8-xDCxxxx* | ≤ 8 A |
| | Nominal power | ≤ 150 W |
| | Max. input voltage Um | AC 250 V |
| 1.2 | Terminal blocks X2 and X3
Non-intrinsically safe interfaces Copper1 (X2) and Copper2 (X3) | |
| | Nominal voltage | AC/DC 5 V |
| | Max. input voltage Um | AC 250 V |

Issued date: 2023-04-29

Director:



Nanyang Explosion Protected Electrical
Apparatus Research Institute Co.,Ltd.



http://www.ccc-cnex.com
ccc.china-ex.com

Add: No. 20, North Zhongjing Road, Nanyang, Henan, P. R. China
Tel: 0377-63239734

P.C.: 473008
Email: ccc@cn-ex.com



CERTIFICATE FOR CHINA COMPULSORY PRODUCT CERTIFICATION (Annex)

No.: 2020312309000286

Page 3 of 10

1.3	Terminal block X4 Non-intrinsically safe circuit DC out Nominal voltage X4, terminal 1 Nominal voltage X4, terminal 4 Max. input voltage Um	DC 12 V DC 24 V AC 250 V
1.4	Terminal block X5 Non-intrinsically safe CAN interface (E-Box) Nominal voltage Max. input voltage Um	AC/DC 5 V AC 250 V
1.5	Terminal block X6 Non-intrinsically safe USB interface (E-Box) Nominal voltage Max. input voltage Um	DC 5 V AC 250 V
1.6	Terminal block X7 Non-intrinsically safe RSxxx interface (E-Box) Nominal voltage Max. input voltage Um	AC/DC 12 V AC 250 V
1.7	Terminal block X8 Non-intrinsically safe DVI interface (E-Box) Nominal voltage Max. input voltage Um	AC/DC 5 V AC 250 V
1.8	Terminal block X9 Non-intrinsically safe Audio / Video interface (E-Box) Nominal voltage Max. input voltage Um	AC/DC 5 V AC 250 V
1.9	Terminal block X10 Non-intrinsically safe SATA interface (E-Box) Nominal voltage Max. input voltage Um	AC/DC 5 V AC 250 V

Issued date: 2023-04-29

Director:



**Nanyang Explosion Protected Electrical
Apparatus Research Institute Co.,Ltd.**



http://www.ccc-cnex.com
ccc.china-ex.com

Add: No. 20, North Zhongjing Road, Nanyang, Henan, P. R. China
Tel: 0377-63239734

P.C.: 473008
Email: ccc@cn-ex.com



CERTIFICATE FOR CHINA COMPULSORY PRODUCT CERTIFICATION (Annex)

No.: 2020312309000286

Page 4 of 10

- 2 Intrinsically safe circuits level of protection Ex ia IIC resp. Ex ia
- 2.1 Terminal block X30
for the connection of e.g. a Power Button
Intrinsically safe output PB (Power Button)
Terminals 1(+), 2/3/4(gnd)
- | | |
|------------------------------------|------------|
| Max. output voltage U_o | DC 5.36 V |
| Max. output current I_o | 46 mA |
| Linear output characteristics | |
| Max. output power P_o | 61 mW |
| Max. external capacitance C_o | 65 μ F |
| for max. external inductance L_o | 1 μ H |
| or | |
| Max. external capacitance C_o | 10 μ F |
| for max. external inductance L_o | 20 μ H |
- 2.2 Terminal block X31
for the connection of e.g. up to 2 fans
Intrinsically safe output circuits FAN
Terminals 1(+), 2(gnd) and 3(+), 4(gnd)
- for each circuit:
- | | |
|------------------------------------|-------------|
| Max. output voltage U_o | DC 15.75 V |
| Max. output current I_o | 189 mA |
| Trapezoidal output characteristics | |
| Max. output power P_o | 1.092 W |
| Max. external capacitance C_o | 290 nF |
| for max. external inductance L_o | 100 μ H |
| or | |
| Max. external capacitance C_o | 478 nF |
| for max. external inductance L_o | 20 μ H |
- 2.3 Terminal block X32
for the connection of e.g. a Barcode or Card reader

Issued date: 2023-04-29

Director:



Nanyang Explosion Protected Electrical
Apparatus Research Institute Co.,Ltd.



<http://www.ccc-cnex.com>
ccc.china-ex.com

Add: No. 20, North Zhongjing Road, Nanyang, Henan, P. R. China P.C.: 473008
Tel: 0377-63239734 Email: ccc@cn-ex.com



CERTIFICATE FOR CHINA COMPULSORY PRODUCT CERTIFICATION (Annex)

No.: 2020312309000286

Page 5 of 10

- 2.3.1 Intrinsically safe output circuit for the supply of the connected apparatus
The connected apparatus can be supplied either from the „10.4 V-supply circuit or from the“5.4 V”-supply circuit. The terminals 1 and 2 shall not be connected at the same time.

- 2.3.1.1 Intrinsically safe output circuit “10.4 V”

Terminals 1(+), 3(gnd)	
Max. output voltage U_o	DC 10.4 V
Max. output current I_o	391 mA
Trapezoidal output characteristics	
Max. output power P_o Max.	2.253 W
external capacitance C_o	2.52 μ F
for max. external inductance L_o	20 μ H
or	
Max. external capacitance C_o	1.2 μ F
for max. external inductance L_o	100 μ H

- 2.3.1.2 Intrinsically safe output circuit “5.4 V”

Terminals 2(+), 3(gnd)	
Max. output voltage U_o	DC 5.36 V
Max. output current I_o	420 mA
Trapezoidal output characteristics	
Max. output power P_o	1.213 W
Max. external capacitance C_o	65 μ F
for max. external inductance L_o	1 μ H
or	
Max. external capacitance C_o	45 μ F
max. external inductance L_o	2 μ H

- 2.3.2 Intrinsically safe data circuit

Terminals 4(TXD), 5(RXD), 3(gnd)	
Max. input voltage U_i	\pm 12.5 V
Effective internal capacitance C_i	negligible
Effective internal inductance L_i	negligible

Issued date: 2023-04-29

Director:



**Nanyang Explosion Protected Electrical
Apparatus Research Institute Co.,Ltd.**



http://www.ccc-cnex.com
ccc.china-ex.com

Add: No. 20, North Zhongjing Road, Nanyang, Henan, P. R. China
Tel: 0377-63239734

P.C.: 473008
Email: ccc@cn-ex.com



CERTIFICATE FOR CHINA COMPULSORY PRODUCT CERTIFICATION (Annex)

No.: 2020312309000286

Page 6 of 10

Max. output voltage U_o	DC ± 5.35 V
RXD-gnd resp. TXD-gnd	DC ± 10.7 V
RXD-TXD	± 16 mA
Max. output current I_o	
Linear output characteristics	
Max. output power P_o	22 mW
Max. external capacitance C_o	2.23 μ F
for max. external inductance L_o	1 μ H
or	
Max. external capacitance C_o	2.23 μ F
for max. external inductance L_o	20 μ H

Note:

The external capacitances and inductances were calculated for the maximum voltage of 10.7 V.

If only one of the two signals RXD or TXD is connected, only a reduced voltage of 5.35 V has to be considered. Therewith, the following values are permissible:

Max. external capacitance C_o	65 μ F
for max. external inductance L_o	1 μ H
or	
Max. external capacitance C_o	45 μ F
for max. external inductance L_o	2 μ H

- 2.4 Terminal blocks X33 and X34
for the connection of e.g. a Keyboard (X33) resp. a Mouse (X34)
Terminals 1(+), 2(D-), (D+), 4(gnd)
For each terminal block:
- | | |
|------------------------------------|--------------|
| Max. output voltage U_o | DC 5.36 V |
| Max. output current I_o | 249.85 mA |
| Max. output power P_o | 518 mW |
| Max. external capacitance C_o | 65 μ F |
| for max. external inductance L_o | 0.68 μ H |
| or | |
| Max. external capacitance C_o | 46 μ F |
| for max. external inductance L_o | 1.68 μ H |

Issued date: 2023-04-29

Director:



Nanyang Explosion Protected Electrical
Apparatus Research Institute Co.,Ltd.



<http://www.ccc-cnex.com>
ccc.china-ex.com

Add: No. 20, North Zhongjing Road, Nanyang, Henan, P. R. China P.C.: 473008
Tel: 0377-63239734 Email: ccc@cn-ex.com



CERTIFICATE FOR CHINA COMPULSORY PRODUCT CERTIFICATION
(Annex)

No.: 2020312309000286

Page 7 of 10

or	
Max. external capacitance Co	32 µF
for max. external inductance Lo	2.68 µH
or	
Max. external capacitance Co	25 µF
for max. external inductance Lo	3.68 µH
or	
Max. external capacitance Co	21 µF
for max. external inductance Lo	4.68 µH
2.5	Terminal block/USB-socket X35
	for the connection of e.g. an USB-Memory Stick
	The connection can be done via terminal block X351 or USB-socket X352.
	Terminals 1(+), 2(D-), 3(D+), 4(gnd)
	Max. output voltage Uo
	DC 5.36 V
	Max. output current Io
	1.264 A
	Max. output power Po
	2.949 W
	Max. external capacitance Co
	65 µF
	for max. external inductance Lo
	0.68 µH
	or
	Max. external capacitance Co
	44 µF
	for max. external inductance Lo
	1.68 µH
	or
	Max. external capacitance Co
	30 µF
	for max. external inductance Lo
	2.68 µH
	or
	Max. external capacitance Co
	23 µF
	for max. external inductance Lo
	3.68 µH
	or
	Max. external capacitance Co
	19 µF
	for max. external inductance Lo
	4.68 µH
2.6	Sockets X36 (RF1), X37 (RF2)
	to be connected to an external antenna
	Radio frequency
	2.4 resp. 5 GHz

Issued date: 2023-04-29

Director:



Nanyang Explosion Protected Electrical
Apparatus Research Institute Co.,Ltd.



<http://www.ccc-cnex.com>
ccc.china-ex.com

Add: No. 20, North Zhongjing Road, Nanyang, Henan, P. R. China P.C.: 473008
Tel: 0377-63239734 Email: ccc@cn-ex.com



CERTIFICATE FOR CHINA COMPULSORY PRODUCT CERTIFICATION (Annex)

No.: 2020312309000286

Page 8 of 10

The radio frequency depends on the type (characters W02, W05, W22, W55, W25 resp. W00 in type code, see clause 1).

Effective radio frequency power of the used transmitter 17 dBm
resp. 50 mW

The maximum radio frequency power of the antenna is calculated as product of the effective radio frequency power of the transmitter and the antenna gain of the used antenna (losses of the cable between X36 resp. X37 and antenna may be considered). The maximum radio frequency power shall not exceed the maximum permissible radio frequency power 2 W for Group IIC.

3 Fiber optic interfaces:

X20 / X21: Fiber 1 / Fiber 2 for HMI series type xx-*x8-FXxxxx*:

Wavelength 1310 nm
Nominal optical radiated power 0.344 mW
Max. optical radiated power under fault conditions 35 mW

X20 / X21: Fiber 1 / Fiber 2 for HMI series type xx-*x8-SXxxxx*:

Wavelength 850 nm
Nominal optical radiated power 0.22 mW
Max. optical radiated power under fault conditions 35 mW

X20 / X21: Fiber 1 / Fiber 2 for HMI series type xx-*x8-LXxxxx*:

Wavelength 1310 nm
Nominal optical radiated power 0.22 mW
Max. optical radiated power under fault conditions 35 mW

X22: Fiber 3 for HMI series type xx-*x8-xxxxXSX*:

Wavelength 850 nm
Nominal optical radiated power 0.22 mW
Max. optical radiated power under fault conditions 35 mW

X22: Fiber 3 for HMI series type xx-*x8-xxxxXLX*:

Wavelength 1310 nm
Nominal optical radiated power 0.22 mW

Issued date: 2023-04-29

Director:



Nanyang Explosion Protected Electrical
Apparatus Research Institute Co.,Ltd.



<http://www.ccc-cnex.com>
ccc.china-ex.com

Add: No. 20, North Zhongjing Road, Nanyang, Henan, P. R. China P.C.: 473008
Tel: 0377-63239734 Email: ccc@cn-ex.com



CERTIFICATE FOR CHINA COMPULSORY PRODUCT CERTIFICATION (Annex)

No.: 2020312309000286

Page 9 of 10

Max. optical radiated power under fault conditions

35 mW

Ex marking:

ET-*x8-xxxxx*: Ex eb q [ia op is Ga] IIC T4 Gb, Ex tb [ia op is Da] IIIC T115°C Db

MT-*x8-xxxxx*: Ex ec nR [ia op is Ga] IIC T4 Gc, Ex tc [ia op is Da] IIIC T115°C Dc

- Producers should organize production in accordance with the technical documents approved by the certification body.

2. Specific conditions of safety use:

- The ambient temperature range is limited to -40°C up to +70°C.
- The intrinsically safe circuits are connected to earth. Along the intrinsically safe circuits, potential equalization must exist.
- For variants with wireless interface (characters W 02, W 05, W 22, W 55 or W 25 in type code):
The maximum radio frequency power threshold at the antennas connected to the interfaces X36 and X37 shall not exceed the admissible value of 2 W for Group IIC. The calculation of this should take into account the output power of the transmitter (X36 / X37), the gain of the antenna and the losses in the cable.
The intrinsically safe circuits at X36 und X37 are connected to earth. The antennas connected to the interface must be installed in accordance with earthing requirements of GB/T3836.15.
- The covers of the connection compartments are equipped with CCC certified cable glands and blind plugs.

Optionally they can be equipped with CCC certified plugs and sockets and switches. This equipment has to fulfill IP66 and be separately certified for the respective type of protection.
- The xx-*x8-xxxxx* can be mounted in an additional enclosure with a suitable cut out via a xx-*x8-xxxxx* mounting frame kit which is approved for mounting in an Ex e, Ex p or Ex t enclosure.

Issued date: 2023-04-29

Director:



Nanyang Explosion Protected Electrical
Apparatus Research Institute Co.,Ltd.



http://www.ccc-cnex.com
ccc.china-ex.com

Add: No. 20, North Zhongjing Road, Nanyang, Henan, P. R. China P.C.: 473008
Tel: 0377-63239734 Email: ccc@cn-ex.com



CERTIFICATE FOR CHINA COMPULSORY PRODUCT CERTIFICATION (Annex)

No.: 2020312309000286

Page 10 of 10

- The evaluation and test of the optical radiation "op is" standard are not included in the scope of this product certification.
- See instruction for other information.
- 3. Certificate related report(s):
 - Type test report: CQST2005C020R, CQST2005C020R/01
 - Factory inspection report: CN2023Q030119.
- 4. Certificate change information:
 - The changing of Model/Type of the product is as first change on February 25, 2021.
 - 2nd change on April 29, 2023: Updated the standards for certification.

Issued date: 2023-04-29

Director:



Nanyang Explosion Protected Electrical
Apparatus Research Institute Co.,Ltd.



<http://www.ccc-cnex.com>
ccc.china-ex.com

Add: No. 20, North Zhongjing Road, Nanyang, Henan, P. R. China P.C.: 473008
Tel: 0377-63239734 Email: ccc@cn-ex.com

24.1.3.2 Chinese version



中国国家强制性产品认证证书

编 号: 2020312309000286

委 托 人	R. STAHL HMI Systems GmbH
地 址	Adolf-Grimme-Allee 8, 50829 Köln, Germany
生 产 者	R. STAHL HMI Systems GmbH
地 址	Adolf-Grimme-Allee 8, 50829 Köln, Germany
生 产 企 业	R. STAHL HMI Systems GmbH
生 产 地 址	Adolf-Grimme-Allee 8, 50829 Köln, Germany
产 品 名 称	防爆人机界面 (操作屏)
型 号 规 格	xx-*x8-xxxxxx*
防 爆 标 志	Ex eb q [ia op is Ga] IIC T4 Gb, Ex tb [ia op is Da] IIIC T115°C Db Ex ec nR [ia op is Ga] IIC T4 Gc, Ex tc [ia op is Da] IIIC T115°C Dc
依 据 标 准	GB/T 3836.1-2021, GB/T 3836.3-2021, GB/T 3836.4-2021, GB/T 3836.7-2017, GB/T 3836.8-2021, GB/T 3836.31-2021

认 证 模 式 型式试验+初始工厂检查+获证后监督

上述产品符合 CNCA-C23-01: 2019《强制性产品认证实施规则 防爆电气》
和 CNEX-C2301-2019《强制性产品认证实施细则 防爆电气》的要求。

产品相关信息见附页 (共 10 页)。

首次发证日期: 2020 年 09 月 02 日

颁发日期: 2023 年 04 月 29 日

有效期至: 2025 年 09 月 01 日

证书有效期内本证书的有效性依据发证机构的定期监督获得保持。

主任:



南阳防爆电气研究所有限公司



网址: www.ccc-cnex.com
ccc.china-ex.com

地址: 中国河南省南阳市仲景北路20号
电话: 0377-63239734

邮政编码: 473008
邮箱: ccc@cn-ex.com

CN 0025794



中国国家强制性产品认证证书 (附页)

编 号: 2020312309000286

第 1 页 共 10 页

产品相关信息:

1、本证书覆盖产品如下:

- xx-*x8-xxxxxx*

型号含义如下:

xx -*x8- x x x x x x*

1 2 3 4 5 6 7 8

1	ET: Gb MT: Gc
2	3: 显示屏尺寸1, 4: 显示屏尺寸2, 5: 显示屏尺寸2, 6: 显示屏尺寸2, 7: 显示屏尺寸28: 显示屏尺寸3, 9: 显示屏尺寸2
3	光纤接口(以太网) *TX: 10/100/1000 BaseTX 铜缆接口 *FX: 100 BaseFX FO 光口, 多模光纤 *SX: 1000 BaseSX FO 光口, 多模光纤 *LX: 1000 BaseLX FO 光口, 单模光纤 00: 其他接口
4	AC: 交流电源供电 DC: 直流电源供电
5	无线接口 W02: 1个2.4 GHz 接口, W05: 1个5 GHz 接口 W22: 2个2.4 GHz 接口, W55: 2个5 GHz 接口

颁发日期: 2023 年 04 月 29 日

主任:



南阳防爆电气研究所有限公司



网址: www.ccc-cnex.com
ccc.china-ex.com

地址: 中国河南省南阳市仲景北路20号
电话: 0377-63239734

邮政编码: 473008
邮箱: ccc@cn-ex.com



中国国家强制性产品认证证书 (附页)

编 号: 2020312309000286

第 2 页 共 10 页

	W25: 1个2.4 GHz 和1个5 GHz 接口 W00: 无线接口
6	B1: 带蓝牙接口 B0: 无蓝牙接口
7	RFID 接口 C1: 集成 13.56 MHz RFID 接口 C2:集成 2.4 GHz RFID 接口 C3: RFID 13.56 MHz MIFARE / DESFire / EV1,加密 C4: RFID 13.56 MHz MIFARE / DESFire / EV1, ASCII C5: RFID 13.56 MHz LEGIC, 加密 C6: RFID 13.56 MHz LEGIC, ASCII C7: RFID 13.56 MHz NFC C0:无 RFID 接口
8	可选配光纤盒 XSX-OptionBox FO 多模光纤接口 XLX-OptionBox FO 单模光纤接口 X00-无光纤盒

颁发日期: 2023 年 04 月 29 日

主任:



南阳防爆电气研究所有限公司



网址: www.ccc-cnex.com
ccc.china-ex.com

地址: 中国河南省南阳市仲景北路20号
电话: 0377-63239734

邮政编码: 473008
邮箱: ccc@cn-ex.com



中国国家强制性产品认证证书 (附页)

编 号: 2020312309000286

第 3 页 共 10 页

电气参数:

非本安电路

- 1) 接线端子 X1
非本安电路 (电源)
标称电压
xx-*x8-xACxxxx* AC 100-240V
xx-*x8-xDCxxxx* DC 20-30V
标称电流
xx-*x8-xACxxxx* ≤5A
xx-*x8-xDCxxxx* ≤8A
标称功率 ≤150W
最高输入电压 Um AC 250V
- 2) 接线端子 X2、X3
非本安铜缆接口 1 (X2) 和 铜缆接口 2 (X3)
标称电压 AC/DC 5V
最高输入电压 Um AC 250V
- 3) 接线端子 X4
非本安电路直流输出
标称电压 X4, 端子 1 DC 12V
标称电压 X4, 端子 4 DC 24V
最高输入电压 Um AC 250V
- 4) 接线端子 X5
非本安接口 CAN (E-BOX)
标称电压 AC/DC 5V
最高输入电压 Um AC 250V
- 5) 接线端子 X6
非本安接口 USB (E-BOX)
标称电压 AC/DC 5V
最高输入电压 Um AC 250V

颁发日期: 2023 年 04 月 29 日

主任: 穆大玉



南阳防爆电气研究所有限公司



网址: www.ccc-cnex.com
ccc.china-ex.com

地址: 中国河南省南阳市仲景北路20号
电话: 0377-63239734

邮政编码: 473008
邮箱: ccc@cn-ex.com



中国国家强制性产品认证证书 (附页)

编 号: 2020312309000286

第 4 页 共 10 页

- 6) 接线端子 X7
非本安接口 RSxxx (E-BOX)
标称电压 AC/DC 12V
最高输入电压 U_m AC 250V
- 7) 接线端子 X8
非本安接口 DVI (E-BOX)
标称电压 AC/DC 5V
最高输入电压 U_m AC 250V
- 8) 接线端子 X9
非本安接口音视频 (E-BOX)
标称电压 AC/DC 5V
最高输入电压 U_m AC 250V
- 9) 接线端子 X10
非本安接口 SATA (E-BOX)
标称电压 AC/DC 5V
最高输入电压 U_m AC 250V

本安电路 保护级别 Ex ia IIC

- 1) 接线端子 X30
用于连接 电源按钮
本安输出电源按钮
端子 1 (+), 2/3/4 (gnd)
最大输出电压 U_o DC 5.36V
最大输出电流 I_o 46mA
线性输出特性
最大输出功率 P_o 61mW
最大外部电容 C_o 65 μ F
最大外部电感 L_o 1 μ H
或

颁发日期: 2023 年 04 月 29 日

主任:

穆大玉



南阳防爆电气研究所有限公司



中国认可
产品
PRODUCT
CNAS C208-P

网址: www.ccc-cnex.com
ccc.china-ex.com

地址: 中国河南省南阳市仲景北路20号
电话: 0377-63239734

邮政编码: 473008
邮箱: ccc@cn-ex.com



中国国家强制性产品认证证书 (附页)

编 号: 2020312309000286

第 5 页 共 10 页

最大外部电容	C _o	10μF
最大外部电感	L _o	20μH

2) 接线端子 X31

用于连接最多 2 个风扇

本安电路输出 风扇

端子 1 (+), 2 (gnd) 和 3 (+), 4 (gnd)

对于每个回路

最大输出电压	U _o	DC 15.75V
--------	----------------	-----------

最大输出电流	I _o	189mA
--------	----------------	-------

梯形输出特性

最大输出功率	P _o	1.092W
--------	----------------	--------

最大外部电容	C _o	290nF
--------	----------------	-------

最大外部电感	L _o	100μH
--------	----------------	-------

或

最大外部电容	C _o	478nF
--------	----------------	-------

最大外部电感	L _o	20μH
--------	----------------	------

3) 接线端子 X32

用于连接条形码或读卡器。

(1) 用于连接设备供电的本安输出电路

可以通过“10.4 V”电源电路或“5.4 V”电源电路为连接的设备供电。端子 1 和 2 不能同时连接。

① 本安输出电路 10.4V

端子 1 (+), 3 (gnd)

最大输出电压	U _o	DC 10.4V
--------	----------------	----------

最大输出电流	I _o	391mA
--------	----------------	-------

梯形输出特性

最大输出功率	P _o	2.253W
--------	----------------	--------

最大外部电容	C _o	2.52μF
--------	----------------	--------

最大外部电感	L _o	20μH
--------	----------------	------

或

最大外部电容	C _o	1.2μF
--------	----------------	-------

颁发日期: 2023 年 04 月 29 日

主任:

穆大玉



南阳防爆电气研究所有限公司



中国认可
产品
PRODUCT
CNAS C208-P

网址: www.ccc-cnex.com
ccc.china-ex.com

地址: 中国河南省南阳市仲景北路20号
电话: 0377-63239734

邮政编码: 473008
邮箱: ccc@cn-ex.com



中国国家强制性产品认证证书 (附页)

编 号: 2020312309000286

第 6 页 共 10 页

最大外部电感	L_o	100 μ H
② 本安输出电路 5.4V 端子 2 (+), 3 (gnd)		
最大输出电压	U_o	DC 5.36V
最大输出电流	I_o	420mA
梯形输出特性		
最大输出功率	P_o	1.213W
最大外部电容	C_o	65 μ F
最大外部电感	L_o	1 μ H
或		
最大外部电容	C_o	45 μ F
最大外部电感	L_o	2 μ H
(2) 本安数据电路 端子 4 (TXD), 5 (RXD), 3 (gnd)		
最大输出电压	U_i	± 12.5 V
有效内部电容	C_i	可忽略
有效内部电感	L_i	可忽略
最大输出电压	U_o	
RXD-gnd、TXD-gnd		DC ± 5.35 V
RXD-TXD		DC ± 10.7 V
最大输出电流	I_o	± 16 mA
线性输出特性		
最大输出功率	P_o	22mW
最大外部电容	C_o	2.23 μ F
最大外部电感	L_o	1 μ H
或		
最大外部电容	C_o	2.23 μ F
最大外部电感	L_o	20 μ H

最大电压为 10.7 V 时的外部电容和电感是计算出的。
如果仅连接两个信号 RXD 或 TXD 之一, 则仅需考虑降低电压 5.35V。因此, 以下值是允许的

颁发日期: 2023 年 04 月 29 日

主任:



南阳防爆电气研究所有限公司



网址: www.ccc-cnex.com
ccc.china-ex.com

地址: 中国河南省南阳市仲景北路20号
电话: 0377-63239734

邮政编码: 473008
邮箱: ccc@cn-ex.com



中国国家强制性产品认证证书 (附页)

编 号: 2020312309000286

第 7 页 共 10 页

最大外部电容	C _o	65μF
最大外部电感	L _o	1μH
或		
最大外部电容	C _o	45μF
最大外部电感	L _o	2μH

4) 接线端子 X33、X34

用于连接 键盘 (X33) 或 鼠标 (X34)
Terminals 1(+), 2(D-), (D+), 4(gnd)

对于每个端子

最大输出电压	U _o	DC 5.36V
最大输出电流	I _o	249.85mA
最大输出功率	P _o	518mW
最大外部电容	C _o	65μF
最大外部电感	L _o	0.68μH

或

最大外部电容	C _o	46μF
最大外部电感	L _o	1.68μH

或

最大外部电容	C _o	32μF
最大外部电感	L _o	2.68μH

或

最大外部电容	C _o	25μF
最大外部电感	L _o	3.68μH

或

最大外部电容	C _o	21μF
最大外部电感	L _o	4.68μH

5) 接线盒/ USB 插座 X35

用于连接 USB 记忆棒

可以通过端子排 X351 或 USB 插座 X352 进行连接
Terminals 1(+), 2(D-), 3(D+), 4(gnd)

最大输出电压	U _o	DC5.36V
最大输出电流	I _o	1.264A

颁发日期: 2023 年 04 月 29 日

主任:



南阳防爆电气研究所有限公司



中国认可
产品
PRODUCT
CNAS C208-P

网址: www.ccc-cnex.com
ccc.china-ex.com

地址: 中国河南省南阳市仲景北路20号
电话: 0377-63239734

邮政编码: 473008
邮箱: ccc@cn-ex.com



中国国家强制性产品认证证书 (附页)

编 号: 2020312309000286

第 8 页 共 10 页

最大输出功率	P _o	2.949W
最大外部电容	C _o	65μF
最大外部电感	L _o	0.68μH
或		
最大外部电容	C _o	44μF
最大外部电感	L _o	1.68μH
或		
最大外部电容	C _o	30μF
最大外部电感	L _o	2.68μH
或		
最大外部电容	C _o	23μF
最大外部电感	L _o	3.68μH
或		
最大外部电容	C _o	19μF
最大外部电感	L _o	4.68μH

6) 插座 X36 (RF1) , X37 (RF2)

连接到外部天线

无线电频率

2.4, 5 GHz

无线电频率取决于类型 (类型代码中的字符 W02, W05, W22, W55, W25 和 W00)

所使用的发射机的有效射频功率为 17 dBm/50mW

最大射频功率通过计算作为变送器的有效射频功率和所用天线的天线增益 (考虑 X36 或 X37 与天线之间的电缆损耗)

最大射频功率不得超过 IIC 组最大允许射频功率 2 W

光纤接口

X20 / X21: HMI 系列 xx-*x8-FXxxxx*的光纤 1/光纤 2:

波长

1310 nm

标称光辐射功率

0.344 mW

故障状况下最大的的光辐射功率

35 mW

颁发日期: 2023 年 04 月 29 日

主任: 穆大玉



南阳防爆电气研究所有限公司



中国认可
产品
PRODUCT
CNAS C208-P

网址: www.ccc-cnex.com
ccc.china-ex.com

地址: 中国河南省南阳市仲景北路20号
电话: 0377-63239734

邮政编码: 473008
邮箱: ccc@cn-ex.com



中国国家强制性产品认证证书 (附页)

编 号：2020312309000286

第 9 页 共 10 页

X20 / X21: HMI 系列 xx-*x8-SXxxxxx*的光纤 1 /光纤 2:

波长	850nm
标称光辐射功率	0.22 mW
故障状况下最大的的光辐射功率	35 mW

X20 / X21: HMI 系列 xx-*x8-LXxxxxx*的光纤 1 /光纤 2:

波长	1310 nm
标称光辐射功率	0.22 mW

故障状况下最大的的光辐射功率 35 mW

X22: HMI 系列 xx-*x8-xxxxxXSX*的光纤 3:

波长	850 nm
标称光辐射功率	0.22 mW
故障状况下最大的的光辐射功率	35 mW

X22: HMI 系列 xx-*x8-xxxxxXLX*的光纤 3:

波长	1310 nm
标称光辐射功率	0.22 mW
故障状况下最大的的光辐射功率	35 mW

防爆标志:

ET-*x8-xxxxxx*: Ex eb q [ia op is Ga] IIC T4 Gb, Ex tb [ia op is Da] IIIC T115°C Db

MT-*x8-xxxxxx*: Ex ec nR [ia op is Ga] IIC T4 Gc, Ex tc [ia op is Da] IIIC T115°C Dc

- 生产者应按照认证机构批准的技术文件组织生产。

2、安全使用条件:

- 使用环境温度: -40°C ~ +70°C。
- 本安电路接地; 沿本安电路, 必须有等电位连接。

颁发日期: 2023 年 04 月 29 日

主任: 穆大玉



南阳防爆电气研究所有限公司



网址: www.ccc-cnex.com
ccc.china-ex.com

地址: 中国河南省南阳市仲景北路20号
电话: 0377-63239734

邮政编码: 473008
邮箱: ccc@cn-ex.com



中国国家强制性产品认证证书 (附页)

编 号：2020312309000286

第 10 页 共 10 页

- 用于带有无线接口的类型 (类型代码中 W 02, W 05, W 22, W 55 或 W 25) :

IIC 组连接到接口 X36 和 X37 的天线的最大射频功率阈值不得超过 2 W 的允许值, 此计算值应考虑到发射机的输出功率 (X36 / X37), 天线增益和电缆损耗。

X36 和 X37 的本安电路接地。天线根据 GB/T3836.15 的要求安装接地。

- 连接腔的盖子配有已取得 CCC 认证的电缆引入装置和堵头, 可以选配插头、插座和开关, 这些产品需分别获得相应的认证并达到 IP66 防护等级。

- HMI 系列 xx-*x8-xxxxxx*可以通过 xx-*x8-xxxxxx*安装框架安装在附加外壳中, 该套件被允许安装在 Ex e、Ex p 或 Ex t 外壳中。

- 本产品认证不包括对光辐射 "op is" 标准的评价和试验。

- 其他见产品使用说明书。

3、证书关联报告:

- 产品型式试验报告: CQST2005C020R, CQST2005C020R/01

- 工厂检查报告: CN2023Q030119

4、证书变更信息:

- 2021 年 02 月 25 日第 1 次变更, 变更内容为型号规格。

- 2023 年 04 月 29 日第 2 次变更: 产品认证依据标准变更。

颁发日期: 2023 年 04 月 29 日

主任:



南阳防爆电气研究所有限公司



网址: www.ccc-cnex.com
ccc.china-ex.com

地址: 中国河南省南阳市仲景北路20号
电话: 0377-63239734

邮政编码: 473008
邮箱: ccc@cn-ex.com

25 Appendix I

25.1 Release notes

The chapter entitled "Release Notes" contains all the changes made in every version of the Operating Instructions.

Version 01.02.05

- Removal of older release notes
- Renew EU declaration of conformity
- Correction of phone and fax no.
- Addition of the "TC" field function in certificates
- Changing from DNV / GL -> into DNV
- Addition of BIS certification for ET-4x8 and ET-5x8 devices
- Correction of certification designation KGS for Korea -> into KCS
- Changing Radio equipment directive
- Changing CNEX certification
- Changing in "Technical Data": AMD only with WIN 10 LTSB 2016 and i5 only with TPM
- Addition of "Type key code for fieldsystems"
- Adaption of "Type key code" for Display- and E-Box modul
- Addition of section "Type code"
- Moving subsections "Type key code" to section "Type code"
- WLAN and Bluetooth merged in section "Other features"
- Addition of section "Optical acceptance of surfaces"
- Moving subsection "UPDD touch driver" within section "Operating systems and drivers"
- Formal changes

Version 01.02.06

- Correction r-stahl link
- Renew DNV certification
- Addition of table "RF output power" in "Technical Data" for SERIES 400 and 500
- Removal of FSB notice
- Removal of EAC certification
- Removal of EAC summary of applied standards
- Removal of EAC Ex classification
- Removal of EAC declaration of conformity
- Addition of "Class I" in Intended use for "american requirements"
- Addition Ex marking CCC
- Renew of CCC "Declaration of conformity"
- Addition of section "Installation Instructions Requirements China"
- Addition of details for USB connection X6 in section "Ex e terminal box / terminals"
- Formal changes

Version 01.02.07

- Addition of notice according to SERIES 400 at "Teaming function"
- Addition of "Location classes" at "Technical data - Ambient conditions"
- Addition of notice for FO interfaces at "Technical data - Interfaces"
- Formal changes

R. STAHL HMI Systems GmbH
Adolf-Grimme-Allee 8
D 50829 Cologne

T:	(Sales Support)	+49 221 768 06 - 1200
	(Technical Support)	+49 221 768 06 - 5000
F:		+49 221 768 06 - 4200
E:	(Sales Support)	sales.dehm@r-stahl.com
	(Technical Support)	support.dehm@r-stahl.com

r-stahl.com



THE STRONGEST LINK.