



Position Switches

Series 8074/2

Contents

1	General Information	3
1.1	Manufacturer	3
1.2	Information about the Manual	3
1.3	Further Documents	3
1.4	Conformity with Standards and Regulations	3
2	Explanation of the Symbols	4
2.1	Symbols used in this Manual	4
2.2	Warning Notes	4
2.3	Symbols on the Device	5
3	Safety Notes	5
3.1	Storage of the Manual	5
3.2	Personnel Qualification	5
3.3	Safe Use	6
3.4	Modifications and Alterations	6
4	Function and Device Design	7
4.1	Function	7
5	Technical Data	8
6	Transport and Storage	21
7	Mounting and Installation	21
7.1	Dimensions / Fastening Dimensions	22
7.2	Mounting / Dismounting, Operating Position	23
7.3	Installation	25
8	Commissioning	29
9	Maintenance, Overhaul, Repair	29
9.1	Maintenance	29
9.2	Overhaul	30
9.3	Repair	30
9.4	Returning the Device	30
10	Cleaning	31
11	Disposal	31
12	Accessories and Spare Parts	31

1 General Information

1.1 Manufacturer

R. STAHL Schaltgeräte GmbH
Am Bahnhof 30
74638 Waldenburg
Germany

Phone: +49 7942 943-0
Fax: +49 7942 943-4333
Internet: www.r-stahl.com
E-Mail: info@stahl.de

1.2 Information about the Manual

ID-No.: 257036 / 807460300070
Publication Code: 2018-07-04·HB00·III·en·03

The original instructions are the English edition.
They are legally binding in all legal affairs.

1.3 Further Documents

- Data sheet
- Operating instructions

For documents in further languages, see www.r-stahl.com.

1.4 Conformity with Standards and Regulations

See certificates and EU Declaration of Conformity: www.r-stahl.com.

The device has IECEx approval. For certificate please refer to the IECEx homepage:
<http://iecex.iec.ch/>

Further national certificates can be downloaded via the following link:
<https://r-stahl.com/en/global/products/support/downloads/>.

EN 2 Explanation of the Symbols

2.1 Symbols used in this Manual

Symbol	Meaning
	Tips and recommendations on the use of the device
	Danger due to explosive atmosphere
	Danger due to live components





2.2 Warning Notes

Warnings must be observed under all circumstances, in order to minimize the risk due to construction and operation. The warning notes have the following structure:

- Signalling word: DANGER, WARNING, CAUTION, NOTICE
- Type and source of danger/damage
- Consequences of danger
- Taking countermeasures to avoid the danger or damage

	DANGER
	Danger to persons Non-compliance with the instruction results in severe or fatal injuries to persons.
	WARNING
	Danger to persons Non-compliance with the instruction can result in severe or fatal injuries to persons.
	CAUTION
	Danger to persons Non-compliance with the instruction can result in light injuries to persons.
NOTICE	
Avoiding material damage Non-compliance with the instruction can result in material damage to the device and / or its environment.	

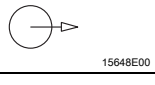
2.3 Symbols on the Device

Symbol	Significance
 0158 0594E00	CE marking according to the current applicable directive.
 02198E00	According to its marking, the device is certified for hazardous areas.
 15649E00	Input
 15648E00	Output
 11048E00	Safety instructions that must always be observed: For devices with this symbol, the corresponding data and/or the safety-relevant instructions contained in this manual must be observed!

3 Safety Notes

3.1 Storage of the Manual

- Read the manual carefully.
- Store the manual at the mounting location of the device.
- Observe applicable documents and operating instructions of the devices to be connected.

3.2 Personnel Qualification

Qualified specialist personnel are required to perform the tasks described in this manual. This primarily applies to work in the following areas:

- Project engineering
- Mounting/dismounting the device
- (Electrical) installation
- Commissioning
- Maintenance, repair, cleaning

Specialists who perform these tasks must have a level of knowledge that meets applicable national standards and regulations.

Additional knowledge is required for tasks in hazardous areas! R. STAHL recommends having a level of knowledge equal to that described in the following standards:

- IEC/EN 60079-14 (Electrical installations design, selection and construction)
- IEC/EN 60079-17 (Inspection and maintenance of electrical installations)
- IEC/EN 60079-19 (Equipment repair, overhaul and reclamation)

3.3 Safe Use

Before assembly

- Read and observe the safety notes in this manual.
- Ensure that the contents of this manual are fully understood by the personnel in charge.
- Use the device in accordance with its intended and approved purpose only.
- Always consult with R. STAHL Schaltgeräte GmbH if using the device under operating conditions not covered by the technical data.
- Make sure that the device is not damaged.
- We are not liable for damage caused by incorrect or unauthorised use of the device or by non-compliance with this manual.



For mounting and installation

- Have mounting and installation performed only by qualified and authorised persons (see "Personnel qualification" section).
- The device is only to be installed in zones for which it is suited based on its marking.
- During installation and operation, observe the information (characteristic values and rated operating conditions) on the rating, data and information plates located on the device.
- Before installation, make sure that the device is not damaged.

Commissioning, maintenance, repair

- Only have commissioning and repairs performed by qualified and authorised persons (see "Personnel qualification" section).
- Before commissioning, make sure that the device is not damaged.
- Only perform maintenance work described in this manual.
- The device must not be operated if there are dust deposits that are 50 mm thick, as stated in IEC/EN 61241-0.

3.4 Modifications and Alterations

	<p style="text-align: center;">DANGER</p> <p>Explosion hazard due to modifications and alterations to the device! Non-compliance results in severe or fatal injuries.</p> <ul style="list-style-type: none"> • Do not modify or alter the device.
	<p>No liability or warranty for damage resulting from modifications and alterations.</p>

4 Function and Device Design

	DANGER
	<p>Explosion hazard due to improper use! Non-compliance results in severe or fatal injuries.</p> <ul style="list-style-type: none"> • The device may only be used according to the operating conditions described in this manual. • Use the device only for the intended purpose specified in this manual.

4.1 Function

Application range

Position switches position, control and monitor moving parts on machines and systems. Because they meet the requirements of the EN 50 041 and IEC 60947-5-1 product standards, they can also be used as a position switch with a safety function. Series 8074/2 position switches are certified for use in hazardous areas of Zones 1, 2, 21 and 22.

Mode of operation

In conjunction with a guard door monitor and the corresponding circuitry, the PL position switches reach "e" in accordance with EN ISO 13849-1, or up to SIL 3 in accordance with EN 62061.

They are identified with the \ominus character for positive opening operation.

There are snap and slow action versions in different forms of contacts as well as in a variety of different actuating elements.

5 Technical Data

Explosion Protection

Global (IECEX)

Gas and dust	IECEX BVS 16.0085 Ex d e IIC T6 ... T5 Gb Ex tb IIIC T80°C Db
--------------	---

Europe (ATEX)

Gas and dust	BVS 05 ATEX E 007 ⊕ II 2 G Ex d e IIC T6 ... T5 Gb ⊕ II 2 D Ex tb IIIC T80°C Db
--------------	---

Certifications and certificates

Certificates	IECEX, ATEX, Russia (TR)
--------------	--------------------------

Technical Data

Version	8074/2-.-W, -R, -SR, -DL, -WH, -WPH, -D, -DS, -DD
---------	---

Electrical data

Rated operational voltage U_e		8074/2-1 8074/2-2 8074/2-5	8074/2-3
	Alternating voltage for equal potential: Alternating voltage for unequal potential: Direct voltage:	max. 500 V max. 250 V 125 V	max. 400 V max. 250 V 125 V

Rated operational current I_e	4.4 A: +70 °C (T6); 6.6 A: +70 °C (T5)
---------------------------------	---

Switching capacity	AC-12	AC-15	DC-12
	8074/2-1 8074/2-2 8074/2-5	8074/2-3	8074/2-1 8074/2-2 8074/2-5
	max. 250 V max. 500 V **) max. 4 A max. 5000 VA	max. 250 V max. 400 V **) max. 4 A max. 4000 VA	max. 250 V max. 500 V **) max. 4 A max. 1000 VA

**) only with the same potential

Rated insulation voltage	250 V
Rated impulse withstand voltage	4 kV
Short circuit protection	6 A (time lag)

Ambient conditions

Operating temperature range	-40 to +70 °C, T6 (max. 4.4 A) -40 to +70 °C, T5 (max. 6.6 A)
-----------------------------	--

Technical Data

Version	8074/2-.-AZ-20	
Electrical data		
Rated operational voltage U_e	8074/2-.-AZ-20	
	Alternating voltage:	250 V AC
	Direct voltage:	230 V DC
Rated operational current I_e	max. 6 A: $-20\text{ °C} < T_a < +60\text{ °C}$, 250 V AC; max. 0.25 A: $-20\text{ °C} < T_a < +60\text{ °C}$, 230 V DC	
Switching capacity	AC-15	DC-13
	max. 250 V max. 6 A	max. 230 V max. 0.25 A
Rated insulation voltage	250 V	
Rated impulse withstand voltage	4 kV	
Short circuit protection	6 A gN / gG	
Ambient conditions		
Operating temperature range	-20 to +40 °C (T6)	
	-20 to +60 °C (T5)	

Technical Data

Version	8074/2-.-W, -R, -SR, -DL, -WH, -WPH, -D, -DS, -DD, -AZ-20	
Mechanical data		
Maximum switching frequency	max. 1800 operating cycles/h	
Degree of protection	IP66 -40 °C (DIN EN 60529)	
Mechanical shock resistance	Snap-action contact:	2 g
	Slow-action contact:	20 g
Material		
Enclosure	Corrosion-resistant aluminium, powder-coated Similar to RAL 7016	
Cover	1.4401 stainless steel, blasted	
Mounting / Installation		
Cable entries	8161/7-M20.. on the enclosure bottom: 1 x M20 x 1.5	
Connection	with cable entry 8161: For sheathed cable 4 x 2.5 mm ² (Ø 4 to 13 mm); 4 x 1.5 mm ² recommended	
Terminals	0.75 to 2.5 mm ² , 0.75 to 1.5 mm ² (8074/2-.-AZ-20) solid, finely stranded with or without core end sleeve; additional outer protective conductor connection up to max. 4 mm ²	
Tightening torque	Screw terminals:	0.4 Nm max.
	Cover screws:	1.5 to 2 Nm
	Cable entries:	See installation note (enclosed unattached)

Technical Data

Contact

Version

Slow-action contact

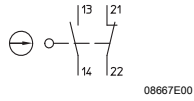

8074/2-1

08667E00

Snap-action contact

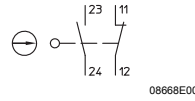

8074/2-2

08668E00

Slow-action contact, overlapping

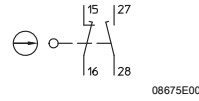

8074/2-5

08675E00

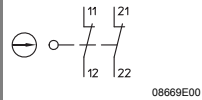

8074/2-3

08669E00

Caution:

The positive opening operation \ominus function depends on the actuator

Contact arrangement

2-pole, galvanically separated with double break

Contact opening

≥ 1.5 mm (isolating distance ≥ 3 mm)

Material

Contacts

Silver-nickel

Enclosure contact

Polyamide, glass fibre reinforced

Service life

Mechanical

max. 10^6 operating cycles

electrical

max. 10^6 operating cycles

Technical data

Operation, operating speed, switching travel or switching angle

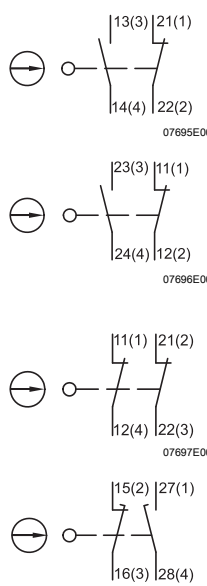
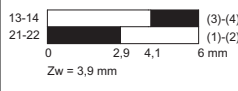
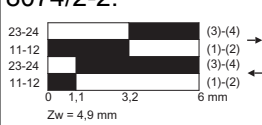
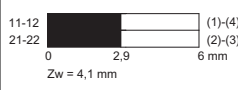
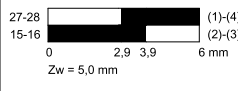
Actuator type	Actuation	Schematic	Nominal switching travel or switching angle	Minimum force/torque
Type 8074/2	V = Max. operating speed	⊕ = Positive opening operation	■ = Closed contact □ = Open contact Zw = Positive opening distance	
Plunger 8074/2.-W-40	For lateral actuation: V = 0.5 m/s Actuation in stroke direction: V = 1.0 m/s		In stroke direction 8074/2-1:  8074/2-2:  8074/2-3:  8074/2-5: 	22 N

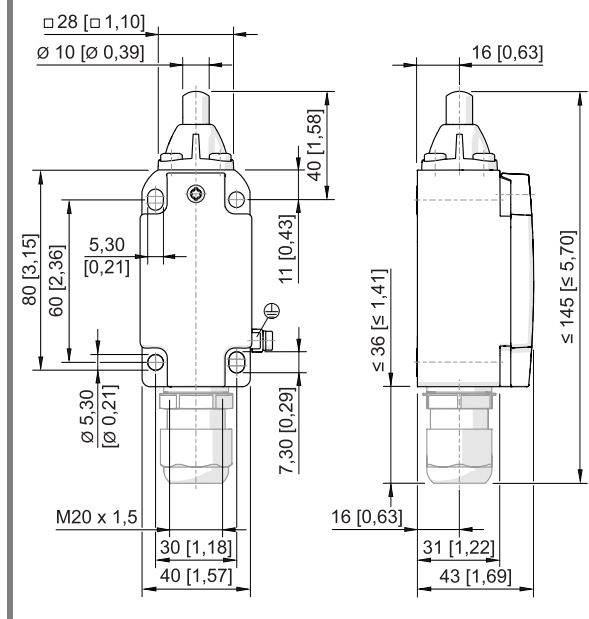

18822E00

Technical data

Operation, operating speed, switching travel or switching angle

Actuator type	Actuation	Schematic	Nominal switching travel or switching angle	Minimum force/torque
Type 8074/2	V = Max. operating speed	⊕ = Positive opening operation	■ = Closed contact □ = Open contact Zw = Positive opening distance	
Roller plunger 8074/2.-R-40	For lateral actuation: V = 1.0 m/s Actuation in stroke direction: V = 1.0 m/s		In stroke direction 8074/2-1: 13-14 (3)-(4) 21-22 (1)-(2) Zw = 3,9 mm 18999E00 8074/2-2: 23-24 (3)-(4) 11-12 (1)-(2) 23-24 (3)-(4) 11-12 (1)-(2) Zw = 4,9 mm 19051E00 8074/2-3: 11-12 (1)-(4) 21-22 (2)-(3) Zw = 4,1 mm 18999E00 8074/2-5: 27-28 (1)-(4) 15-16 (2)-(3) Zw = 5,0 mm 19000E00	22 N
			18820E00	

Technical data

Operation, operating speed, switching travel or switching angle

Actuator type	Actuation	Schematic	Nominal switching travel or switching angle	Minimum force/torque
Type 8074/2	V = Max. operating speed	⊕ = Positive opening operation	■ = Closed contact □ = Open contact Zw = Positive opening distance	
Misalignment switch 8074/2-.SR-40			Only for use with snap-action contact! 8074/2-1: 8074/2-2: 	2.5 N

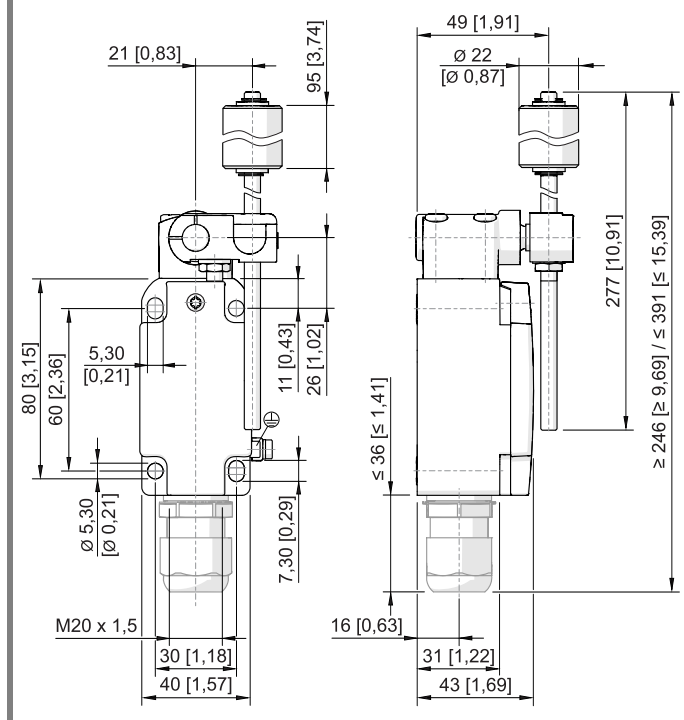

18821E00

Technical data

Operation, operating speed, switching travel or switching angle

Actuator type	Actuation	Schematic	Nominal switching travel or switching angle	Minimum force/torque
Type 8074/2	V = Max. operating speed	⊕ = Positive opening operation	■ = Closed contact □ = Open contact Zw = Positive opening distance	
Long rotary lever 8074/2-.DL-40			<p>8074/2-1:</p> <p>8074/2-2:</p> <p>8074/2-3:</p> <p>8074/2-5:</p>	3 N

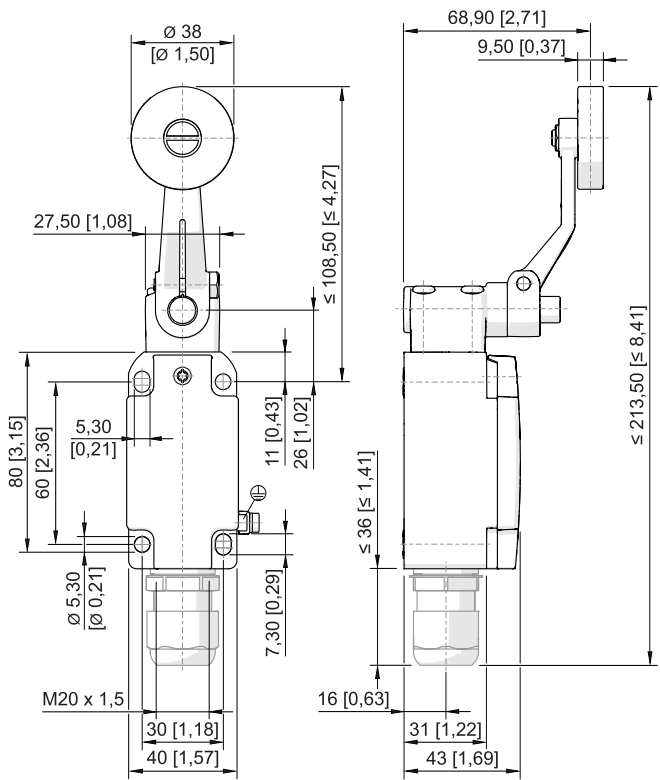

18818E00

Technical data

Operation, operating speed, switching travel or switching angle

Actuator type	Actuation	Schematic	Nominal switching travel or switching angle	Minimum force/torque
Type 8074/2	V = Max. operating speed	<p>⊕ = Positive opening operation</p>	<p>■ = Closed contact □ = Open contact Zw = Positive opening distance</p>	
Roller lever 8074/2-.-WH-40	V = 1.0 m/s		<p>Displacement of the roller in the stroke direction of the plunger at the start of the plunger movement</p> <p>8074/2-1: </p> <p>8074/2-2: </p> <p>8074/2-3: </p> <p>8074/2-5: </p>	18 N

Technical data

Operation, operating speed, switching travel or switching angle

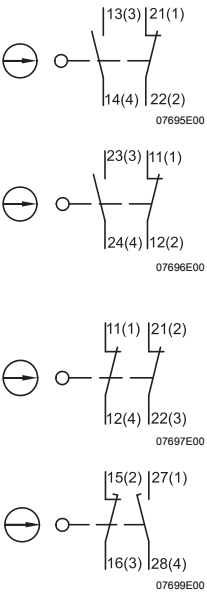
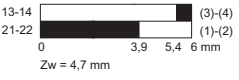
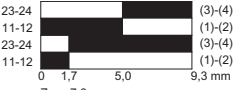
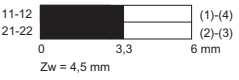
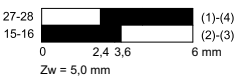
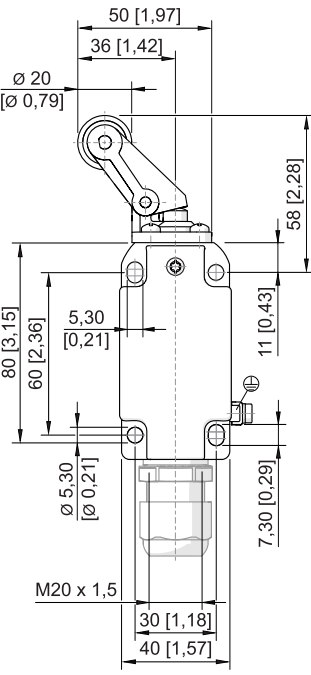
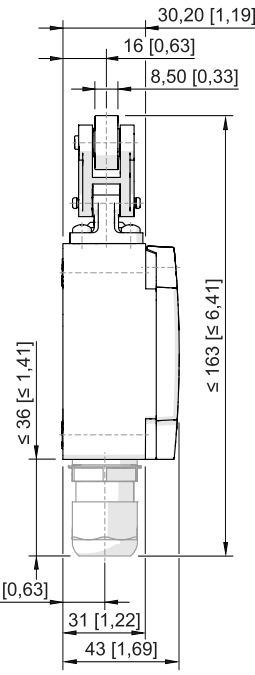
Actuator type	Actuation	Schematic	Nominal switching travel or switching angle	Minimum force/torque
Type 8074/2	V = Max. operating speed	⊕ = Positive opening operation	■ = Closed contact □ = Open contact Zw = Positive opening distance	
Parallel roller lever 8074/2-.-WPH-40	V = 1.0 m/s		Displacement of the roller vertically in the stroke direction of the plunger at the start of the plunger movement 8074/2-1:  Zw = 4,7 mm 19004E00 8074/2-2:  Zw = 7,6 mm 19059E00 8074/2-3:  Zw = 4,5 mm 19005E00 8074/2-5:  Zw = 5,0 mm 19057E00	18 N
				

18824E00



Technical data

Operation, operating speed, switching travel or switching angle

Actuator type	Actuation	Schematic	Nominal switching travel or switching angle	Minimum force/torque
Type 8074/2	V = Max. operating speed	⊕ = Positive opening operation	■ = Closed contact □ = Open contact Zw = Positive opening distance	
Rotary lever 8074/2-.D-40	V = 1.5 m/s		<p>8074/2-1:</p> <p>8074/2-2:</p> <p>8074/2-3:</p> <p>8074/2-5:</p>	7 N

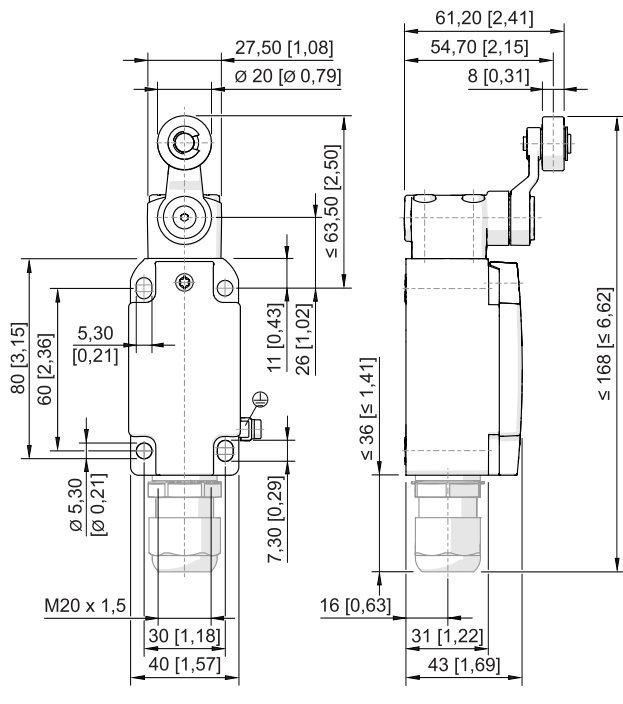

18816E00

Technical data

Operation, operating speed, switching travel or switching angle

Actuator type	Actuation	Schematic	Nominal switching travel or switching angle	Minimum force/torque
Type 8074/2	V = Max. operating speed	⊕ = Positive opening operation	■ = Closed contact □ = Open contact Zw = Positive opening distance	
Adjustable rotary lever 8074/2-.DS-40	V = 1.5 m/s Positive opening operation, not suitable for safety circuits		<p>8074/2-1:</p> <p>8074/2-2:</p> <p>8074/2-3:</p> <p>8074/2-5:</p>	4.5 N

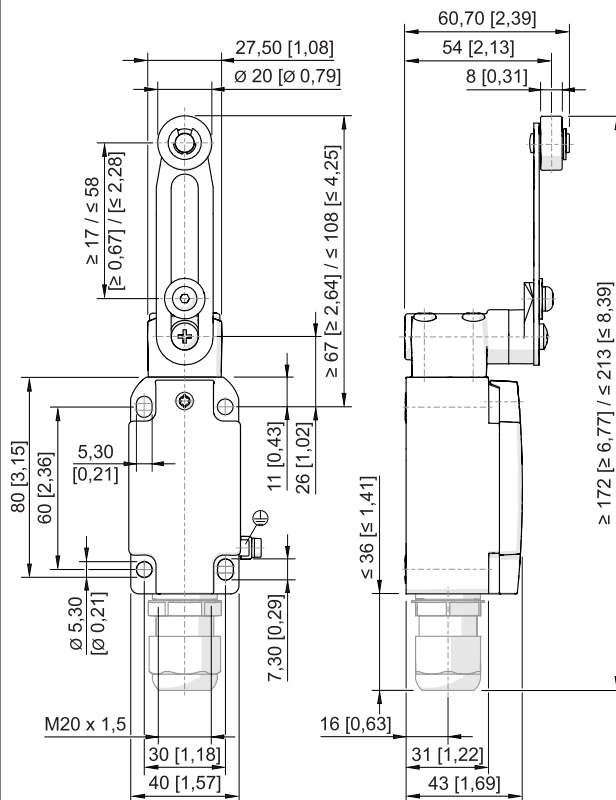

18819E00

Technical data

Operation, operating speed, switching travel or switching angle

Actuator type	Actuation	Schematic	Nominal switching travel or switching angle	Minimum force/torque
Type 8074/2	V = Max. operating speed	⊕ = Positive opening operation	■ = Closed contact □ = Open contact Zw = Positive opening distance	
Rod lever 8074/2-.DD-40	V = 1.5 m/s Positive opening operation, not suitable for safety circuits		<p>8074/2-1:</p> <p>8074/2-2:</p> <p>8074/2-3:</p> <p>8074/2-5:</p>	2.5 N

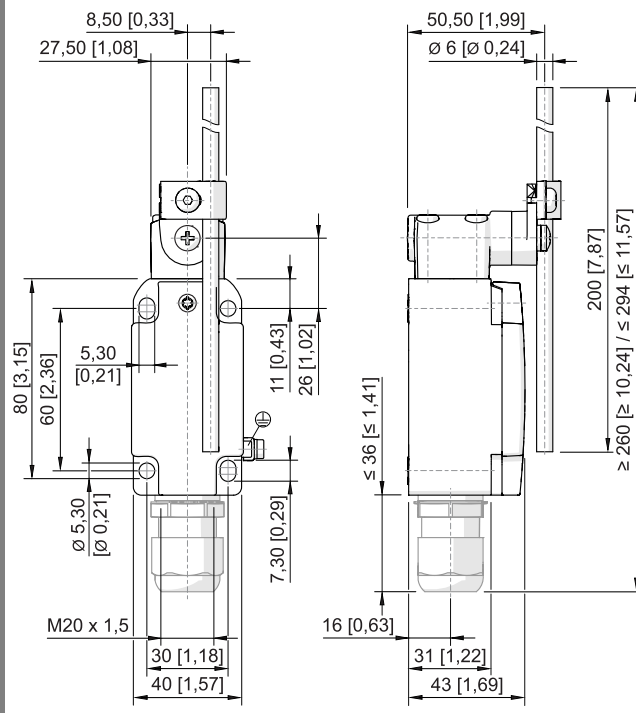

18817E00

Technical data

Operation, operating speed, switching travel or switching angle

Actuator type	Actuation	Schematic	Nominal switching travel or switching angle	Minimum force/torque
Type 8074/2	V = Max. operating speed	⊕ = Positive opening operation	■ = Closed contact □ = Open contact Zw = Positive opening distance	
Safety switch 8074/2-.-AZ-20			8074/2-1: 	17 N
			8074/2-3: 	

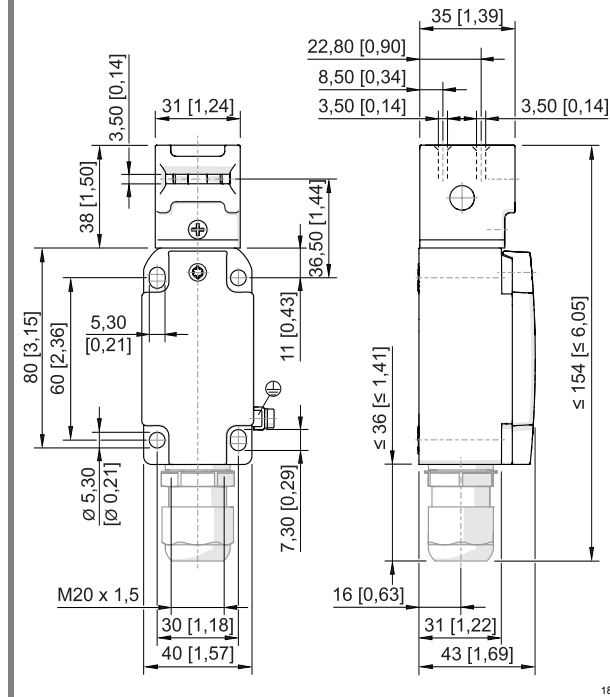

Note:
 Depiction of the switching travel when the actuator is engaged.
 The actuators must be ordered separately.

For further technical data, see www.r-stahl.com.

6 Transport and Storage

- Transport and store the device only in the original packaging.
- Store the device in a dry place (no condensation) and vibration-free.
- Do not drop the device.

7 Mounting and Installation

The device is approved for use in gas explosion hazardous areas of Zones 1 and 2 and dust explosion hazardous area of Zones 21 and 22 and in safe areas.

DANGER	
	<p>Explosion hazard due to incorrect installation of the device! Non-compliance results in severe or fatal injuries.</p> <ul style="list-style-type: none"> • Carry out installation strictly according to the instructions and national safety and accident prevention regulations to maintain the explosion protection. • Select and install the electrical device so that explosion protection is not affected due to external influences, i.e. pressure conditions, chemical, mechanical, thermal and electric impact such as vibration, humidity and corrosion (see IEC/EN 60079-14). • The device must only be installed by trained qualified personnel who is familiar with the relevant standards.

7.1 Dimensions / Fastening Dimensions

Dimensional drawings (all dimensions in mm [inches]) – Subject to modifications

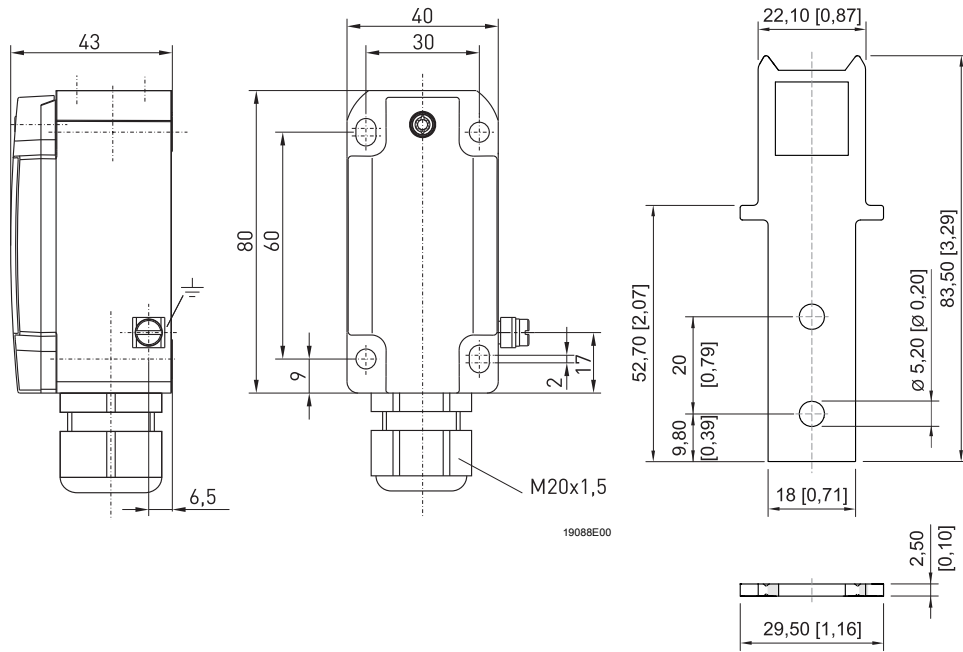

19088E00

18928E00

Position switch 8074/2

Straight actuator for safety switch

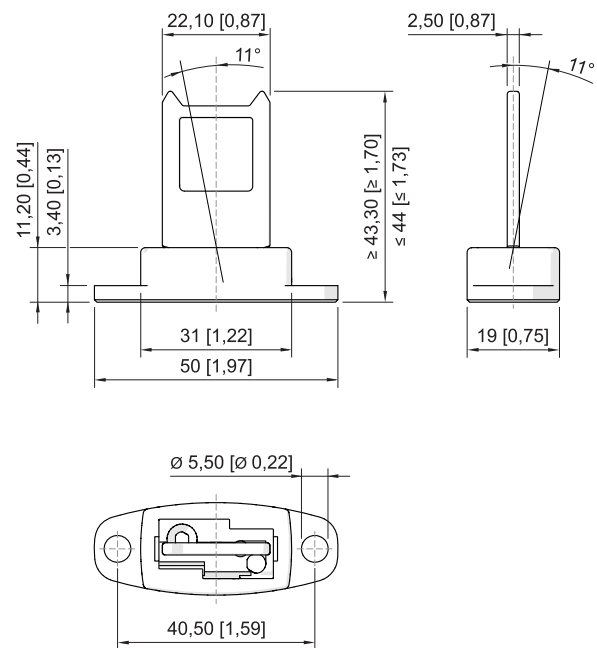
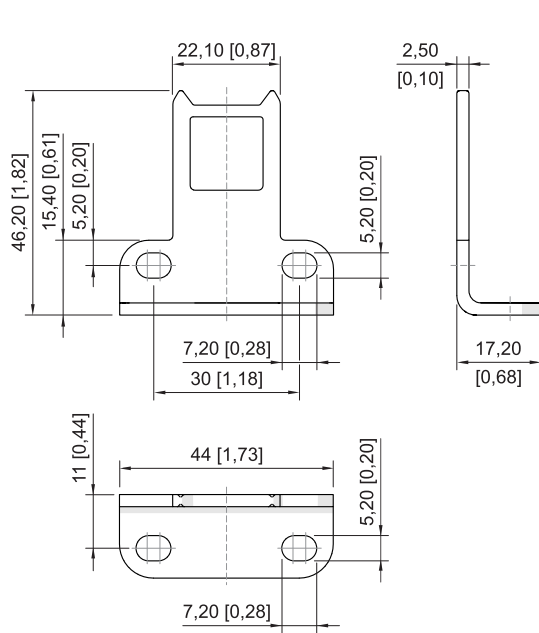

18928E00

18930E00

Bent actuator for safety switch

Movable actuator for safety switch

7.2 Mounting / Dismounting, Operating Position

7.2.1 Actuator Overview

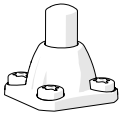
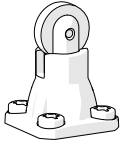
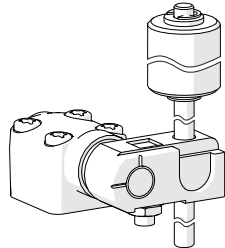
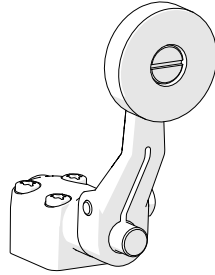
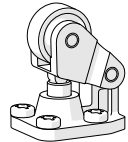
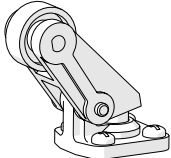
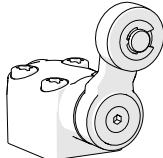
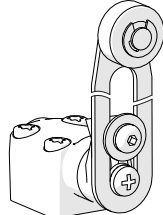
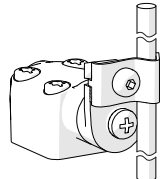
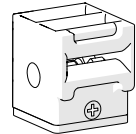
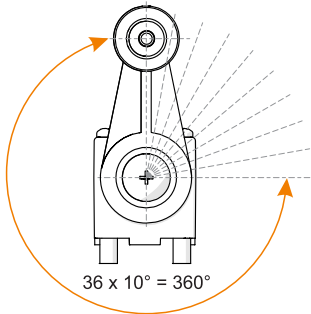
 <p>Plunger 8074/2.-W-40</p> <p>18920E00</p>	 <p>Roller plunger 8074/2.-R-40</p> <p>18917E00</p>	 <p>Misalignment switch 8074/2.-SR-40</p> <p>18918E00</p>	 <p>Long rotary lever 8074/2.-DL-40</p> <p>18915E00</p>	 <p>Roller lever 8074/2.-WH-40</p> <p>18921E00</p>
 <p>Parallel roller lever 8074/2.-WPH-40</p> <p>18922E00</p>	 <p>Rotary lever 8074/2.-D-40</p> <p>18913E00</p>	 <p>Adjustable rotary lever 8074/2.-DS-40</p> <p>18916E00</p>	 <p>Rod lever 8074/2.-DD-40</p> <p>18914E00</p>	 <p>Safety switch 8074/2.-AZ-20</p> <p>18912E00</p>
 <p>36 x 10° = 360°</p> <p>Slewing range</p> <p>18538E00</p>				

7.2.2 Actuator Assembly

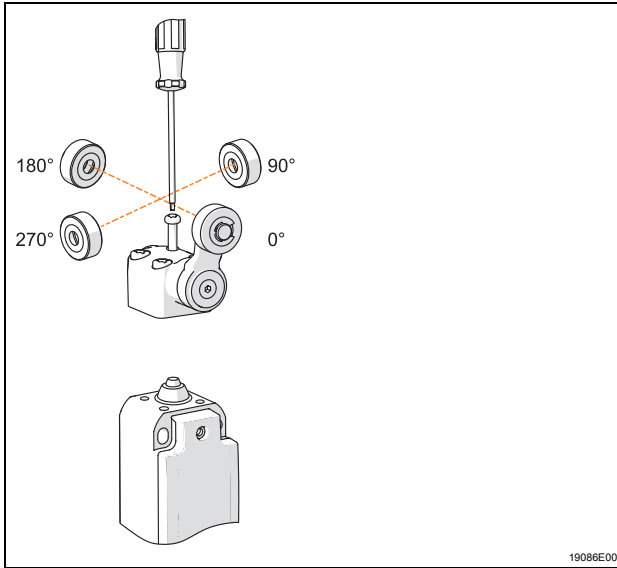

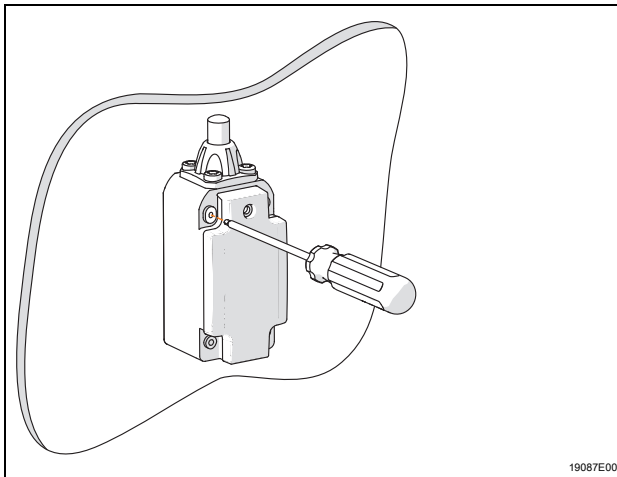

- Place the actuator in the desired position on the end switch. Can be rotated 90° in 4 different ways.
- Tighten the actuator using 4 screws and with a torque of 1 to 1.5 Nm.

7.2.3 Wall Mounting



- Mount the position switch enclosure in a suitable location with a torque of 1.3 to 1.8 Nm.
- Mount the device carefully and only in accordance with the safety notes.
- Mount the device torsion-free only on a level surface.

7.3 Installation

	<p style="text-align: center;">DANGER</p> <p>Explosion hazard due to improper installation or operation! Non-compliance results in severe or fatal injuries.</p> <ul style="list-style-type: none"> • Do not use position switch as a mechanical stop. • Protect it from changing position when used with a safety function.
	<p>Operation under difficult conditions, such as, in particular, on ships, requires additional measures to be taken for correct installation, depending on the place of use. Further information and instructions on this can be obtained from your regional sales contact on request.</p>

7.3.1 Mains Connection

	<p>If core end sleeves are used, they must be gas-tight and attached using a suitable tool.</p>
---	---

- The conductor must be connected carefully.
- The conductor insulation must reach to the terminal. Do not damage (nick) the conductor when stripping it.
- Ensure that the maximum permissible conductor temperatures are not exceeded by performing a suitable selection of electric lines used and means of running them.
- The specifications for the terminals are to be observed (see "Technical Data").

7.3.2 Back-Up Fuse

A back-up fuse with max. 6 A tripping characteristic gN/gG according to IEC 60269-1 can be used for short-circuit protection.

7.3.3 Snap Switch Connection (for 8074/2-2-...)

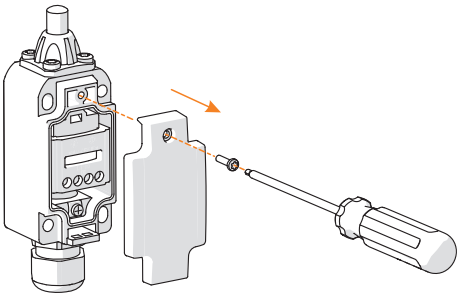
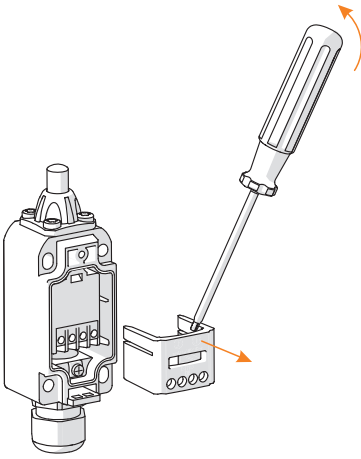
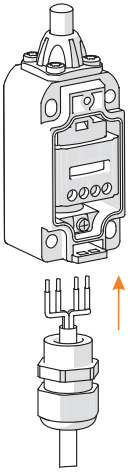
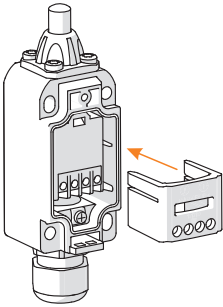
 <p>19021E00</p>	<ul style="list-style-type: none"> • Loosen the enclosure cover screw. • Remove the enclosure cover.
 <p>19022E00</p>	<ul style="list-style-type: none"> • Remove insert (e.g. using a screwdriver).
<p>18599E00</p>	<ul style="list-style-type: none"> • Strip the 6 mm connection line. • Do not damage the conductor when removing the insulation.
 <p>19023E00</p>	<ul style="list-style-type: none"> • Connect the connection line to the terminal on the contact block using a torque of 0.4 Nm. • Guide the connection line insulation to the clamping unit.
 <p>19024E00</p>	<ul style="list-style-type: none"> • Insert the insert into the enclosure.

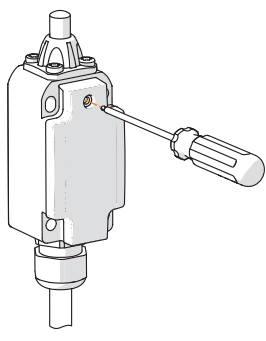
 <p style="text-align: right; font-size: small;">19016E00</p>	<ul style="list-style-type: none"> • Close the enclosure using the enclosure cover. • Fasten the enclosure cover with a torque of 1.5 to 2 Nm.
--	--

7.3.4 Slow-Action Circuit Connection

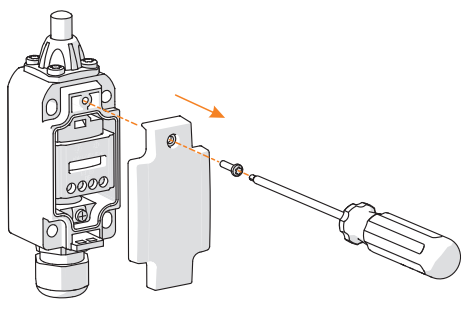
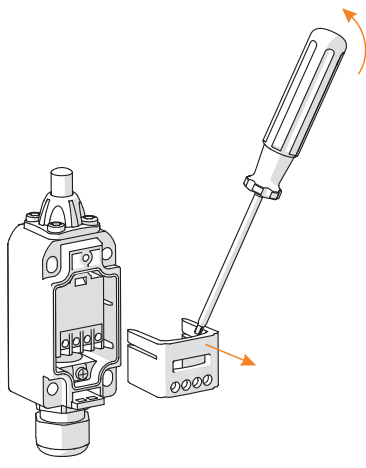
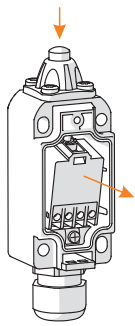
 <p style="text-align: right; font-size: small;">19021E00</p>	<ul style="list-style-type: none"> • Loosen the enclosure cover screw. • Remove the enclosure cover.
 <p style="text-align: right; font-size: small;">19022E00</p>	<ul style="list-style-type: none"> • Remove insert (e.g. using a screwdriver).
 <p style="text-align: right; font-size: small;">19017E00</p>	<ul style="list-style-type: none"> • Press the actuator and simultaneously tilt the contact block to the outside.

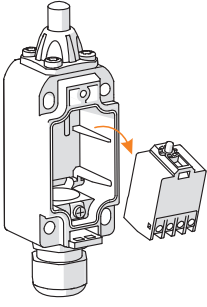
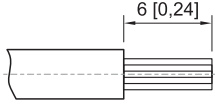
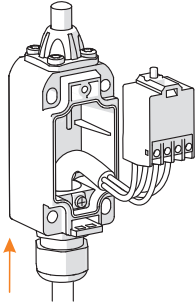
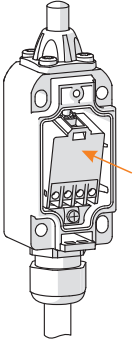
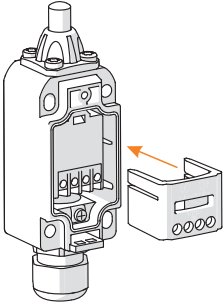
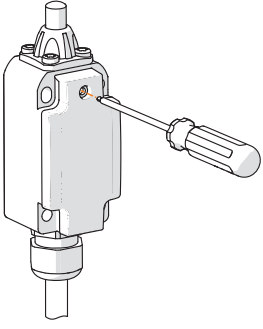
 <p style="text-align: right;">19018E00</p>	<ul style="list-style-type: none"> Remove the contact block.
 <p style="text-align: right;">18599E00</p>	<ul style="list-style-type: none"> Strip the 6 mm connection line. Do not damage the conductor when removing the insulation.
 <p style="text-align: right;">19019E00</p>	<ul style="list-style-type: none"> Connect the connection line to the terminal on the contact block using a torque of 0.4 Nm. Guide the connection line insulation to the clamping unit.
 <p style="text-align: right;">19020E00</p>	<ul style="list-style-type: none"> Insert the contact block into the enclosure.
 <p style="text-align: right;">19024E00</p>	<ul style="list-style-type: none"> Insert the insert into the enclosure.
 <p style="text-align: right;">19016E00</p>	<ul style="list-style-type: none"> Close the enclosure using the enclosure cover. Fasten the enclosure cover with a torque of 1.5 to 2 Nm.

7.3.5 Cable Entry Assembly

	Cable entry assembly, see Brief Instructions attached.
---	--

8 Commissioning

	DANGER
	<p>Explosion hazard due to incorrect installation! Non-compliance results in severe or fatal injuries.</p> <ul style="list-style-type: none"> • Check the device for proper installation before commissioning. • Comply with national regulations.

Before commissioning, ensure the following:

- Check to see if the enclosure is damaged.
- Check to see if parts of the flameproof enclosure are damaged.
- If necessary, remove foreign bodies.
- If necessary, clean the connection chamber.
- Check if the conductors have been inserted correctly.
- Check to see if the conductors / wires have been installed properly.
- Check if all screws and nuts have been tightened firmly.
- Check whether all the cable entries and stopping plugs have been tightened firmly.

9 Maintenance, Overhaul, Repair



9.1 Maintenance

- Consult the relevant national regulations to determine the type and extent of inspections.
- Adapt inspection intervals according to the operating conditions.

At a minimum, check the following points during maintenance work on the device:

- Firm fit of the conductors,
- Compliance with the permissible temperatures (according to IEC/EN 60079),
- Damage to the enclosure and seals.

9.2 Overhaul

	DANGER
	<p>Overheating and explosion hazard due to defective switching contacts! Non-compliance results in severe or fatal injuries.</p> <ul style="list-style-type: none"> • Replace the switch after each short circuit in the main circuit (the element is hermetically sealed and the state of the switching contacts cannot be checked).
	<p>Observe the relevant national regulations in the country of use.</p>

9.3 Repair

	DANGER
	<p>Explosion hazard due to improper repair! Non-compliance results in severe or fatal injuries.</p> <ul style="list-style-type: none"> • Repair work on the devices must be performed only by R. STAHL Schaltgeräte GmbH.

9.4 Returning the Device

- Only return or package the devices after consulting R. STAHL!
Contact the responsible representative from R. STAHL.

R. STAHL's customer service is available to handle returns if repair or service is required.

- Contact customer service personally.

or

- Go to the www.r-stahl.com website.
- Under "Support" > "RMA form", select "Request RMA slip".
- Fill out the form and send it.
Confirmation will be sent. R. STAHL's customer service will contact you.
You will receive an RMA slip after speaking with customer service.
- Send the device along with the RMA slip in the packaging to R. STAHL Schaltgeräte GmbH (refer to Section 1.1 for the address).

10 Cleaning

- To avoid electrostatic charging, the devices located in potentially explosive areas may only be cleaned using a damp cloth.
- When cleaning with a damp cloth, use water or mild, non-abrasive, non-scratching cleaning agents.
- Do not use aggressive detergents or solvents.

11 Disposal

- Observe national and local regulations and statutory regulation regarding disposal.
- Separate materials when sending it for recycling.
- Ensure environmentally friendly disposal of all components according to the statutory regulations.

12 Accessories and Spare Parts

NOTICE

Malfunction or damage to the device due to the use of non-original components.

Non-compliance can result in material damage.

- Use only original accessories and spare parts from R. STAHL Schaltgeräte GmbH.



For accessories and spare parts, see data sheet on our homepage www.r-stahl.com.