

Mounting plates Series 8298

STAHL



- > For quick and easy mounting of explosion-protected operating and monitoring devices on pipes and mesh cable trays
- > Material: Stainless steel 1.4301
- > Suitable for vertical and horizontal mounting of the devices
- > Easy installation of protective roofs
- > Insertable designation labels
- > Mounting options:
 - on mesh cable trays with grid dimension of 30 mm using clamps
 - on pipes 1 1/4", 1 1/2" or 2" using pipe clamps
 - directly to walls
- > Quick installation system for a time-saving plug-in/screw mounting of built-on devices on the mounting plate

www.stahl.de



02850E00

The quick installation system of the mounting plate allows operating and monitoring devices to be installed on the mounting plate in a time-saving and easy way, as is the case with junction boxes and small terminal boxes.

The mounting plates have to be fixed on pipes or mesh cable trays using pipe clamps or mounting brackets in a simple and cost-saving way.

E9

WebCode 8298C

Mounting plates

Series 8298

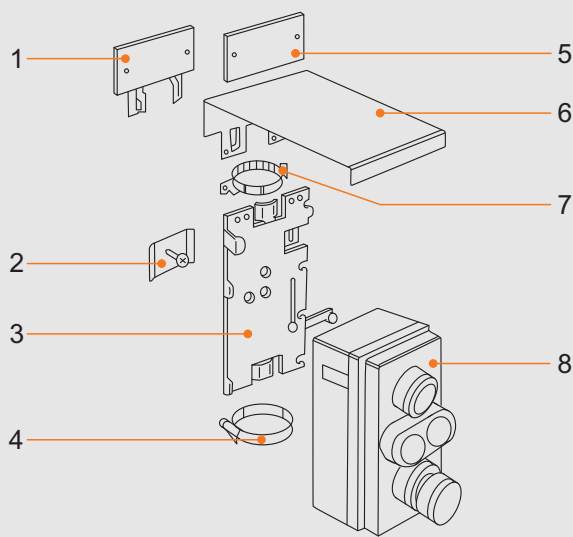



- 1 Label holder
- 2 Clamp
- 3 Mounting plate
- 4 Pipe clamp 1 1/4" or 1 1/2"
- 5 Label
- 6 Roof
- 7 Pipe clamp 2"
- 8 Control device

18306E00

Mounting plates

Series 8298

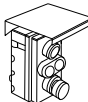
Selection Table

Version	Description	Art. no.	Weight kg
Roof 	for attaching to the mounting plate Material: Stainless steel 1.4301; suitable for enclosures		
for vertically installed mounting plates 	The roof is suitable for the following enclosures: 8040/1 8118/.1	143894	0.148
	The roof is suitable for the following enclosures: 8040/2	143896	0.195
	The roof is suitable for the following enclosures: 8146/.031 8146/5-V11-300 8146/5-V37-300 8146/.041 8146/5-V11-301 8146/5-V37-301 8146/.241 8146/5-V11-302	143898	0.256
	The roof is suitable for the following enclosures: 8146/.242 8146/5-V27-1	143900	0.305
	The roof is suitable for the following enclosures: 8146/.051 8146/5-V11-303 8146/5-V37-303 8146/.061 8146/5-V11-604 8146/5-V37-604	143906	0.370
	The roof is suitable for the following enclosures: 8146/.052 8146/5-V27-2 8146/5-V37-302 8146/.062 8146/5-V37-305	143908	0.100
	The roof is suitable for the following enclosures: 8146/5-V37-302 8146/5-V37-305	143910	0.365
	The roof is suitable for the following enclosures: 8146/.072 8146/5-V11-305 8146/5-V27-3 8146/.S72 8146/5-V27-4 8146/5-V27-5 8146/5-V27-6	143912	0.404
	The roof is suitable for the following enclosures: 8118/.2 8118/.3	143918	0.193
	for horizontally installed mounting plates 	The roof is suitable for the following enclosures: 8146/.031 8146/.041 8146/.051 8146/.061 8146/.241	143902
The roof is suitable for the following enclosures: 8146/.052 8146/.062 8146/.242		143904	0.521
The roof is suitable for the following enclosures: 8146/.071 8146/.S71		143914	0.100
The roof is suitable for the following enclosures: 8146/.072 8146/.S72		143916	0.100

Mounting plates

Series 8298

Dimensional drawings (all dimensions in mm [inches]) – Subject to modifications

Mounting plates 8298 incl. accessories

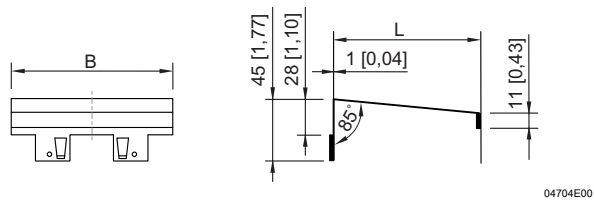

Roof

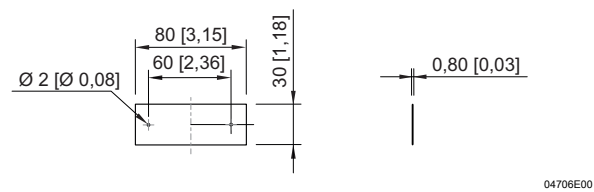

Label

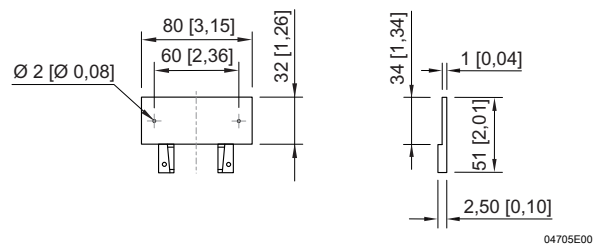

Label holder

Art. no.	Dimensions	
	L	B
143918	90	185
143916	200	400
134914	160	400
143912	200	220
143910	160	220
143908	200	220
143906	160	220
143904	200	270
143902	160	270
143900	200	160
143898	160	160
143896	160	120
143894	110	120

We reserve the right to make alterations to the technical data, dimensions, weights, designs and products available without notice. The illustrations cannot be considered binding.