

Plug and Socket Devices SolConeX 32 A Series 8571



www.stahl.de



12128E00

- > Switch socket / plug 32 A
- > Minimal force required to insert and remove
- > With motor switching capacity AC-3 acc. to IEC 60947-3
- > Large switching handle
 - with clear position indication
 - able to be padlocked in 0- and I-position
- > Self-cleaning contacts for superior reliability
- > Can be optionally equipped with an auxiliary contact for control and signalling purposes
- > IP66 in any application position



E3

The SolConeX plug and socket devices Series 8571 are 32 A versions. An important safety criterion is the reliable load disconnect switch with the large, highly visible handle. Plugging in and unplugging is done easily and safely in 0 position. The plugs and sockets comply with IEC/EN 60309-1/-2/-4 (CEE), IEC/EN 60079-0, IEC/EN 60079-1 and IEC/EN 60079-7. The ability to plug the Ex-plug in non-Ex-sockets is guaranteed, while operation of the Ex-socket using a non-Ex-plug is reliably prevented.







	ATEX / IECEx						Zone	NEC 505 Class I						Division	NEC 506 Class II						NEC 500 Class III					
	0	1	2	20	21	22		0	1	2	20	21	22		1	2	1	2	1	2	1	2	1	2	1	2
For use in		x	x		x	x	For use in		x	x					For use in		x	x	x	x	x	x	x	x	x	

WebCode 8571A

Plug and Socket Devices SolConeX 32 A Series 8571



Selection Table

Version	No. of poles	Voltage [V]	Colour code	Frequency Hz	h	Metal adaptor	Order number	Weight kg	
SolConeX 32 A switch socket  10324E00	 06556E00 4 P (3 P + PE)	>50	green	100-300 ^{*)}	10	--	8571/11-410	2.200	
		200 ... 250	blue	50 and 60	9	--	8571/11-409	2.200	
		380 ... 415	red	50 and 60	6	--	8571/11-406	2.200	
		440 ... 460	red	60	11	--	8571/11-411	2.200	
		480 ... 500	black	50 and 60	7	--	8571/11-407	2.200	
		600 ... 690	black	50 and 60	5	--	8571/11-405	2.200	
		220 / 240 ... 380 / 415	red	50	3	--	8571/11-503	2.200	
		57 / 100 ... 75 / 130	yellow	50 and 60	4	--	8571/11-504	2.200	
		120 / 208 ... 144 / 250	blue	50 and 60	9	--	8571/11-509	2.200	
		200 / 346 ... 240 / 415	red	50 and 60	6	--	8571/11-506	2.200	
	 06555E00 5 P (3 P + N + PE)	250 / 440 ... 265 / 460	red	60	11	--	8571/11-511	2.200	
		277 / 480 ... 288 / 500	black	50 and 60	7	--	8571/11-507	2.200	
		347 / 600 ... 400 / 690	black	50 and 60	5	--	8571/11-505	2.200	
		Variants with metal earth plate for two metal cable entries and stopping plugs							
		 06556E00 4 P (3 P + PE)	200 ... 250	blue	50 and 60	9	M32 x 1.5	8571/11-409-S012	2.200
			380 ... 415	red	50 and 60	6	M32 x 1.5	8571/11-406-S012	2.200
			480 ... 500	black	50 and 60	7	M32 x 1.5	8571/11-407-S012	2.200
			600 ... 690	black	50 and 60	5	M32 x 1.5	8571/11-405-S012	2.200
		 06555E00 5 P (3 P + N + PE)	200 / 346 ... 240 / 415	red	50 and 60	6	M32 x 1.5	8571/11-506-S012	2.200
			Variants with auxiliary contact (NO) and cable entry with stopping plug						
 06556E00 4 P (3 P + PE)	380 ... 415	red	50 and 60	6	--	8571/11-406-S001	2.200		
	480 ... 500	black	50 and 60	7	--	8571/11-407-S001	2.200		
	600 ... 690	black	50 and 60	5	--	8571/11-405-S001	2.200		
SolConeX 32 A plug  10324E00	 09191E00 4 P (3 P + PE)	>50	green	100-300 ^{*)}	10	--	8571/12-410	0.500	
		200 ... 250	blue	50 and 60	9	--	8571/12-409	0.500	
		380 ... 415	red	50 and 60	6	--	8571/12-406	0.500	
		440 ... 460	red	60	11	--	8571/12-411	0.500	
		480 ... 500	black	50 and 60	7	--	8571/12-407	0.500	
		600 ... 690	black	50 and 60	5	--	8571/12-405	0.500	
	 09196E00 5 P (3 P + N + PE)	120 / 208 ... 144 / 250	blue	50 and 60	9	--	8571/12-509	0.600	
		200 / 346 ... 240 / 415	red	50 and 60	6	--	8571/12-506	0.600	
		250 / 440 ... 265 / 460	red	60	11	--	8571/12-511	0.600	
		277 / 480 ... 288 / 500	black	50 and 60	7	--	8571/12-507	0.600	
		347 / 600 ... 400 / 690	black	50 and 60	5	--	8571/12-505	0.600	
		220 / 240 ... 380 / 415	red	50	3	--	8571/12-503	0.600	
		57 / 100 ... 75 / 130	yellow	50 and 60	4	--	8571/12-504	0.600	

Plug and Socket Devices SolConeX 32 A Series 8571



Explosion Protection

Global (IECEx)

Gas and dust	IECEx PTB 05.0024 Ex d e IIC T6 Gb (Ta = -30 ... +40 °C) Ex d e IIC T5 Gb (Ta = -30 ... +55 °C) with intrinsically safe auxiliary contacts: Ex d e [ia Ga] IIC T6 Gb (Ta = -30 ... +40 °C) Ex d e [ia Ga] IIC T5 Gb (Ta = -30 ... +55 °C) Ex tD A21 IP66 T75°C Db (Ta = -30 ... +55 °C) Ex tD A21 IP66 T60°C Db (Ta = -30 ... +40 °C)
--------------	--

Europe (ATEX)

Gas and dust	PTB 04 ATEX 1060 Ⓜ II 2 G Ex d e IIC T6 Gb (Ta = -30 ... +40 °C) Ⓜ II 2 G Ex d e IIC T5 Gb (Ta = -30 ... +55 °C) with intrinsically safe auxiliary contacts: Ⓜ II 2 G Ex d e [ia Ga] IIC T6 Gb (Ta = -30 ... +40 °C) Ⓜ II 2 G Ex d e [ia Ga] IIC T5 Gb (Ta = -30 ... +55 °C) Ⓜ II 2 D Ex tD A21 IP66 T75°C Db (Ta = -30 ... +55 °C) Ⓜ II 2 D Ex tD A21 IP66 T60°C Db (Ta = -30 ... +40 °C)
--------------	---

Certifications and certificates

Certificates	IECEx, ATEX, Brazil (INMETRO), China (China-Ex), India (PESO), Canada (CSA), Kazakhstan (TR), Korea (KCs), Russia (TR), Serbia (SRPS), Taiwan (ITRI), Ukraine (TR), USA (FM), Belarus (TR)
Ship approval	GL, RS

Technical Data

Electrical data

Version	Socket 8571/11, Plug 8571/12
Rated operational voltage	
Main contacts	max. 690 V AC / max. 110 V DC
Auxiliary contacts	max. 500 V AC / max. 110 V DC
Rated operational current	
Main contacts	32 A
Auxiliary contacts	max. 6 A
Switching capacity	Main contacts: AC-3: 690 V, 32 A 7.5 kW: 220 V / 230 V / 240 V 15 kW: 380 V / 400 V / 415 V 30 kW: 600 V / 690 V Auxiliary contacts: AC-15: 500 V, max. 1250 VA AC-15: 230 V, max. 1380 VA AC-12: 500 V, max. 3000 VA DC-13: 110 V, 110 W
Short-circuit protection	32 A gG
Interlocked switch	max. 4 pole switch 2 optional auxiliary contacts (ON - delayed, OFF - advanced)

Ambient conditions

Version	Socket 8571/11, Plug 8571/12
Ambient temperature	see Explosion protection -50 °C on request (internal lubrication using silicone grease)

Mechanical data

Version	Socket 8571/11
Degree of protection	IP66 acc. to IEC/EN 60529
Enclosure material	Polyamide, glass fibre reinforced, fire and saltwater resistant
Switching handle	lockable in 0 and I position
Version	Plug 8571/12
Degree of protection	IP66 acc. to IEC/EN 60529

Mounting / Installation

Version	Socket 8571/11
Connection Terminals	
Main contacts	2 x 2.5 ... 10 mm ² single-wire 2 x 2.5 ... 6 mm ² finely stranded
Cable entries	
Cable gland	1 x M32 x 1.5 (positioning on the top or at the side, according to the order)
Stopping plug	1 x M32 x 1.5
Version	Plug 8571/12
Terminals	1 x 2.5 ... 10 mm ² finely stranded
Cable entries	12 ... 28 mm cable diameter

E3

Plug and Socket Devices SolConeX 32 A Series 8571



Arrangement of Earth Contact Sockets

Example:
Clock hour position,
Front view of socket

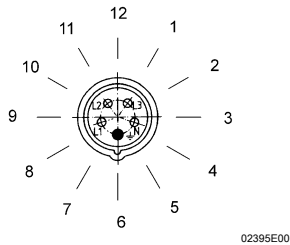

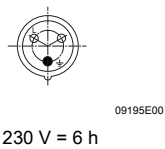

Example:
Clock hour position

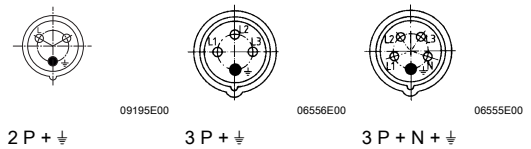

Marking of connections
Front view of socket

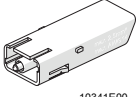

Accessories and Spare Parts

Designation	Figure	Description	Art. no.	Weight kg
Auxiliary contact (retrofitable)		1 NO	150682	0.125
		1 NC	150680	0.125
		1 NO, gold contact	150686	0.125
		1 NC, gold contact	150684	0.125
Protective cap		for plug 32 A 4 pole	150856	0.070
		for plug 32 A 5 pole	150865	0.077

Dimensional Drawings (All Dimensions in mm) - Subject to Alterations

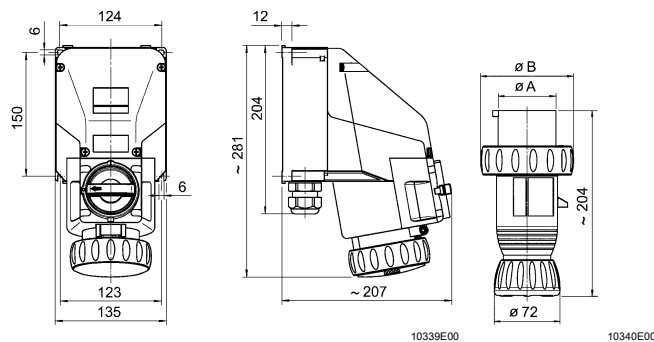

Type	A	B
8571/12-4.. (32 A, 3 P + ⚡)	57	99
8571/12-5.. (32 A, 3 P + N + ⚡)	63.4	104

8571/11-...
SolConeX 32 A switch socket

8571/12-...
SolConeX 32 A plug

We reserve the right to make alterations to the technical data, dimensions, weights, designs and products available without notice.
The illustrations cannot be considered binding.