



- Reliable load disconnect switch with easily visible, lockable handle and switching position display
- An integrated auxiliary contact for control and signalling purposes, can optionally be enhanced with pluggable, easily retrofittable Ex e or Ex i auxiliary contacts
- Wide temperature range for use
- High mechanical impact and shock resistance
- Perfect protection against the ingress of liquids and dust
- 3D data available to download from the website

E3

WebCode **8579A**



R. STAHL Series 8579/31 sockets for Zone 1/21 in a 4- and 5-pole version have full AC-3 switching capacity up to 63 A. The high degree of protection IP66 guarantees the highest level of protection against the penetration of dust and water in any application position. Self-cleaning lamellar contacts provide optimum contact and the plugs can be inserted and removed in the zero position quickly and easily. The load disconnect switch, with mechanical locking device and a handle that can be locked in the 0 or I position, is an additional safety feature.

	IECEX / ATEX					
Zone	0	1	2	20	21	22
Installation in		•	•		•	•

Selection Table								
Product Description Auxiliary contacts	Wall-mounting socket 63 A 2 (1 NO + 1 NC)							
Figure	Detailed number of poles	Coding (clock hour position)	Rated operational voltage AC	Colour code	Frequency range	Product Type	Art. No.	Weight
	3 P + N + PE	5	347/600 to 400/690 V AC	Black	50 / 60 Hz	8579/31-505	270899	8.2 kg
		6	200/346 to 240/415 V AC	Red	50 / 60 Hz	8579/31-506	270900	8.2 kg
		7	277/480 to 288/500 V AC	Black	50 / 60 Hz	8579/31-507	270901	8.2 kg
		9	120/208 to 144/250 V AC	Blue	50 / 60 Hz	8579/31-509	270902	8.2 kg
		11	250/440 to 265/460 V AC	Red	60 Hz	8579/31-511	270903	8.2 kg
	3 P + PE	5	600 to 690 V AC	Black	50 / 60 Hz	8579/31-405	270904	7.8 kg
		6	380 to 415 V AC	Red	50 / 60 Hz	8579/31-406	270905	7.8 kg
		7	480 to 500 V AC	Black	50 / 60 Hz	8579/31-407	270906	7.8 kg
		9	200 to 250 V AC	Blue	50 / 60 Hz	8579/31-409	270907	7.8 kg
		11	440 to 460 V AC	Red	60 Hz	8579/31-411	270908	7.8 kg

Technical Data	
Explosion Protection	
Scope of validity	European Union (ATEX) IECEX China (CQST)

Technical Data	
Explosion Protection	
Scope of validity Note	Other country markings available on request
IECEX gas explosion protection	Ex db eb IIC T6 ... T5 Gb
IECEX dust explosion protection	Ex tb IIIC T60 °C / T75 °C Db
ATEX gas explosion protection	Ⓜ II 2 G Ex tb eb IIC T6 ... T5 Gb
ATEX dust explosion protection	Ⓜ II 2 D Ex tb IIIC T60 °C / T75 °C Db
Certificates	ATEX (PTB), Brazil (ULB), China (CQST), IECEX (PTB), Korea (KGS), Taiwan (ITRI)
Declaration of Conformity	ATEX (EGK), China (CCC)
Electrical Data	
Rated operational current	max. 63 A
Switching capacity main contacts	AC-3 690 V, 63 A 18.5 kW: 220 / 230 / 240 V 30 kW: 380 / 400 / 415 V 37 kW: 500 V 55 kW: 690 V
Device Specific Data	
Back-up fuse with thermal protection	80 A gG
Back-up fuse without thermal protection	63 A gG
Ambient Conditions	
Ambient temperature	-45 °C to +55 °C
Ambient temperature	-49 °F to +131 °F
Notes	For further information, see the operating instructions.
Mechanical Data	
IP degree of protection (IEC 60529)	IP66
IP degree of protection (IEC 60079)	IP66
Enclosure material	Polyester, Glass fibre reinforced
Silicone-free	No
Stranded connection cross-section	1 x 16 mm ² ... 1 x 50 mm ²
Impact strength (IEC 60079)	7 J
Impact strength (IEC 62262)	IK10
Lockable in	in 0- and I-position
Components	
Cable entry note	Entry 1: Lower left Entry 2: Lower right
Entry 1 model	8161/7-M50-3516-LT
Entry 1 type	Polyamide cable gland
Entry 1	M50 x 1.5
Entry 1 terminal area	16 – 35 mm
Metal entry possible 1	No
Entry 2 model	8290/3-M25
Entry 2 type	Polyamide stopping plug
Entry 2	M25 x 1.5
Metal entry possible 2	No
Notes	Cable gland position: Bottom (standard); optionally also possible on the top or lateral

Arrangement of the Earth Contact Sleeves

Time position
Example: 6h position

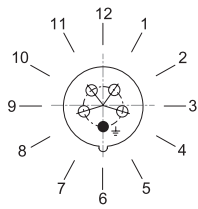

Arrangement of socket contacts and terminal markings

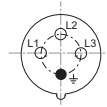

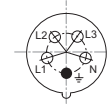

3 P + PE



3 P + N + PE

Arrangement of the socket contacts and terminal markings in the 6h position
(view from the front side of the socket to the socket contacts)

Accessories

Figure	Description	Art. No.	Weight
Auxiliary contact			
	2 NC contacts (8080/1-3) 250 V AC/DC max. 6 A 1.5 ... 2.5 mm ² solid / finely stranded The switching function of the auxiliary contact depends on the installation slot used. Left and right: synchronising	168356	26 g
	1 NC contact + 1 NO contact (8080/1-1) 250 V AC/DC max. 6 A 1.5 ... 2.5 mm ² solid / finely stranded The switching function of the auxiliary contact depends on the installation slot used. Left: delayed (ON), leading (OFF) Right: synchronising	168351	26 g
	2 NO contacts (8080/1-4) 250 V AC/DC max. 6 A 1.5 ... 2.5 mm ² solid / finely stranded The switching function of the auxiliary contact depends on the installation slot used. Left and right: synchronising	168353	26 g
Cable gland made of plastic			
	8161/7-M25-1707, Ex e Plastic, M25 x 1.5, cable outer diameter 7 to 17 mm Lot size 50 pieces	239157	19 g
Stopping plug			
	8290/3-M25 Plastic, M25 x 1.5 Lot size 1 piece	143524	10 g

Spare Parts

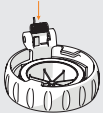
Figure	Description	Art. No.	Weight
Auxiliary contact key			
	for removing the mounted auxiliary contact	201909	35 g
Repair set for sockets series 8579			
	Repair kit 8579 hinged cover, black	275509	185 g
	Repair kit 8579 hinged cover, blue	275507	185 g
	Repair kit 8579 hinged cover, red	275508	185 g

Lot size: Purchase order quantity in [pieces], the delivery quantity is automatically rounded to the lot size.

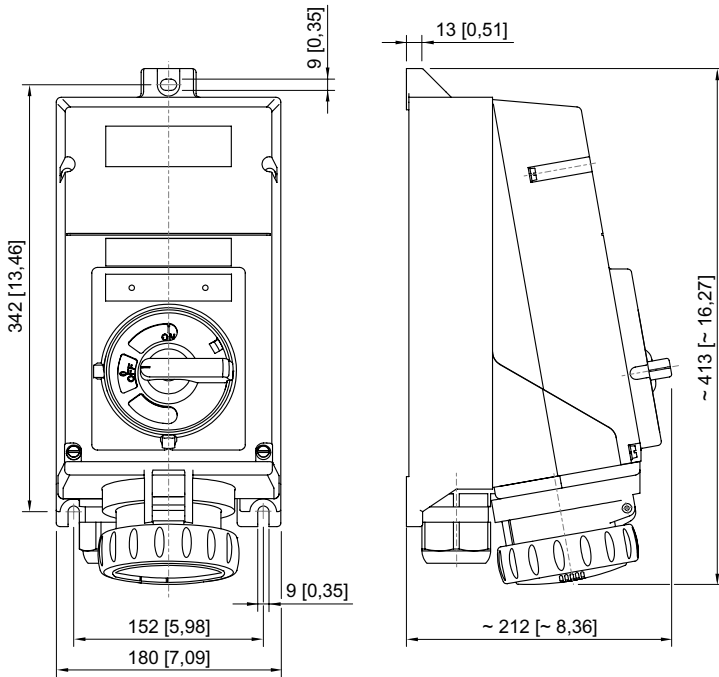

Wall-mounting socket