



- Energy-saving, bright LED technology
- Approved in accordance with the relevant firefighting standard
- Lamp head pivots 190°
- Incredibly lightweight
- Main light continuously dimmable
- Long battery life
- Ergonomic one-hand operation

E2

WebCode 6148A



The ergonomic design of the 6148 series portable LED lamp allows you to operate this lamp with just one hand. Its brightness can be freely adjusted; alternatively, it can be set to flashing mode. The pivoting lamp head allows you to direct the light cone virtually anywhere. Coloured diffusing lenses are available as accessories, and transform your lamp into a portable Ex beacon. It approved for use in vehicles, and when connected to the charging unit, has an emergency lighting function.

	IECEX / ATEX					
Zone	0	1	2	20	21	22
Installation in		•	•		•	•







Selection Table						
Ex version	Yes					
Battery-Version	Lead-fleece battery, Maintenance-free, 6 V, 4.5 Ah					
Approval for motor vehicles	E1 10 R - 036569					
Figure	Product Description	Lamp	Type of connection cable	Product Type	Art. No.	Weight
	LED portable lamp	LED	-	6148/1111-101	209687	1.55 kg
	LED portable lamp Complete set	LED	Charging cable 12 to 30 V DC	6148/3111-111	268713	1.9 kg
	LED portable lamp Complete set	LED	Charging cable 110 to 240 V AC	6148/1111-111	209686	1.83 kg

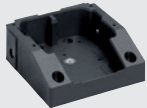

The complete set is delivered including charging unit and a charging cable for 230 V. A charging cable for 12/24 V can be ordered as accessories. The charging unit should only be used in safe areas.



The charging unit is equipped with three fastening holes for table mounting (see dimensional drawings). A wall bracket for wall mounting is available as accessories. A shoulder strap, belt hook and coloured diffusing lenses for the portable lamp are available as accessories. A clear diffusing lense is included in the delivery of the portable lamp and the complete set.

Technical Data	
Explosion Protection	
IECEX gas explosion protection	Ex ib IIC T4 Gb
IECEX dust explosion protection	Ex tb IIIC T75 °C Db
ATEX gas explosion protection	Ⓜ II 2 G Ex ib IIC T4 Gb
ATEX dust explosion protection	Ⓜ II 2 D Ex tb IIIC T75 °C Db

Technical Data	
Explosion Protection	
Certificates	ATEX (IBE), IECEx (IBE)
Class	II (double insulated)
Ambient Conditions	
Ambient temperature	-20 °C ... +50 °C
Storage temperature	-25 °C ... +60 °C
Lighting Data	
Light colour	6500 K
Light intensity	40000 cd
Light distribution	In accordance with DIN 14642
Mechanical Data	
Degree of protection (IP)	IP66
Class	II (double insulated)
Enclosure material	Polyamide, Impact resistant
Headlamp head tilting function	Front: 100°, rear: 90°
Enclosure colour	Black
Components	
Battery-Version	Lead-fleece battery, Maintenance-free, 6 V, 4.5 Ah

Accessories			
Figure	Description	Art. No.	Weight
Adaptor for external charging unit.			
	for charging the portable lamp in the KFZ90 or LG443 charging unit	212701	344 g
Belt hook			
	for fastening the portable lamp to the belt	212331	40 g
Diffusing lens			
	orange	212334	12 g
	clear	212333	14 g
	red	212956	12 g
	green	220306	13 g

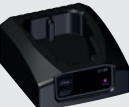
Accessories			
Figure	Description	Art. No.	Weight
Shoulder strap			
	for carrying the portable lamp	212702	50 g
Wall bracket			
	for wall mounting the charging unit	212332	260 g

Spare Parts			
Figure	Description	Art. No.	Weight
Battery			
	for 6148 lead-fleece battery, 6 V, 4.5 Ah	211124	720 g
Charging unit			
	for 6148 (12 – 30 V DC and 100 – 240 V AC)	209688	380 g
Connection cable			
	230 V charging cable with plug	120014	75 g
	12/24 V charging cable with plug	212316	22 g

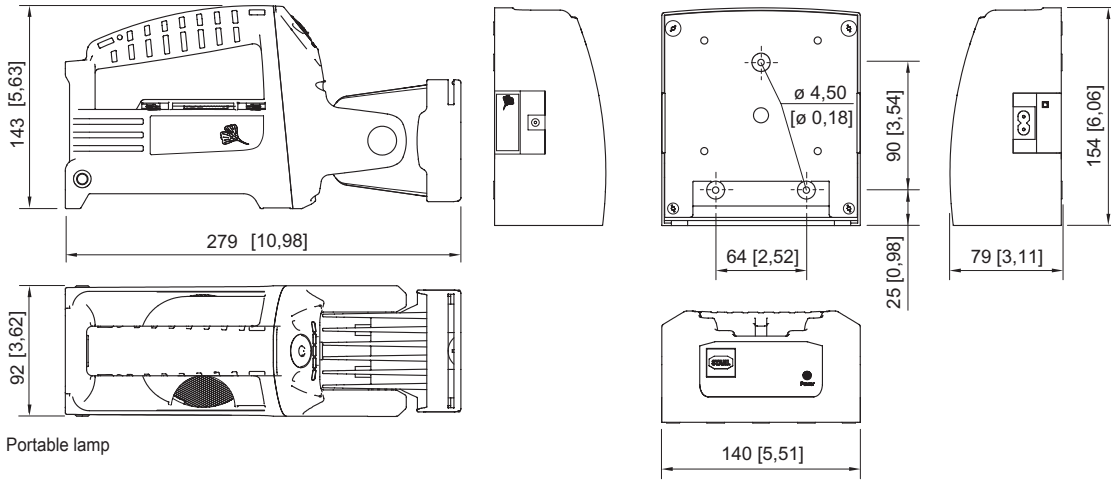

Portable lamp

Changing unit