



- Wide selection of different actuators
- Versions as NC with positive opening, NO

E4

## MY R. STAHL 8082D



R. STAHL Series 8082 contact elements have an NO contact and a positive opening NC contact, either made of silver-nickel or gold-plated. They can easily be combined to form contact blocks and enable customised installations, in part due to the wide selection of different actuators.

	IECEX / ATEX					
Zone	0	1	2	20	21	22
Installation in		•	•			

	NEC® 500 CE Code Appendix J					
Division	Class I		Class II		Class III	
Installation in	1	2	1	2	1	2
Installation in		•		•		

	CE Code Section 18					
Zone	NEC® 505 Class I			NEC® 506		
Installation in	0	1	2	20	21	22
Installation in		•	•			

Selection Table						
Contact material		Gold-plated				
Number of NCs	Number of NOs	Positive opening operation			Art. No.	Weight
1	–	Yes			273166	25 g
–	1	–			273167	25 g
Contact material		Silver-nickel				
Number of NCs	Number of NOs	Positive opening operation			Art. No.	Weight
1	–	Yes			240898	25 g
–	1	–			240899	25 g

The actuators from Series 8602/3 assemblies ASSY 001, ASSY 003, ASSY 004, ASSY 006, ASSY 008, ASSY 009, ASSY 010, ASSY 012, ASSY 014, ASSY 015, ASSY 023, ASSY 703, ASSY 726, ASSY 727 and ASSY 735 can be equipped with up to three contact elements.

The contact elements can be combined in different ways.

Technical Data		
Variant	Silver-nickel	Gold-plated
Explosion Protection		
IECEX gas explosion protection	Ex db eb IIC T6 / T5 Gb	Ex db eb IIC T6 / T5 Gb
IECEX firedamp protection	Ex db eb I Mb	Ex db eb I Mb
ATEX gas explosion protection	Ⓜ II 2 G Ex db eb IIC T6 / T5 Gb	Ⓜ II 2 G Ex db eb IIC T6 / T5 Gb
ATEX firedamp protection	Ⓜ I M2 Ex db eb I Mb	Ⓜ I M2 Ex db eb I Mb
Certificates	ATEX (PTB), Brazil (ULB), Canada (UL), China (CQST), IECEX (PTB), Korea (KTL), USA (UL)	ATEX (PTB), Brazil (ULB), Canada (UL), China (CQST), IECEX (PTB), Korea (KTL), USA (UL)
Notes	Product label may vary. Series devices are labelled with ATEX, IECEX, NEC and CE Code.	
Electrical Data		
Max. rated operational voltage	550 V	550 V

Technical Data		
Variant	Silver-nickel	Gold-plated
<b>Electrical Data</b>		
Min. rated operational voltage	24 V	24 V
Rated operational current	150 mA / 10 A	10 mA / 150 A
Rated operational current note	- Gold-plated contacts: 10 to 150 mA switching current - Silver-nickel contacts for a switching current of 150 mA and above - We recommend using 8082 snap-action switches for corrosive environments and offshore applications.	- Gold-plated contacts: 10 to 150 mA switching current - Silver-nickel contacts for a switching current of 150 mA and above - We recommend using 8082 snap-action switches for corrosive environments and offshore applications.
Electrical service life	10 <sup>6</sup> operating cycles	10 <sup>6</sup> operating cycles
Mechanical service life	10 <sup>6</sup> operating cycles	10 <sup>6</sup> operating cycles
Switching capacity AC-12	250 V / 10 A 400 V / 7.5 A 550 V / 5 A	
Switching capacity AC-15	110 V / 10 A 250 V / 6 A 400 V / 4 A	
Switching capacity DC-13	110 V / 1 A	
Switching capacity DC-13<SoftReturn/>2 contact elements in series	60 V/6 A 110 V/2.5 A 250 V/1.25 A	
<b>Ambient Conditions</b>		
Ambient temperature	-60 °C ... +70 °C (T6) -60 °C ... +85 °C (T5)	-60 °C ... +70 °C (T6) -60 °C ... +85 °C (T5)
Ambient temperature	-76 °F ... +158 °F (T6) -76 °F ... +185 °F (T5)	-76 °F ... +158 °F (T6) -76 °F ... +185 °F (T5)
Ambient temperature NEC <sup>®</sup>	-60 °C ... +75 °C (T6) -60 °C ... +90 °C (T5)	-60 °C ... +75 °C (T6) -60 °C ... +90 °C (T5)
Ambient temperature NEC <sup>®</sup>	-76 °F ... +167 °F (T6) -76 °F ... +194 °F (T5)	-76 °F ... +167 °F (T6) -76 °F ... +194 °F (T5)
Operating temperature	-60 °C ... +100 °C	-60 °C ... +100 °C
Operating temperature	-76 °F ... +212 °F	-76 °F ... +212 °F
Operating temperature NEC	-60 °C ... +95 °C	-60 °C ... +95 °C
Operating temperature NEC	-76 °F ... +203 °F	-76 °F ... +203 °F
Notes	Group installation: Installation conditions influence the ambient temperature	
<b>Mechanical Data</b>		
Degree of protection (IP) (IEC 60529)	IP20	IP20
Enclosure material	Polyamide	Polyamide
Silicone-free	Yes	Yes
Solid connection cross section	0.32 – 2.5 mm <sup>2</sup>	0.32 – 2.5 mm <sup>2</sup>
Connection cross-section AWG single stranded	22 AWG to 14 AWG	22 AWG to 14 AWG
Finely stranded connection cross section	0.32 – 2.5 mm <sup>2</sup>	0.32 – 2.5 mm <sup>2</sup>
Finely stranded connection cross-section AWG	22 AWG to 14 AWG	22 AWG to 14 AWG
Connection cross-section, finely stranded with core end sleeve	0.32 – 2.5 mm <sup>2</sup>	0.32 – 2.5 mm <sup>2</sup>
Connection cross-section, finely stranded with core end sleeve AWG	AWG22 - AWG14	AWG22 - AWG14
<b>Mounting / Installation</b>		
Tightening torque	1.2 Nm	1.2 Nm
Tightening torque lbf in	10.62 lbf in	10.62 lbf in
Connection type	Screw terminal	Screw terminal

Accessories			
Figure	Description	Art. No.	Weight
<b>Pushbutton BG001</b>			
	Ø 39 mm Black Designation plate: Black, blank disc without text Silicone-free: Yes	223691	34 g
	Ø 39 mm Black Designation plate: Black, blank disc without text Silicone-free: No	223692	34 g
<b>Mushroom pushbutton, black BG003</b>			
	Ø 39 mm Black Designation plate: Black, blank disc without text Silicone-free: Yes	244563	50 g
	Ø 39 mm Black Designation plate: Black, blank disc without text Silicone-free: No	244564	50 g
<b>Mushroom pushbutton, red BG004</b>			
	Ø 39 mm Red/black Designation plate: Red, blank disc without text Silicone-free: Yes	244565	50 g
	Ø 39 mm Red/black Designation plate: Red, blank disc without text Silicone-free: No	244566	50 g
<b>Mushroom stay-put button with key BG006</b>			
	Ø 39 mm Red/black Closing: MS1 Silicone-free: Yes	223695	75 g
	Ø 39 mm Red/black Closing: MS1 Silicone-free: No	223696	75 g
<b>Key-operated switch actuator BG008</b>			
	Ø 39 mm Black Closing: MS1 Number of switching positions: 2 Switching function: Latching / Latching Silicone-free: No	244574	50 g
	Ø 39 mm Black Closing: MS1 Number of switching positions: 3 Switching function: Latching / Latching / Latching Silicone-free: No	244633	50 g
<b>Mushroom stay-put button with EM-STOP key BG009</b>			
	Ø 39 mm Yellow/red Designation plate: With yellow backing plate Closing: MS1 Silicone-free: Yes	223693	75 g
	Ø 39 mm Yellow/red Designation plate: With yellow backing plate Closing: MS1 Silicone-free: No	223694	75 g

Accessories			
Figure	Description	Art. No.	Weight
<b>Mushroom stay-put button EM-STOP BG010</b>			
	Ø 39 mm Yellow/red Designation plate: With yellow backing plate Silicone-free: Yes	223697	50 g
	Ø 39 mm Yellow/red Designation plate: With yellow backing plate Silicone-free: No	223698	50 g
<b>Mushroom stay-put button, black BG012</b>			
	Ø 39 mm Black Silicone-free: Yes	223699	50 g
	Ø 39 mm Black Silicone-free: No	223700	50 g
<b>Mushroom pushbutton, 55 mm, red BG014</b>			
	Ø 55 mm Black/red Designation plate: Red, blank disc without text Silicone-free: Yes	244634	55 g
	Ø 55 mm Black/red Designation plate: Red, blank disc without text Silicone-free: No	244635	55 g
<b>Mushroom stay-put button, 55 mm, EM-STOP BG015</b>			
	Ø 55 mm Yellow/red Designation plate: With yellow backing plate Silicone-free: Yes	244636	55 g
<b>Mushroom stay-put button 55 mm EM-STOP BG015</b>			
	Ø 55 mm Yellow/red Designation plate: With yellow backing plate Silicone-free: No	244637	55 g
<b>Twin pushbutton BG023</b>			
	Black Silicone-free: Yes	244638	45 g
	Black Silicone-free: No	244639	45 g
<b>Mushroom pushbutton, 55 mm, black BG703</b>			
	Ø 55 mm Black Designation plate: Black, blank disc without text Silicone-free: Yes	244642	55 g
	Ø 55 mm Black Designation plate: Black, blank disc without text Silicone-free: No	244643	55 g

Accessories			
Figure	Description	Art. No.	Weight
Small rotary actuator, not lockable BG726			
	Ø 39 mm Black Designation plate: 0/OFF – I/ON Number of switching positions: 2 Lockable in: Not padlockable Switching function: Latching / Latching Silicone-free: Yes	244646	40 g
Small rotary actuator, not lockable BG726			
	Ø 39 mm Black Designation plate: 0/OFF – I/ON Number of switching positions: 2 Lockable in: Not padlockable Switching function: Latching / Latching Silicone-free: No	244647	40 g
Small rotary actuator, not lockable BG726			
	Ø 39 mm Black Designation plate: I – 0 – II Number of switching positions: 3 Lockable in: Not padlockable Switching function: Latching / Latching / Latching Silicone-free: Yes	244648	40 g
	Ø 39 mm Black Designation plate: I – 0 – II Number of switching positions: 3 Lockable in: Not padlockable Switching function: Latching / Latching / Latching Silicone-free: No	244649	40 g
Rotary actuator, small, lockable BG727			
	Ø 39 mm Black Designation plate: 0/OFF – I/ON Number of switching positions: 2 Lockable in: One pos. with one lock Switching function: Latching / Latching Silicone-free: Yes	244650	40 g
	Ø 39 mm Black Designation plate: 0/OFF – I/ON Number of switching positions: 2 Lockable in: One pos. with one lock Switching function: Latching / Latching Silicone-free: No	244651	40 g
	Ø 39 mm Black Designation plate: I – 0 – II Number of switching positions: 3 Lockable in: One pos. with one lock Switching function: Latching / Latching / Latching Silicone-free: Yes	244652	40 g
	Ø 39 mm Black Designation plate: I – 0 – II Number of switching positions: 3 Lockable in: One pos. with one lock Switching function: Latching / Latching / Latching Silicone-free: No	244653	40 g

## Accessories

Figure	Description	Art. No.	Weight
Illuminated pushbutton (spring return) BG735			
	Ø 39 mm Black All colours Silicone-free: Yes	244654	35 g
	Ø 39 mm Black All colours Silicone-free: No	244655	35 g

## Spare Parts



Figure	Description	Art. No.	Weight
Mushroom stay-put button with key BG006			
	Ø 39 mm Red/black Closing: MS2 Silicone-free: Yes	270409	75 g
	Ø 39 mm Red/black Closing: MS2 Silicone-free: No	270412	75 g
	Ø 39 mm Red/black Closing: MS3 Silicone-free: Yes	270410	75 g
	Ø 39 mm Red/black Closing: MS3 Silicone-free: No	270413	75 g
	Ø 39 mm Red/black Closing: MS4 Silicone-free: Yes	270411	75 g
	Ø 39 mm Red/black Closing: MS4 Silicone-free: No	270414	75 g

Spare Parts			
Figure	Description	Art. No.	Weight
Key-operated switch actuator BG008			
	Ø 39 mm Black Closing: MS1 Number of switching positions: 2 Switching function: Latching / Latching Silicone-free: Yes	244573	50 g
	Ø 39 mm Black Closing: MS2 Number of switching positions: 2 Switching function: Latching / Latching Silicone-free: Yes	272935	60 g
	Ø 39 mm Black Closing: MS2 Number of switching positions: 2 Switching function: Latching / Latching Silicone-free: No	270418	50 g
	Ø 39 mm Black Closing: MS3 Number of switching positions: 2 Switching function: Latching / Latching Silicone-free: Yes	274089	50 g
	Ø 39 mm Black Closing: MS3 Number of switching positions: 2 Switching function: Latching / Latching Silicone-free: No	270419	50 g
	Ø 39 mm Black Closing: MS4 Number of switching positions: 2 Switching function: Latching / Latching Silicone-free: Yes	272936	60 g
	Ø 39 mm Black Closing: MS4 Number of switching positions: 2 Switching function: Latching / Latching Silicone-free: No	270420	50 g

Spare Parts

Figure	Description	Art. No.	Weight
Key-operated switch actuator BG008			
	Ø 39 mm Black Closing: MS1 Number of switching positions: 3 Switching function: Latching / Latching / Latching Silicone-free: Yes	244632	50 g
	Ø 39 mm Black Closing: MS2 Number of switching positions: 3 Switching function: Latching / Latching / Latching Silicone-free: Yes	274090	50 g
	Ø 39 mm Black Closing: MS2 Number of switching positions: 3 Switching function: Latching / Latching / Latching Silicone-free: No	270421	50 g
	Ø 39 mm Black Closing: MS3 Number of switching positions: 3 Switching function: Latching / Latching / Latching Silicone-free: Yes	274091	50 g
	Ø 39 mm Black Closing: MS3 Number of switching positions: 3 Switching function: Latching / Latching / Latching Silicone-free: No	270422	50 g
	Ø 39 mm Black Closing: MS4 Number of switching positions: 3 Switching function: Latching / Latching / Latching Silicone-free: Yes	274092	50 g
	Ø 39 mm Black Closing: MS4 Number of switching positions: 3 Switching function: Latching / Latching / Latching Silicone-free: No	270423	50 g



Spare Parts			
Figure	Description	Art. No.	Weight
<b>Mushroom stay-put button with EM-STOP key BG009</b>			
	Ø 39 mm Yellow/red Designation plate: With yellow backing plate Closing: MS2 Silicone-free: Yes	274099	750 g
	Ø 39 mm Yellow/red Designation plate: With yellow backing plate Closing: MS2 Silicone-free: No	270415	75 g
	Ø 39 mm Yellow/red Designation plate: With yellow backing plate Closing: MS3 Silicone-free: Yes	274100	750 g
	Ø 39 mm Yellow/red Designation plate: With yellow backing plate Closing: MS3 Silicone-free: No	270416	75 g
	Ø 39 mm Yellow/red Designation plate: With yellow backing plate Closing: MS4 Silicone-free: Yes	274101	750 g
	Ø 39 mm Yellow/red Designation plate: With yellow backing plate Closing: MS4 Silicone-free: No	270417	75 g
	<b>Adaptor for front installation</b>		
	8602/3 Front installation for indicator lamp series 8010/6 and contact element series 8082/3	227038	8 g
<b>Holder for front installation</b>			
	8602/3 holder for cable duct	248673	50 g

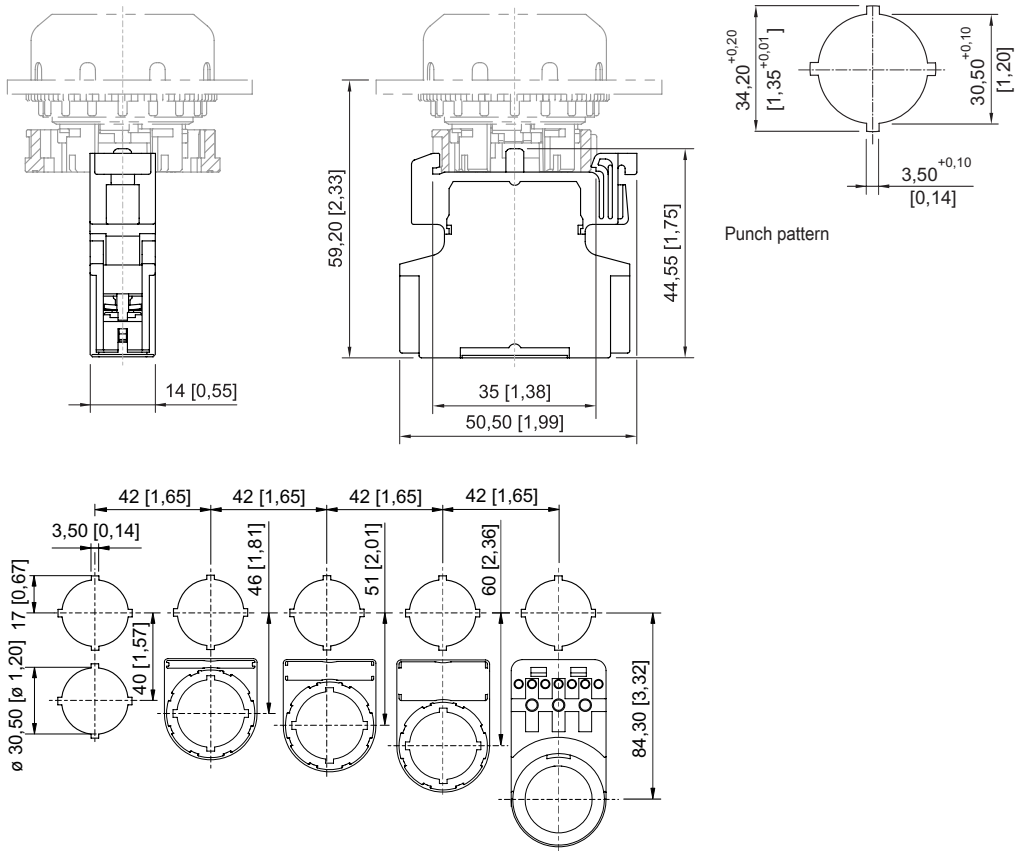

Cut-out with/without additional designation plate