



- Short delivery times
- Can be used in Zone 2 without acceptance testing or certification
- Ready for use, prefabricated with entries, BusRails, connection terminals, etc.
- Modifications, extensions and customer-specific adaptations are possible

A4

WebCode **7145F**



With the IS1+ standard enclosures for Zone 2, we offer you a variety of prefabricated field enclosures made from 1.4301 stainless steel (V2A). They include all entries, BusRails, cable ducts and connection terminals for auxiliary power.

Once the IS1+ components (available separately) have been installed, the enclosures can be used in Zone2 without acceptance testing, and they fulfil the requirements of EN 61439.

	IECEx / ATEX					
Zone	0	1	2	20	21	22
Installation in			•			

Selection Table					
Installation	Zone 2				
Dimensions (WxHxD)	Built-in unit 1	Product Type	Art. No.	Weight	
400 x 750 x 300 mm	1 x BusRail for 6 slots (1 x CPM, 5 x I/O – modules)	7145/54-0400-0750-0300	282643	25 kg	
400 x 1300 x 300 mm	1 x BusRail for 10 slots (1 x CPM, 9 x I/O – modules)	7145/54-0400-1300-0300	282461	30 kg	
600 x 600 x 230 mm	1 x BusRail for 8 slots (1 x CPM, 7 x I/O – modules)	7145/54-0600-0600-0230	260146	35 kg	
760 x 760 x 300 mm	1 x BusRail for 12 slots (1 x CPM, 11 x I/O – modules)	7145/54-0760-0760-0300	260148	55 kg	
800 x 1000 x 300 mm	1 x BusRail for 16 slots (1 x CPM, 15 x I/O – modules)	7145/54-0800-1000-0300	260149	70 kg	

Technical Data	
Explosion Protection	
IECEx gas explosion protection	Ex ec ia ib [ia Ga, ib] IIC T4 Gc
ATEX gas explosion protection	Ⓔ II 3 (1) G Ex ec ia ib [ia Ga, ib] IIC T4 Gc
Declaration of Conformity	ATEX (EUK)
Auxiliary Power	
Auxiliary power rated operating voltage	24 V DC (20 to 35 V DC)
Auxiliary power nominal current	Max. 4 A @ 24 V DC
Auxiliary power rated current	Depending on the installed IS1+ modules (see corresponding data sheet)
Ambient Conditions	
Ambient temperature	-40°C ... +55°C

Technical Data

Mechanical Data

Degree of protection (IP) (IEC 60529)	IP65
Enclosure material	Stainless steel 1.4301, (V2A, AISI 304) Brush finished

Dimensional Drawings (All Dimensions in mm [inches]) – Subject to Alterations

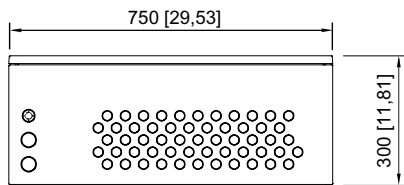
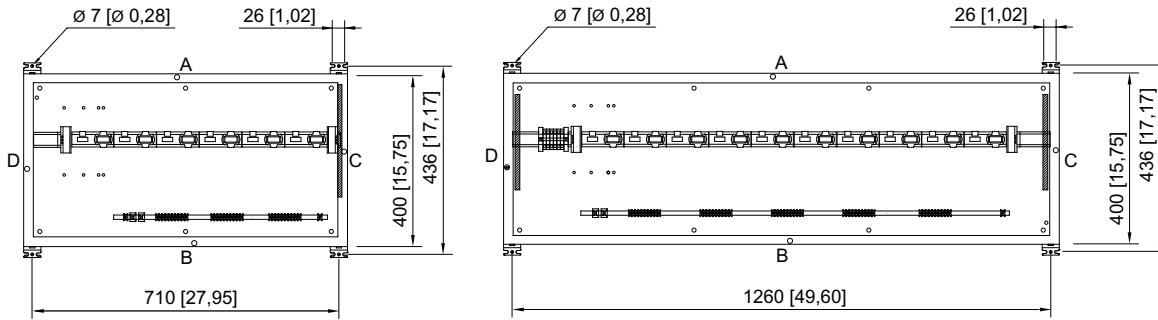

1 x BusRail for 6 slots
Item no. 282643

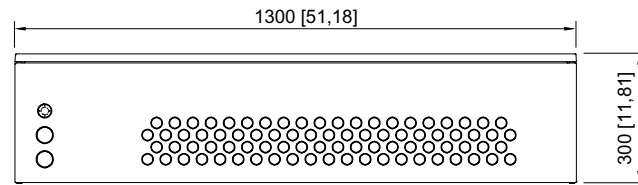

1 x BusRail for 10 slots
Item no. 282461

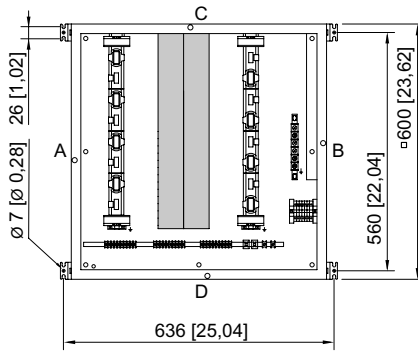

1 x BusRail for 8 slots
Item no. 260146

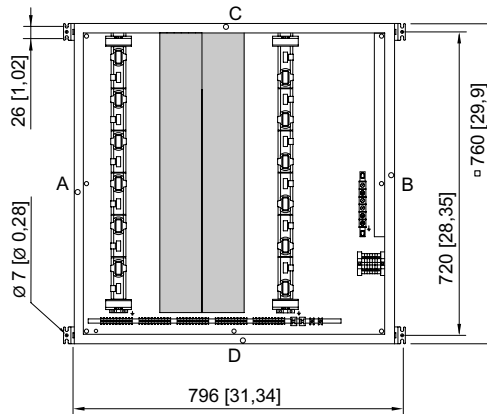

1 x BusRail for 12 slots
Item no. 260148

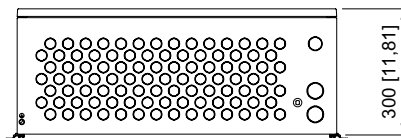
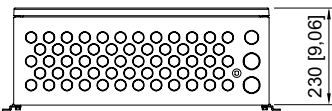

Standard enclosure Zone 2 for remote I/O

Series 7145



A4

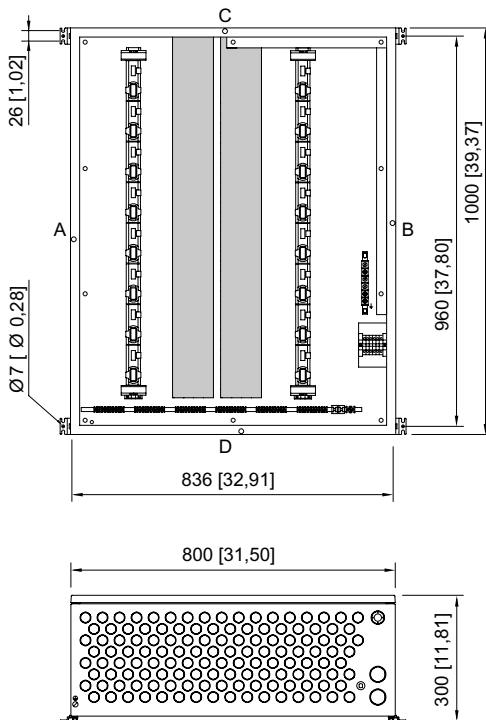

1 x BusRail for 16 slots
Item no. 260149