

EXLUX Emergency Luminaire with LED

Series 6409/4

STAHL



- The latest LED technology with a high luminous efficacy and a long service life
- Extremely high luminaire efficacy
- Can be adjusted from a 1.5 to a 3.0 h rated operating time
- Luminous flux after 100,000 h still 90% of the starting luminous flux
- Optionally with DALI for controlling and monitoring the luminaire
- Automatic weekly function test and annual rated operating time test

E2

MY R. STAHL 6409C



The emergency luminaire with Series 6409/4 LED with integrated battery can be installed in stand-by switching, continuous mode or in switchable stand-by switching. A weekly functional test and annual rated operating time test are performed automatically. The results are indicated by an LED.

		IECEX / ATEX					
Zone		0	1	2	20	21	22
Installation in				•		•	•

Selection Table									
Size		2							
Lamp wattage		25 W							
Luminaire efficacy		116 lm/W							
Luminous flux		2910 lm							
Light colour	Operating time	Ballast	Disconnection of the luminaire	Threaded plate	Drilled holes	Through wiring	Product Type	Art. No.	Weight
5000 K – neutral white	1.5 h emergency lighting operation	LED NLE 80W 110-240V/7Ah/1.5h/	Only battery	2x plastic	3 x M25	With 6 conductors 2.5 mm ²	6409/4128-5101-162-1110-11-850011	271816	5.4 kg
		LED NLE 80W 110-240V/7Ah/1.5h/	All-pole disconnection	2x plastic	3 x M25	With 6 conductors 2.5 mm ²	6409/4128-5103-162-1110-11-850011	267859	5.4 kg
		LED NLE 80W 110-240V/7Ah/1.5h/	All-pole disconnection	2x SS430 stainless steel	3 x M20	With 6 conductors 2.5 mm ²	6409/4128-5103-162-2220-22-850011	271825	5.45 kg
	3 h emergency lighting operation	LED NLE 80W 110-240V/7Ah/1.5h/	All-pole disconnection	2x plastic	3 x M25	With 8 conductors 2.5 mm ²	6409/4128-5113-182-1110-11-850011	276234	5.4 kg
		LED NLE 80W 110-240V/7Ah/3.0h/	All-pole disconnection	2x plastic	3 x M25	With 6 conductors 2.5 mm ²	6409/4128-5203-162-1110-11-850011	267860	5.4 kg
		LED NLE 80W 110-240V/7Ah/3.0h/	All-pole disconnection	2x SS430 stainless steel	3 x M20	With 6 conductors 2.5 mm ²	6409/4128-5203-162-2220-22-850011	272458	5.4 kg
Size		4							
Lamp wattage		45 W							
Luminaire efficacy		129 lm/W							
Luminous flux		5810 lm							
Light colour	Operating time	Ballast	Disconnection of the luminaire	Threaded plate	Drilled holes	Through wiring	Product Type	Art. No.	Weight
4000 K – warm neutral white	3 h emergency lighting operation	LED NLE 80W 110-240V/7Ah/3.0h/	All-pole disconnection	2x plastic	3 x M25	With 6 conductors 2.5 mm ²	6409/4148-5203-162-1110-11-840011	277319	8.1 kg

Selection Table

Size		4							
Lamp wattage		45 W							
Luminaire efficacy		129 lm/W							
Luminous flux		5810 lm							
Light colour	Operating time	Ballast	Disconnection of the luminaire	Threaded plate	Drilled holes	Through wiring	Product Type	Art. No.	Weight
5000 K – neutral white	1.5 h emergency lighting operation	LED NLE 80W 110-240V/7Ah/1.5h/	Only battery	2x plastic	3 x M25	With 6 conductors 2.5 mm ²	6409/4148-5101-162-1110-11-850011	271004	8.1 kg
		LED NLE 80W 110-240V/7Ah/1.5h/	All-pole disconnection	2x plastic	3 x M25	With 6 conductors 2.5 mm ²	6409/4148-5103-162-1110-11-850011	267861	8.1 kg
		LED NLE 80W 110-240V/7Ah/1.5h/	All-pole disconnection	2x SS430 stainless steel	3 x M20	With 6 conductors 2.5 mm ²	6409/4148-5103-162-2220-22-850011	271585	8.1 kg
	3 h emergency lighting operation	LED NLE 80W 110-240V/7Ah/3.0h/	All-pole disconnection	2x plastic	3 x M25	With 6 conductors 2.5 mm ²	6409/4148-5203-162-1110-11-850011	267862	8.1 kg
		LED NLE 80W 110-240V/7Ah/3.0h/	All-pole disconnection	2x SS430 stainless steel	3 x M20	With 6 conductors 2.5 mm ²	6409/4148-5203-162-2220-22-850011	272470	8.1 kg

Variants with 2 x threaded plate plastic and 3 x drilled holes M25:

Cable glands 2 x M25 Ø 7 -17 mm and 2 x stopping plugs M 25 x 1,5 are included loose with the product (installation required). Threaded plate included.

Variants with 2 x threaded plate stainless steel SS430 and 3 x drilled holes M20:



Cable glands and stopping plugs can be ordered as accessories. Threaded plate included.

The light fittings are supplied without mounting material.

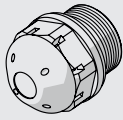
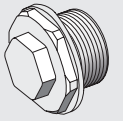
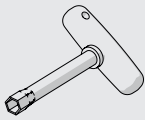
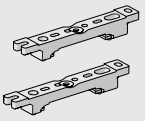
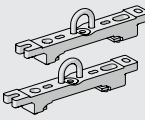

Technical Data

Variant	Size 2	Size 4
Explosion Protection		
IECEX gas explosion protection	Ex db ec IIC T4 Gc	Ex db ec IIC T4 Gc
IECEX dust explosion protection	Ex tb op is / tc IIIC T100 °C Db	Ex tb op is / tc IIIC T100 °C Db
IECEX dust explosion protection 2	Ex tc IIIC Db	Ex tc IIIC Db
ATEX gas explosion protection	⊕ II 3 G Ex db ec IIC T4 Gc	⊕ II 3 G Ex db ec IIC T4 Gc
ATEX dust explosion protection	⊕ II 2 D Ex tb op is / tc IIIC T100 °C Db	⊕ II 2 D Ex tb op is / tc IIIC T100 °C Db
ATEX dust explosion protection 2	⊕ II 2 D Ex tc IIIC Db	⊕ II 2 D Ex tc IIIC Db
Note: Through wiring	Max. 3x16 A	Max. 3x16 A
Note: Through wiring 2	Max. 3x10 A	Max. 3x10 A
Certificates	ATEX (IBE), IECEX (IBE), India (PESO)	ATEX (IBE), IECEX (IBE), India (PESO)
Declaration of Conformity	ATEX (EUK), Declaration of Conformity (AUS)	ATEX (EUK), Declaration of Conformity (AUS)
Electrical Data		
Rated operational voltage AC	110 – 240 V	110 – 240 V
Battery operating voltage	6 V	6 V
Battery capacity	7 Ah	7 Ah
Frequency range	50 – 60 Hz	50 – 60 Hz
Battery version	NiCd battery, gas-tight	NiCd battery, gas-tight
Ambient Conditions		
Ambient temperature °C	-30 – 50 °C	-30 – 50 °C
Ambient temperature	-30 °C ... +50 °C Note: Through wiring Max. 3x16 A -30 °C ... +55 °C Note: Through wiring 2 Max. 3x10 A	-30 °C ... +50 °C Note: Through wiring Max. 3x16 A -30 °C ... +55 °C Note: Through wiring 2 Max. 3x10 A
Lighting Data		
Number of lamps	1	1
Lamp	LED	LED
Light distribution	120°x120° with diffusing glass	120°x120° with diffusing glass
Colour rendering	≥ 80	≥ 80
Colour temperature	5000 K	4000 K

Technical Data		
Variant	Size 2	Size 4
Mechanical Data		
Enclosure material	Polyester resin, Glass fibre reinforced	Polyester resin, Glass fibre reinforced
Diffuser	With diffuser	With diffuser
Sealing material	Silicone	Silicone
Installed terminal strip	PE + N + L1 + L2 + L3 + L'	PE + N + L1 + L2 + L3 + L'
Max. solid connection terminals	6 mm ²	6 mm ²
Max. finely stranded connection terminals	4 mm ²	4 mm ²
Type of connection cable	Finely stranded Solid	Finely stranded Solid
Impact strength (IEC 62262)	IK10	IK10
Enclosure colour	Light grey (RAL 7035)	Light grey (RAL 7035)
Notes	Connection terminals: Spring clamp terminal (2 free clamping units per pole)	
Components		
Cable glands and entries	2 x M25 Ø 7 ...	2 x M25 Ø 7 ...
Cable entry material	Polyamide, black	Polyamide, black
Stopping plugs	2 x M25 x 1.5	2 x M25 x 1.5
Stopping plug material	Polyamide, black	Polyamide, black

Accessories			
Figure	Description	Art. No.	Weight
Breather			
	Thread: M25 x 1.5 (20 pieces); without jam nut	285780	200 g
	Thread: M25 x 1.5 (1 piece); for installation in light fittings; made from stainless steel; without jam nut	296608	-
Box spanner			
	M8 / A/F 13; For actuating the central lock	222430	110 g
Mounting rail			
	for a variable mounting distance; 1 pair	222826	350 g
Mounting bracket			
	mounting clamp mounted on a mounting rail for a variable mounting distance; 1 pair	222456	400 g
Pole mounting sleeve			
	for the subsequent mounting on lights size 2 and size 4, completely with assembly parts (for pipe diameter 42 mm)	227512	3.2 kg

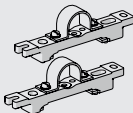
Accessories

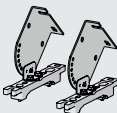
Figure	Description	Art. No.	Weight
Pipe clamp			
	R 1 1/2"; with mounting rail for a variable mounting distance; material: stainless steel; 1 pair	222459	700 g
	R 1 1/4"; with mounting rail for a variable mounting distance; Material: stainless steel; 1 pair	222458	700 g
	R 2"; with mounting rail for a variable mounting distance; Material: stainless steel; 1 pair	222460	750 g
Ring bolt			
	M8, direct mounting in insert nuts; 1 pair	115736	115 g
Ceiling and wall mounting bracket			
	mounted on a mounting rail for a variable mounting distance; Material: stainless steel; Lamp can be swiveled in steps of 15°; 1 pair	222827	1.2 kg

Spare Parts

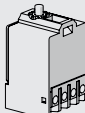
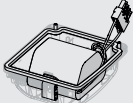
Figure	Description	Art. No.	Weight
Cover			
	for luminaire size 4	222428	1.15 kg
	for luminaire size 2	222427	639 g
Contact element			
	8080/1-3-L 2 NC contact element	132527	26 g
Battery set			
	Battery cover with built-in battery. Gas-tight NiCd battery; 7 Ah / 6 V	223532	1.2 kg

Dimensional Drawings (All Dimensions in mm [inches]) – Subject to Alterations

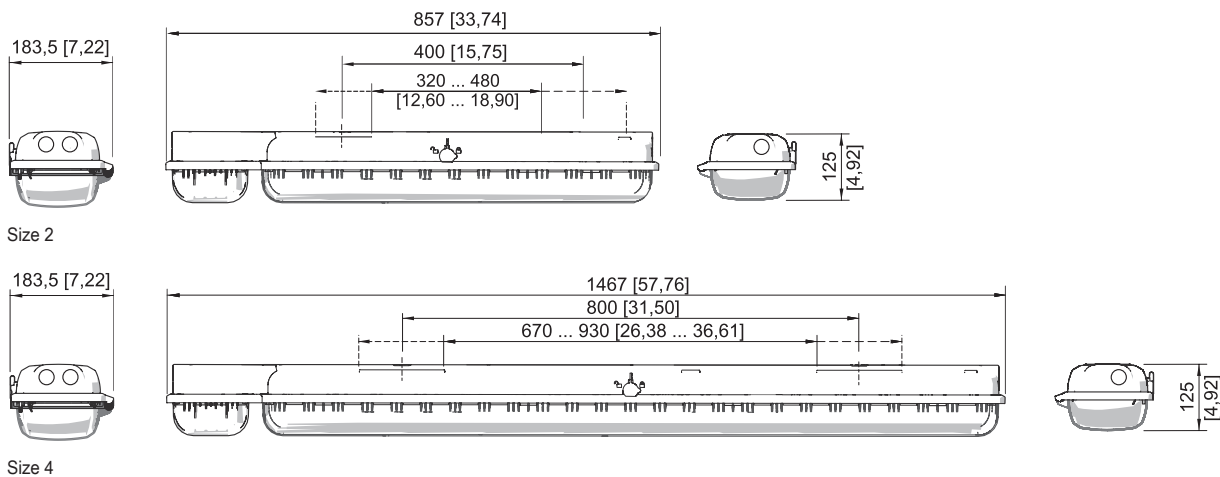

EXLUX Emergency Luminaire with LED

Series 6409/4



E2

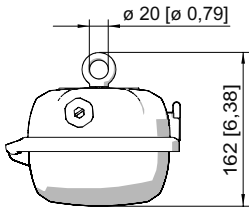

Ring bolt fitted in insert nut of the luminaire

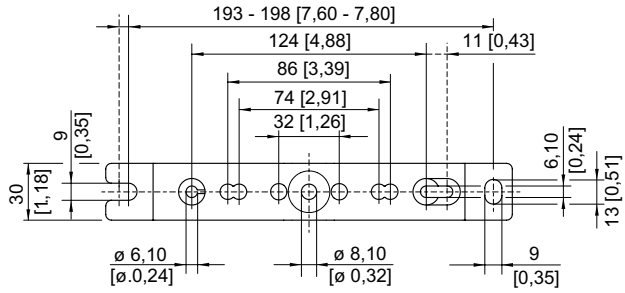
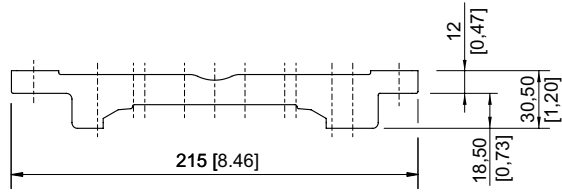

Mounting rail

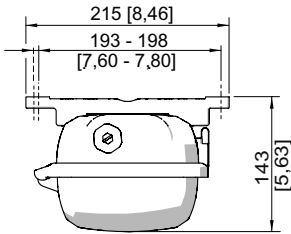

Mounting rail

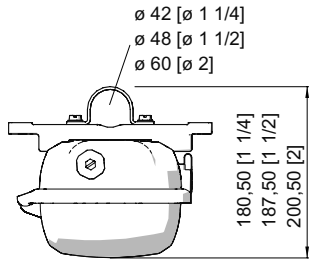

Pipe clamp fitted in mounting rail

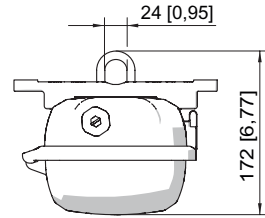

Mounting bracket fitted in mounting rail

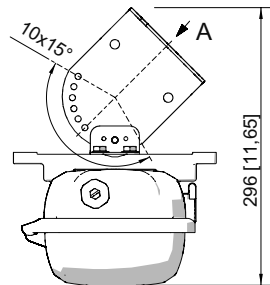

A

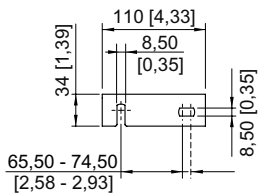

Wall mounting bracket fitted in mounting rail

E2

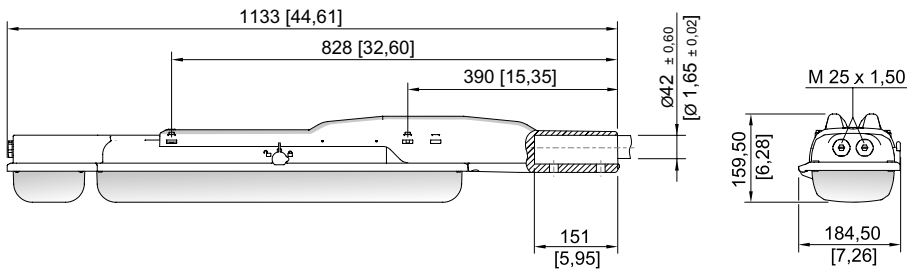

Size 2

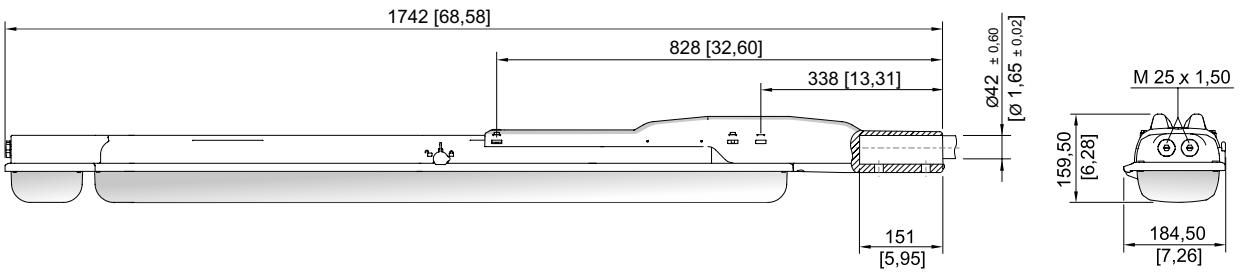

Size 4