

Control Devices

Contact element For mounting rail mounting NO

With gold-plated contacts

8082/3-11-2-1 Art. No. 275528

STAHL



- Large selection of different actuators
- Versions as an NC with positive opening, NO or disconnect terminal

MY R. STAHL 8082E



R. STAHL Series 8082 contact elements have an NO contact and a positive opening operation NC contact, made from silver-nickel or gold-plated. They can be easily combined with contact blocks and enable customised installations, also due to the large selection of the various actuators.

Technical Data

Explosion Protection

Scope of validity	European Union (ATEX) CEC IECEX NEC
Application range (zones)	1 2
IECEX gas certificate	IECEX PTB 17.0037U
IECEX gas explosion protection	Ex db eb IIC T6 / T5 Gb
IECEX firedamp certificate	IECEX PTB 17.0037U
IECEX firedamp protection	Ex db eb I Mb
ATEX gas certificate	PTB 17 ATEX 1012 U
ATEX gas explosion protection	⊕ II 2 G Ex db eb IIC T6 / T5 Gb
ATEX firedamp certificate	PTB 17 ATEX 1012 U
ATEX firedamp protection	⊕ I M2 Ex db eb I Mb
UL gas certificate	E182378V1S9
Marking cULus	Class I, Div. 2, Groups A,B,C,D; Class I, Zone 1, AEx/Ex db eb IIC
Certificates	Brazil (ULB), Canada (UL), China (CQST), IECEX (PTB), Korea (KTL), USA (UL)
Notes	Product label may vary. Series devices are labelled with ATEX, IECEX, NEC and CEC.

Electrical Data

Max. rated operational voltage	550 V
Min. rated operational voltage	24 V
Rated operational current	10 mA / 150 A
Rated operational current note	- Gold-plated contacts: 10 to 150 mA switching current - Silver-nickel contacts from 150 mA switching current. - For corrosive environments and offshore applications, we recommend the use of 8082 snap action switches.
Electrical service life	10 ⁶ operating cycles
Mechanical service life	10 ⁶ operating cycles

Control Devices

Contact element For mounting rail mounting NO

With gold-plated contacts

8082/3-11-2-1 Art. No. 275528



Ambient Conditions

Ambient temperature	-60 °C ... +70 °C (T6) -60 °C ... +85 °C (T5)
Ambient temperature	-76 °F ... +158 °F (T6) -76 °F ... +185 °F (T5)
Ambient temperature NEC®	-60 °C ... +75 °C (T6) -60 °C ... +90 °C (T5)
Ambient temperature NEC®	-76°F ... +167°F (T6) -76°F ... +194°F (T5)
Operating temperature	-60 °C ... +100 °C
Operating temperature	-76 °F ... +212 °F
Operating temperature NEC	-60 °C ... +95 °C
Operating temperature NEC	-76 °F ... +203 °F

Mechanical Data

Degree of protection (IP) (IEC 60529)	IP20
Enclosure material	Polyamide
Contact material	Gold-plated
Silicone-free	Yes
Solid connection cross section	0.32 – 2.5 mm ²
Connection cross-section AWG single stranded	22 AWG to 14 AWG
Finely stranded connection cross section	0.32 – 2.5 mm ²
Finely stranded connection cross-section AWG	22 AWG to 14 AWG
Connection cross-section, finely stranded with core end sleeve	0.32 – 2.5 mm ²
Connection cross-section, finely stranded with core end sleeve AWG	AWG22 - AWG14
Number of NOs	1
Packaging unit	1
Weight	25 g
Weight	0.055 lb

Mounting / Installation

Tightening torque	1.2 Nm
Tightening torque lbf in	10.62 lbf in
Connection type	Screw terminal

Control Devices

Contact element For mounting rail mounting NO

With gold-plated contacts

8082/3-11-2-1 Art. No. 275528



Dimensional Drawings (All Dimensions in mm [inches]) – Subject to Alterations

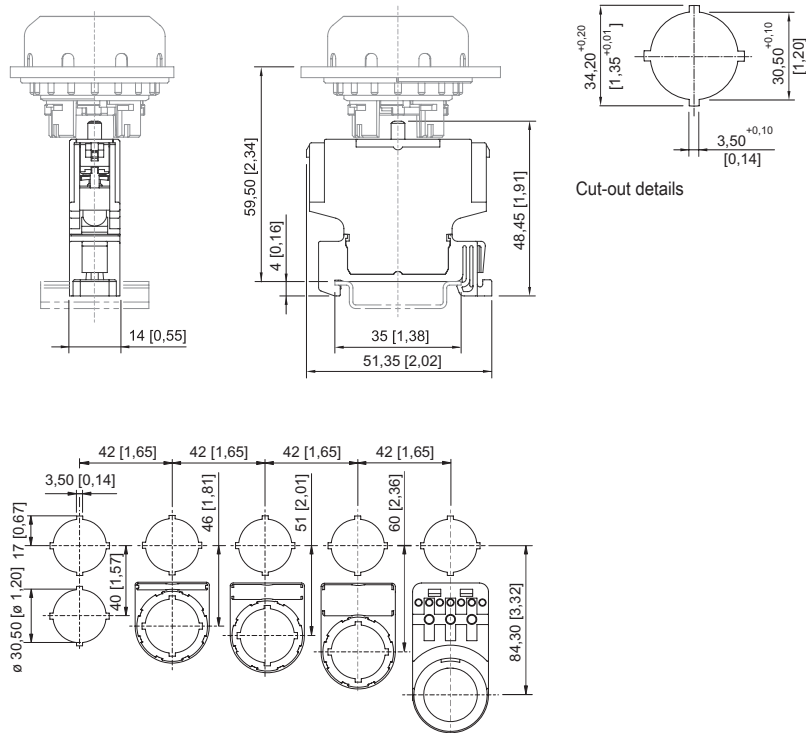

Cut-out with / without front label

Accessories

Pushbutton BG001



Ø 39 mm
Black
Designation plate: Black, blank disc without text
Silicone-free: Yes

Art. No.

223691

Ø 39 mm
Black
Designation plate: Black, blank disc without text
Silicone-free: No

223692

Mushroom pushbutton, black BG003



Ø 39 mm
Black
Designation plate: Black, blank disc without text
Silicone-free: Yes

Art. No.

244563

Ø 39 mm
Black
Designation plate: Black, blank disc without text
Silicone-free: No

244564

Control Devices

Contact element For mounting rail mounting NO

With gold-plated contacts

8082/3-11-2-1 Art. No. 275528



Mushroom pushbutton, red

		Art. No.
	Ø 39 mm Red/black Designation plate: Red, blank disc without text Silicone-free: Yes	244565
	Ø 39 mm Red/black Designation plate: Red, blank disc without text Silicone-free: No	244566



Mushroom stay-put button with key

		Art. No.
	Ø 39 mm Red/black Closing: MS1 Silicone-free: Yes	223695

Mushroom stay-put button with key

		Art. No.
	Ø 39 mm Red/black Closing: MS1 Silicone-free: No	223696

Key-operated switch actuator

		Art. No.
	Ø 39 mm Black Closing: MS1 Number of switching positions: 2 Switching function: Latching / Latching Silicone-free: No	244574
	Ø 39 mm Black Closing: MS1 Number of switching positions: 3 Switching function: Latching / Latching / Latching Silicone-free: No	244633

Mushroom stay-put button with EM-STOP key

		Art. No.
	Ø 39 mm Yellow/red Designation plate: With yellow backing plate Closing: MS1 Silicone-free: Yes	223693
	Ø 39 mm Yellow/red Designation plate: With yellow backing plate Closing: MS1 Silicone-free: No	223694

Control Devices

Contact element For mounting rail mounting NO

With gold-plated contacts

8082/3-11-2-1 Art. No. 275528

Mushroom stay-put button EM-STOP

		Art. No.
	Ø 39 mm Yellow/red Designation plate: With yellow backing plate Silicone-free: Yes	223697
	Ø 39 mm Yellow/red Designation plate: With yellow backing plate Silicone-free: No	223698

Mushroom stay-put button, black

		Art. No.
	Ø 39 mm Black Silicone-free: Yes	223699
	Ø 39 mm Black Silicone-free: No	223700

Mushroom pushbutton 55 mm red

		Art. No.
	Ø 55 mm Black/red Designation plate: Red, blank disc without text Silicone-free: Yes	244634

Mushroom pushbutton 55 mm red

		Art. No.
	Ø 55 mm Black/red Designation plate: Red, blank disc without text Silicone-free: No	244635

Mushroom stay-put button 55 mm EM-STOP

		Art. No.
	Ø 55 mm Yellow/red Designation plate: With yellow backing plate Silicone-free: Yes	244636

Mushroom stay-put button 55 mm EM-STOP

		Art. No.
	Ø 55 mm Yellow/red Designation plate: With yellow backing plate Silicone-free: No	244637

Twin pushbutton

		Art. No.
	Black Silicone-free: Yes	244638
	Black Silicone-free: No	244639

Control Devices

Contact element For mounting rail mounting NO

With gold-plated contacts

8082/3-11-2-1 Art. No. 275528



Mushroom pushbutton 55 mm black

		Art. No.
	Ø 55 mm Black Designation plate: Black, blank disc without text Silicone-free: Yes	244642
	Ø 55 mm Black Designation plate: Black, blank disc without text Silicone-free: No	244643

Small rotary actuator, not lockable

		Art. No.
	Ø 39 mm Black Designation plate: 0/OFF – I/ON Number of switching positions: 2 Lockable in: Not padlockable Switching function: Latching / Latching Silicone-free: Yes	244646
	Ø 39 mm Black Designation plate: 0/OFF – I/ON Number of switching positions: 2 Lockable in: Not padlockable Switching function: Latching / Latching Silicone-free: No	244647
	Ø 39 mm Black Designation plate: I – 0 – II Number of switching positions: 3 Lockable in: Not padlockable Switching function: Latching / Latching / Latching Silicone-free: Yes	244648
	Ø 39 mm Black Designation plate: I – 0 – II Number of switching positions: 3 Lockable in: Not padlockable Switching function: Latching / Latching / Latching Silicone-free: No	244649

Control Devices

Contact element For mounting rail mounting NO

With gold-plated contacts

8082/3-11-2-1 Art. No. 275528



Small rotary actuator, lockable

		Art. No.
	Ø 39 mm Black Designation plate: 0/OFF – I/ON Number of switching positions: 2 Lockable in: One pos. with one lock Switching function: Latching / Latching Silicone-free: Yes	244650
	Ø 39 mm Black Designation plate: 0/OFF – I/ON Number of switching positions: 2 Lockable in: One pos. with one lock Switching function: Latching / Latching Silicone-free: No	244651
	Ø 39 mm Black Designation plate: I – 0 – II Number of switching positions: 3 Lockable in: One pos. with one lock Switching function: Latching / Latching / Latching Silicone-free: Yes	244652
	Ø 39 mm Black Designation plate: I – 0 – II Number of switching positions: 3 Lockable in: One pos. with one lock Switching function: Latching / Latching / Latching Silicone-free: No	244653

Illuminated pushbutton (spring return)

		Art. No.
	Ø 39 mm Black All colours Silicone-free: Yes	244654
	Ø 39 mm Black All colours Silicone-free: No	244655

Spare Parts

Mushroom stay-put button with key

	Art. No.
--	----------

Control Devices

Contact element For mounting rail mounting NO

With gold-plated contacts

8082/3-11-2-1 Art. No. 275528



Ø 39 mm Red/black Closing: MS2 Silicone-free: Yes	270409
Ø 39 mm Red/black Closing: MS2 Silicone-free: No	270412
Ø 39 mm Red/black Closing: MS3 Silicone-free: Yes	270410
Ø 39 mm Red/black Closing: MS3 Silicone-free: No	270413
Ø 39 mm Red/black Closing: MS4 Silicone-free: Yes	270411
Ø 39 mm Red/black Closing: MS4 Silicone-free: No	270414

Control Devices

Contact element For mounting rail mounting NO

With gold-plated contacts

8082/3-11-2-1 Art. No. 275528



Key-operated switch actuator

BG008

Art. No.

		Art. No.
	Ø 39 mm Black Closing: MS1 Number of switching positions: 2 Switching function: Latching / Latching Silicone-free: Yes	244573
	Ø 39 mm Black Closing: MS2 Number of switching positions: 2 Switching function: Latching / Latching Silicone-free: Yes	272935
	Ø 39 mm Black Closing: MS2 Number of switching positions: 2 Switching function: Latching / Latching Silicone-free: No	270418
	Ø 39 mm Black Closing: MS3 Number of switching positions: 2 Switching function: Latching / Latching Silicone-free: Yes	274089
	Ø 39 mm Black Closing: MS3 Number of switching positions: 2 Switching function: Latching / Latching Silicone-free: No	270419
	Ø 39 mm Black Closing: MS4 Number of switching positions: 2 Switching function: Latching / Latching Silicone-free: Yes	272936
	Ø 39 mm Black Closing: MS4 Number of switching positions: 2 Switching function: Latching / Latching Silicone-free: No	270420

Control Devices

Contact element For mounting rail mounting NO

With gold-plated contacts

8082/3-11-2-1 Art. No. 275528



Ø 39 mm Black Closing: MS1 Number of switching positions: 3 Switching function: Latching / Latching / Latching Silicone-free: Yes	244632
Ø 39 mm Black Closing: MS2 Number of switching positions: 3 Switching function: Latching / Latching / Latching Silicone-free: Yes	274090
Ø 39 mm Black Closing: MS2 Number of switching positions: 3 Switching function: Latching / Latching / Latching Silicone-free: No	270421
Ø 39 mm Black Closing: MS3 Number of switching positions: 3 Switching function: Latching / Latching / Latching Silicone-free: Yes	274091
Ø 39 mm Black Closing: MS3 Number of switching positions: 3 Switching function: Latching / Latching / Latching Silicone-free: No	270422
Ø 39 mm Black Closing: MS4 Number of switching positions: 3 Switching function: Latching / Latching / Latching Silicone-free: Yes	274092
Ø 39 mm Black Closing: MS4 Number of switching positions: 3 Switching function: Latching / Latching / Latching Silicone-free: No	270423

Control Devices

Contact element For mounting rail mounting NO

With gold-plated contacts

8082/3-11-2-1 Art. No. 275528



Mushroom stay-put button with EM-STOP key

BG009		Art. No.
	Ø 39 mm Yellow/red Designation plate: With yellow backing plate Closing: MS2 Silicone-free: Yes	274099
	Ø 39 mm Yellow/red Designation plate: With yellow backing plate Closing: MS2 Silicone-free: No	270415
	Ø 39 mm Yellow/red Designation plate: With yellow backing plate Closing: MS3 Silicone-free: Yes	274100
	Ø 39 mm Yellow/red Designation plate: With yellow backing plate Closing: MS3 Silicone-free: No	270416
	Ø 39 mm Yellow/red Designation plate: With yellow backing plate Closing: MS4 Silicone-free: Yes	274101
	Ø 39 mm Yellow/red Designation plate: With yellow backing plate Closing: MS4 Silicone-free: No	270417

We reserve the right to make alterations to the technical data, dimensions, weights, designs and products available without notice. The illustrations cannot be considered binding.