



- The latest LED technology with a high luminous efficacy and a long service life
- Extremely high luminaire efficacy
- Can be adjusted from a 1.5 to a 3.0 h rated operating time
- Luminous flux after 100,000 h still 90% of the starting luminous flux
- Optionally with DALI for controlling and monitoring the luminaire
- Automatic weekly function test and annual rated operating time test

MY R. STAHL 6409C



The emergency luminaire with Series 6409/4 LED with integrated battery can be installed in stand-by switching, continuous mode or in switchable stand-by switching. A weekly functional test and annual rated operating time test are performed automatically. The results are indicated by an LED.

Technical Data

Explosion Protection

Ex version	Yes
Application range (zones)	2 21 22
IECEX gas certificate	IECEX IBE 16.0047
IECEX gas explosion protection	Ex db ec IIC T4 Gc
IECEX dust certificate	IECEX IBE 16.0047
IECEX dust explosion protection	Ex tb op is / tc IIIC T100 °C Db
ATEX gas certificate	IBExU 16 ATEX 1233
ATEX gas explosion protection	⊕ II 3 G Ex db ec IIC T4 Gc
ATEX dust certificate	IBExU 16 ATEX 1233
ATEX dust explosion protection	⊕ II 2 D Ex tb op is / tc IIIC T100 °C Db
Certificates and approvals	ATEX IECEX
Certificates	ATEX (IBE), IECEX (IBE), India (PESO)
Declaration of Conformity	ATEX (EUK), Declaration of Conformity (AUS)

Electrical Data

Rated operational voltage AC	110 – 240 V
Interfaces	DALI
Battery version	NiCd battery, gas-tight
Battery operating voltage	6 V
Battery capacity	7 Ah
Self-test function	With (standard)
Frequency range	50 – 60 Hz

Lighting Data

Number of lamps	1
Lamp wattage	25 W
Lamp	LED

Lighting

Emergency luminaire With LED

GRP

6409/4128-5113-182-1110-11-850011 Art. No. 276234



Lighting Data

Light colour	5000 K – neutral white
Light distribution	120°x120° with diffusing glass
Luminaire efficacy	116 lm/W
Luminous flux	2910 lm
Operating time	1.5 h emergency lighting operation
Emergency light output	65% – 1.5 h
Colour rendering	≥ 80
Colour temperature	5000 K

Ambient Conditions

Ambient temperature	-30 °C ... +50 °C Note: Through wiring Max. 3x16 A -30 °C ... +55 °C Note: Through wiring 2 Max. 3x10 A
---------------------	--

Mechanical Data

Version	Standard
IP degree of protection (IEC 60598)	IP66/IP67
Enclosure material	Polyester resin, Glass fibre reinforced
Enclosure colour	Light grey (RAL 7035)
Diffuser	With diffuser
Sealing material	Silicone
Silicone-free content	Contains silicone
Translucent cover material	Polycarbonate
Installed terminal strip	PE+N+L1+L2+L3+L"+D1+D2
Max. solid connection terminals	6 mm ²
Max. finely stranded connection terminals	4 mm ²
Type of connection cable	Finely stranded Solid
Size	2
Width	183.5 mm
Height	125 mm
Length	857 mm
Impact strength (IEC 62262)	IK10
Weight	5.4 kg
Weight	11.9 lb
Disconnection of the luminaire	All-pole disconnection

Components

Threaded plate	2x plastic
Ballast	LED NLE 80W 110-240V/7Ah/1.5h/
Through wiring	With 8 conductors 2.5 mm ²
Drilled holes	3 x M25
Cable glands and entries	2 x M25 Ø 7 ...
Material cable gland	Polyamide, black
Stopping plugs	2 x M25 x 1.5
Stopping plug material	Polyamide, black
Cable entry material	Polyamide, black
Accessories	Provided

Lighting

Emergency luminaire With LED

GRP

6409/4128-5113-182-1110-11-850011 Art. No. 276234



Dimensional Drawings (All Dimensions in mm [inches]) – Subject to Alterations

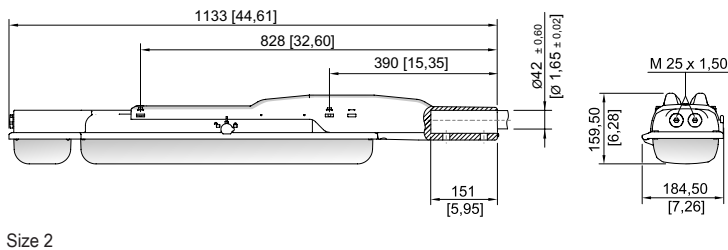
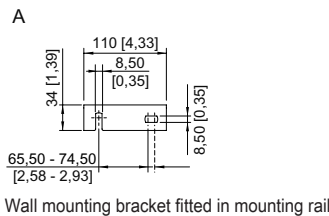
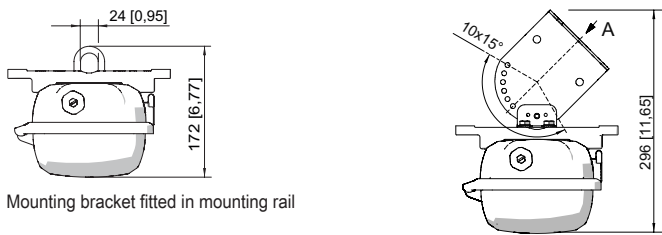
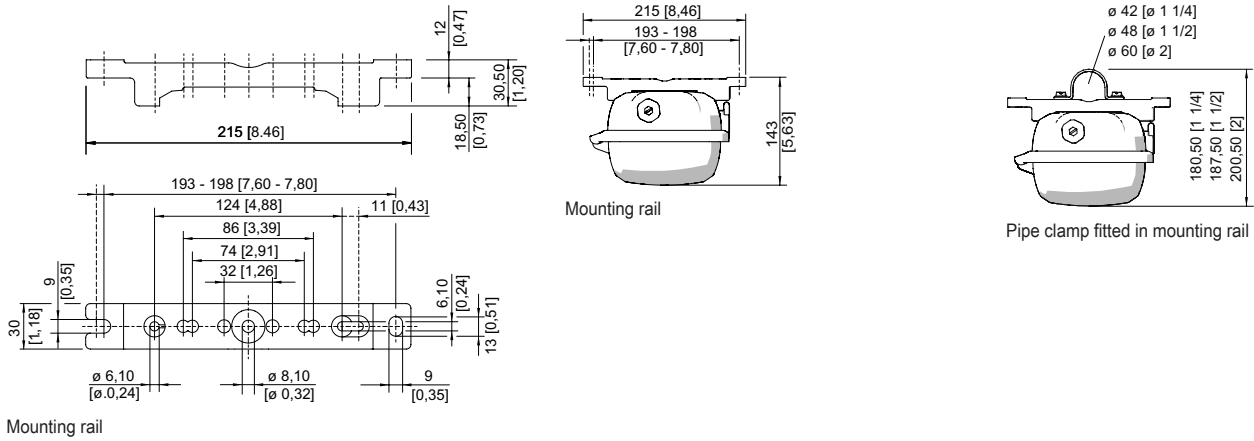
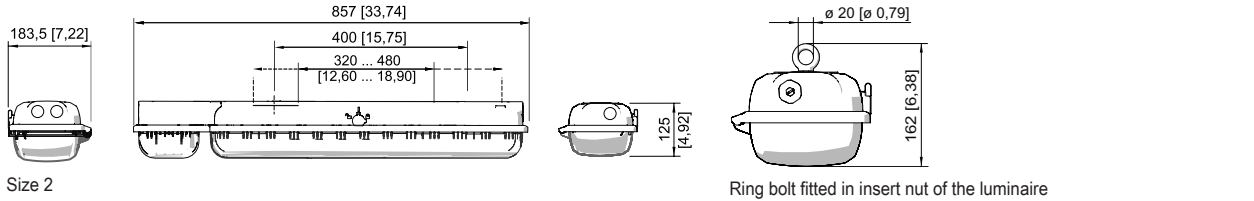

Accessories

Breather

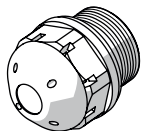

Thread: M25 x 1.5 (20 pieces); without jam nut

Art. No.

285780





Lighting

Emergency luminaire With LED

GRP

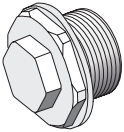
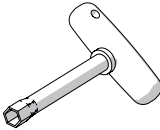
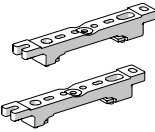
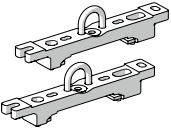
6409/4128-5113-182-1110-11-850011 Art. No. 276234

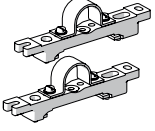

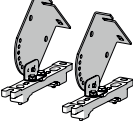
	Thread: M25 x 1.5 (1 piece); for installation in light fittings; made from stainless steel; without jam nut	296608
Box spanner		Art. No.
	M8 / A/F 13; For actuating the central lock	222430
Mounting rail		Art. No.
	for a variable mounting distance; 1 pair	222826
Mounting bracket		Art. No.
	mounting clamp mounted on a mounting rail for a variable mounting distance; 1 pair	222456
Pole mounting sleeve		Art. No.
	for the subsequent mounting on lights size 2 and size 4, completely with assembly parts (for pipe diameter 42 mm)	227512
Pipe clamp		Art. No.
	R 1 1/2"; with mounting rail for a variable mounting distance; material: stainless steel; 1 pair	222459
	R 1 1/4"; with mounting rail for a variable mounting distance; Material: stainless steel; 1 pair	222458
	R 2"; with mounting rail for a variable mounting distance; Material: stainless steel; 1 pair	222460
Ring bolt		Art. No.
	M8, direct mounting in insert nuts; 1 pair	115736
Ceiling and wall mounting bracket		Art. No.
	mounted on a mounting rail for a variable mounting distance; Material: stainless steel; Lamp can be swiveled in steps of 15°; 1 pair	222827

Spare Parts

Contact element	Art. No.
------------------------	-----------------

Lighting

Emergency luminaire With LED

GRP

6409/4128-5113-182-1110-11-850011 Art. No. 276234

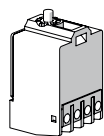

8080/1-3-L 2 NC contact element

132527

Battery set

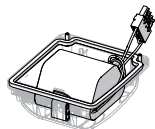

Battery cover with built-in battery. Gas-tight NiCd battery; 7 Ah / 6 V

Art. No.

223532

We reserve the right to make alterations to the technical data, dimensions, weights, designs and products available without notice. The illustrations cannot be considered binding.