

Installation equipment

Large rotary actuator Maxi

Red - yellow



8602C3-737-B-XXX-E99 Art. No. 276672



- Pushbutton, mushroom pushbutton, mushroom stay-put button with key lock, mushroom stay-put button, twin pushbutton and illuminated pushbutton, rotary actuator, key-operated switch, potentiometer bezel and indicator lamp bezel
- One axial actuator can actuate up to four Series 8082 contact elements
- Key-operated switches and rotary switches codable at any time as "latching/spring return" or "key not removable"

MY R. STAHL 8602A



Thanks to their special technical features, the actuators from the 8602/3 series can withstand the most extreme conditions. In addition to the application option for use in ambient temperatures from -60 °C to +70 °C, the IP degree of protection, IP66, is maintained in accordance with EN 60529. It is also possible to actuate up to four contact elements from the 8082 series with a single axial actuator from the 8602/3 series.

The coding option of the key switches and rotary switches is innovative and one-of-a-kind. Integrated coding allows you to adjust the "latching/spring return" and/or "key not removable" functions at any time without additional accessories. A versatile set of accessories consisting of label holders and locking devices is available.

Technical Data

Explosion Protection

Application range (zones)	1 2 21 22
IECEX gas certificate	IECEX PTB 13.0047U
IECEX gas explosion protection	Ex eb IIC Gb
IECEX dust certificate	IECEX PTB 13.0047 U
IECEX dust explosion protection	Ex tb IIIC Db
ATEX gas certificate	PTB 13 ATEX 1019 U
ATEX gas explosion protection	Ex II 2 G Ex eb IIC Gb
ATEX dust certificate	PTB 13 ATEX 1019 U
ATEX dust explosion protection	Ex II 2 D Ex tb IIIC Db
UL gas certificate	E182378 V4 S2
Inmetro gas certificate	UL-BR 14.0380U
Inmetro dust certificate	UL-BR 14.0380U
Certificates	ATEX (PTB), IECEX (PTB), India (PESO), Korea (KGS)

Ambient Conditions

Ambient temperature	-20 °C ... +60 °C
Ambient temperature	-4 °F ... +140 °F
Storage temperature	-25 °C ... +60 °C
Storage temperature	-13 °F ... +140 °F
Use at the height of	< 2000 m
Degree of contamination	3

Installation equipment

Large rotary actuator Maxi

Red - yellow



8602C3-737-B-XXX-E99 Art. No. 276672

Mechanical Data

Version	Maxi
Degree of protection (IP)	IP66
Note on degree of protection	According to IEC/EN 60529
Enclosure material	Polyamide
Silicone-free	Yes
Assembly	737
Diameter	64 mm
Service life, min.	10 ⁵ actuations
Impact strength (IEC 60079)	7 J
Impact strength (IEC 62262)	min. IK08
Handle colour	Red
Protective collar colour	Yellow
Fastening	Thread type
Designation plate	Multiple labels
Seal	Standard
Lockable in	xx° not defined
Packaging unit	1
Weight	70 g
Weight	0.15 lb
Decription note	Lockable option (max. 3 times) can be determined using the enclosed closing parts. Lockable handle position: Not defined. In the unmounted assemblies, the standard label is 0/OFF-I/ON; 0-EIN; AUS-AUTO-EIN; AUTO-0-BETRIEB-I and the long coupling part is enclosed. Other labels must be ordered separately.

Mounting / Installation

Mounting type	Pre-installed
Tightening torque	3 Nm
Tightening torque lbf in	26.55 lbf in

Technical Drawings – Subject to Alterations

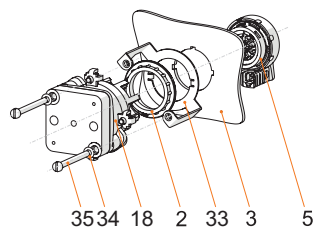

Front installation mounting with Series 8008 control switch

Key

2 = jam nut (order no. 205592)

3 = installation wall (wall thickness max. 2 mm [0.0787 inch])

5 = 8302/3 actuator with seal (4)

18 = 8008/2- control switch

33 = front installation 8602/3 adaptor for type 8008/2

34 = M4 disc

35 = M4x screw

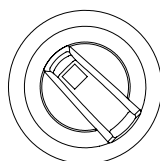

Explanation of position display:

Standard switch, lockable in 0/OFF

Position of handle 45°

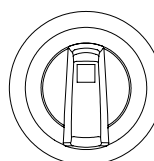

Explanation of position display:

Safety switch, lockable in I/ON

Position of handle 0°

Installation equipment

Large rotary actuator Maxi

Red - yellow



8602C3-737-B-XXX-E99 Art. No. 276672

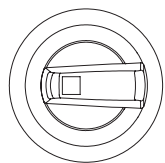

Explanation of position display:

Standard switch, lockable in 0/OFF

Position of handle 90°

Dimensional Drawings (All Dimensions in mm [inches]) – Subject to Alterations

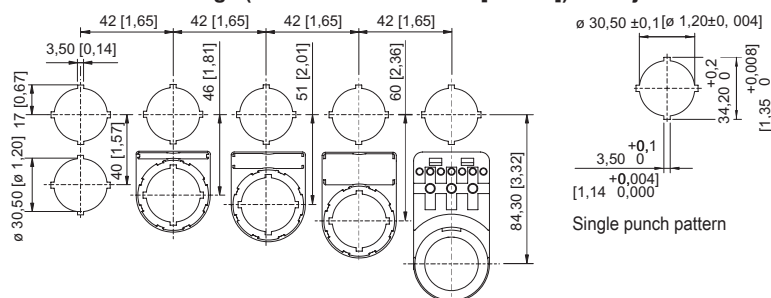

Cut-out with/without additional designation plate

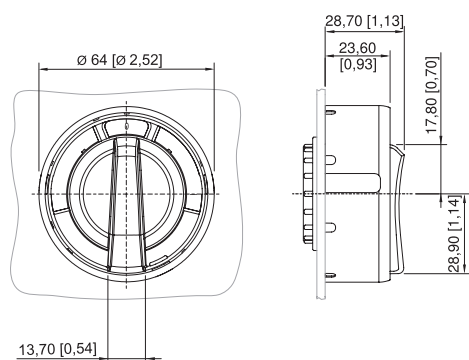

8602/3-736 maxi rotary actuator, black handle, black protective collar
 8602/3-737 maxi rotary actuator, red handle, yellow protective collar
 Actuator with radial actuation

Accessories

Cylinder lock



for closing (bracket Ø 3)

Art. No.

107115

Spare Parts

Labels for BG 736, BG 737 rotary actuator



Dia. 58.5
 0/OFF I/ON

Art. No.

274882

Installation equipment

Large rotary actuator Maxi

Red - yellow

8602C3-737-B-XXX-E99 Art. No. 276672

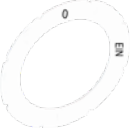
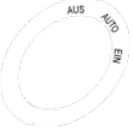
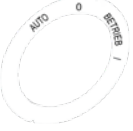

	Dia. 58.5 0 OPERATION I	263982
	Dia. 58.5 0 ON	270806
	Dia. 58.5 OFF AUTO ON	270807
	Dia. 58.5 AUTO 0 OPERATION I	270808

Special key

Art. No.

	for tightening plastic locking nut	169101
---	------------------------------------	--------

Adaptor for front installation

Art. No.

	8602/3 front installation for control switch of Series 8008	260081
--	---	--------

We reserve the right to make alterations to the technical data, dimensions, weights, designs and products available without notice. The illustrations cannot be considered binding.