

6050/604-611-7B2-208850-001 Art. No. 284229



- Extremely compact universal light fitting with 4 power classes
- Can be used as a ceiling light fitting, pendant light fitting or floodlight
- Three light distribution curves available: Ultra-wide-beam, wide-beam and medium-wide-beam
- Glare-free thanks to opaque light fitting covering
- Quick, easy installation thanks to Ex e connection chamber
- Universally suitable for use in particularly cold environments as cold as -55 °C
- Suitable for particularly high ambient temperatures up to +70 °C

MY R. STAHL 6050C



The 6050/6 universal spotlight is equipment used for lighting areas, work equipment and objects. It can be used indoors and outdoors. The clear lens is available in a matted version to limit the glare. Using an internal reflector, the universal spotlight can be adapted as a narrow beam, wide beam or a medium-wide beam to suit the lighting task.

Technical Data

Explosion Protection

| | |
|---------------------------------|---|
| Application range (zones) | 1, 2, 21, 22 |
| IECEX gas certificate | IECEX EPS 17.0093 |
| IECEX gas explosion protection | Ex db eb op is IIC T4 Gb |
| IECEX dust certificate | IECEX EPS 17.0093 |
| IECEX dust explosion protection | Ex tb op is IIIC T110 °C Db |
| ATEX gas certificate | EPS 17 ATEX 1 181 |
| ATEX gas explosion protection | Ex II 2 G Ex db eb op is IIC T4 Gb |
| ATEX dust certificate | EPS 17 ATEX 1 181 |
| ATEX dust explosion protection | Ex II 2 D Ex tb op is IIIC T110 °C Db |
| Certificates and approvals | ATEX IECEX UKEX |
| Certificates | ATEX (BVIS), Brazil (ULB), IECEX (BVIS) |
| Ship approval | DNVGL |
| Declaration of conformity | ATEX (EUK), Declaration of Conformity (AUS) |

Electrical Data

| | |
|------------------------------|--|
| Rated operational voltage AC | 220 ... 240 V |
| Rated operational voltage DC | 196 ... 250 V |
| Interfaces | DALI |
| Frequency range | 50 – 60 Hz |
| Start-up current | I _{peak} = 57 A, Delta t = 210 μs |

Lighting Data

| | |
|-----------------|------------------------|
| Number of lamps | 1 |
| Lamp wattage | 60 W |
| Lamp type | LED |
| Lamp | LED |
| Light colour | 5000 K – neutral white |

6050/604-611-7B2-208850-001 Art. No. 284229

Lighting Data

| | |
|--------------------|-------------|
| Light distribution | Medium-beam |
| Luminaire efficacy | 113 lm/W |
| Luminous flux | 6800 lm |
| Colour rendering | ≥ 80 |
| Colour temperature | 5000 K |

Ambient Conditions

| | |
|---------------------|-------------------|
| Ambient temperature | -40 °C ... +70 °C |
|---------------------|-------------------|

Mechanical Data

| | |
|---|---|
| Version | Bracket mounting |
| Degree of protection (IP) | IP66 / IP68 (10 m) |
| IP degree of protection (IEC 60598) | IP66/IP68 |
| Enclosure material | Aluminium, Seawater-resistant |
| Enclosure colour | Standard |
| Sealing material | Silicone |
| Silicone-free content | Contains silicone |
| Protective glass material 2 | Pressed glass |
| Max. solid connection terminals | 6 mm ² |
| Max. finely stranded connection terminals | 4 mm ² |
| Type of connection cable | Finely stranded Finely stranded with clip Solid |
| Size | 1 |
| Width | 298 mm |
| Height | 327.5 mm |
| Length | 310 mm |
| Reflector | Yes |
| Weight | - |
| Disconnection of the luminaire | No |

Components

| | |
|--------------------------|---------------|
| Cable glands and entries | 1 x M25 x 1.5 |
| Stopping plugs | 1 x M25 x 1.5 |
| Wire guard | Yes |

Technical Drawings – Subject to Alterations



Luminous flux decrease at ambient temperature - variants with DALI

6050/604-611-7B2-208850-001 Art. No. 284229



Luminous flux decrease at ambient temperature - variants without DALI

Light Distribution Curves

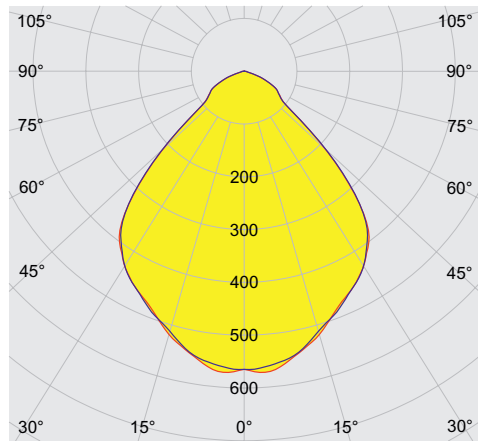

cd/klm $\eta = 100\%$
 — C0 - C180 — C90 - C270

With internal reflector, protection glass clear

Dimensional Drawings (All Dimensions in mm [inches]) – Subject to Alterations

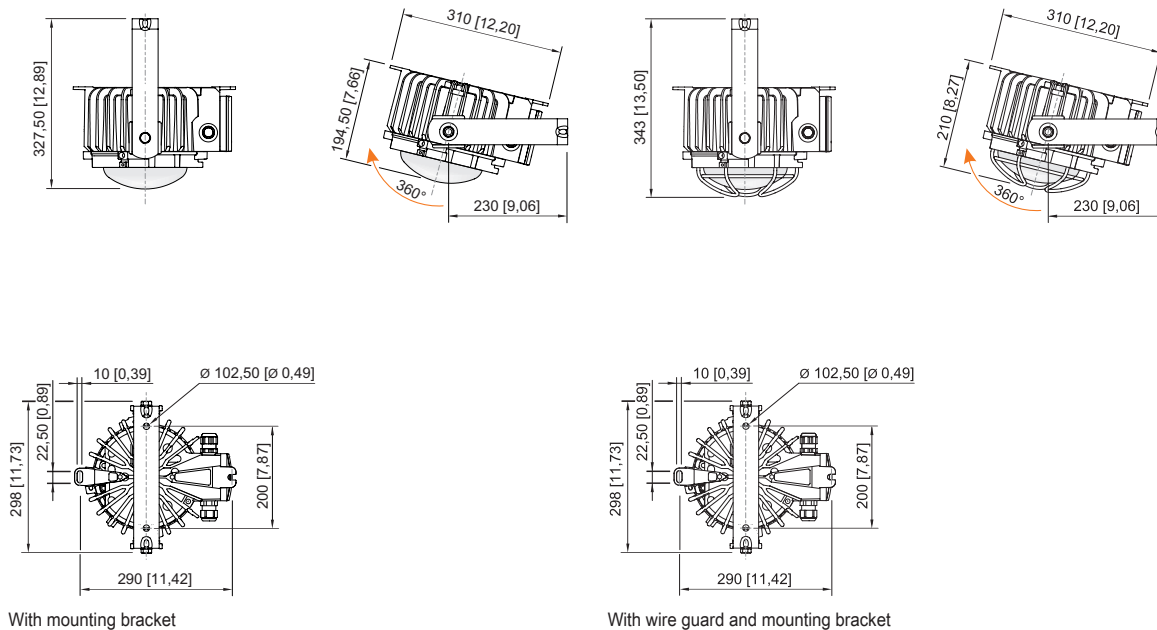

With mounting bracket



With wire guard and mounting bracket

6050/604-611-7B2-208850-001 Art. No. 284229

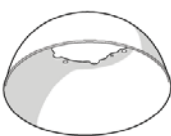

With antiglare device and mounting bracket

Accessories

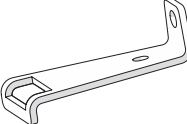
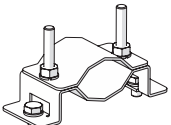

| Antiglare device / reflector | | Art. No. |
|--|---|----------|
|  | Complete with mounting parts Material: Aluminium For 6050/11 and 6050/6 | 118565 |
| External reflector | | Art. No. |
|  | Narrow-beam Complete with mounting parts Material: High-gloss anodised aluminium For 6050/11 | 118558 |
| Mounting bracket | | Art. No. |
|  | Complete; made from stainless steel (for subsequent self-mounting) For 6050/6 | 265877 |
|  | The stainless steel mounting fixture is fastened to the enclosure of the pendant light fitting series 6050/6 by means of two stainless steel screws M8. | 269716 |
| Pipe clamp | | Art. No. |
|  | for pipe R 1 1/4" to 2" | 268967 |

Lighting

LED pendant light fitting

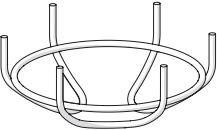

6050/604-611-7B2-208850-001 Art. No. 284229

| Plastic cable gland | | Art. No. |
|--|--|----------|
|  | 8161/7-M25-1707 7 to 17 mm ² 1 piece | 229918 |
| | 8161/7-M25-1707, Ex e Plastic, M25 x 1.5, cable outer diameter 7 to 17 mm Lot size 50 pieces | 239157 |
| Ring bolt | | Art. No. |
|  | M8, für 6050/6, direct mounting; 1 pair | 265874 |
| | M10, direct mounting in insert nuts; 1 pair | 118560 |
| Stopping plug | | Art. No. |
|  | 8290/3-M25 Plastic, M25 x 1.5 Lot size 1 piece | 143524 |
| Wire guard | | Art. No. |
|  | Complete with mounting parts Material: Stainless steel wire For 6050/6 | 221774 |

We reserve the right to make alterations to the technical data, dimensions, weights, designs and products available without notice. The illustrations cannot be considered binding.