

8595/1-CS1-S-S25-001 Art. No. 286605



- Simple handling using hot swap technology
- Versatile application possibilities thanks to modular structure
- Most extreme operating conditions in hazardous areas
- Reliable data and signal connections or power supplies
- Simple connection and disconnection thanks to one-handed operation

### MY R. STAHL 8595C



R. STAHL's Series 8595/1 explosion-protected miniCON plug connectors with up to eight poles keep you safely connected. The high-quality plastic or stainless steel plug connectors have impressed many customers with their reliability and versatility in application. Their hot swap disconnecting capacity means that intrinsically safe signal supplies and power supplies up to 500 V/16 A can be connected and disconnected reliably and safely without the need for a hot work permit or other hot work authorisation. The miniCON connectors designed for conductor cross-sections of 0.25 mm<sup>2</sup> to 2.5 mm<sup>2</sup> are available for directly connecting electrical lines or for device installation in the device plug and flange socket types of construction. The new plug connectors for hazardous areas in Zones 1 and 21 stand out from the competition thanks to their modular structure and logically arranged components, which enable quick, easy mounting. Our patented single-handed operation means that matching plug connectors, which can be defined by the installer using internal coding for up to three applications, can be connected in no time.

## Technical Data

### Explosion Protection

Area of application	European Union (ATEX) IECEX
Application range (zones)	1, 2, 21, 22
IECEX gas certificate	IECEX EPS 20.0035X
IECEX gas certificate	IECEX EPS 20.0035X
IECEX gas explosion protection	Ex db eb IIC T6 / T5 Gb
IECEX gas explosion protection 2	Ex ia IIC T6 Ga
IECEX dust certificate	IECEX EPS 20.0035X
IECEX dust explosion protection	Ex tb IIIC T80 °C / T95 °C Db
IECEX dust explosion protection 2	Ex ia IIIC T80 °C Da
ATEX gas certificate	EPS 20 ATEX 1075 X
ATEX gas certificate	EPS 20 ATEX 1075 X
ATEX gas explosion protection	⊕ II 2 G Ex db eb IIC T6 / T5 Gb
ATEX gas explosion protection 2	⊕ II 1 G Ex ia IIC T6 Ga
ATEX dust certificate	EPS 20 ATEX 1075 X
ATEX dust explosion protection	⊕ II 2 D Ex tb IIIC T80 °C / T95 °C Db
ATEX dust explosion protection 2	⊕ II 1 D Ex ia IIIC T80 °C Da
Certificates	ATEX (EPS), IECEX (EPS)
Declaration of conformity	ATEX (EUK)

8595/1-CS1-S-S25-001 Art. No. 286605

### Electrical Data

Rated operational voltage AC	500 V
Rated operational voltage DC	max. 110 V
Voltage tolerance	+10%
Rated insulation voltage	690 V
Rated operational current for AC	16 A
Rated operational current for DC	8 A
Rated operational current for DC 2	16 A
No. of poles	7
No. of poles	7 P + PE / 8 P
No. of poles note	Eight contacts are included in the delivery as standard. One to eight contacts can be used.
AC frequency range	50 – 60 Hz

### Device Specific Data

Back-up fuse with thermal protection	25 A GL
Back-up fuse without thermal protection	16 A GL

### Ambient Conditions

Ambient temperature	-60 °C ... 75 °C
Ambient temperature	-76 °F ... +167 °F

### Mechanical Data

Version	Coupling
Degree of protection (IP) (IEC 60529)	IP66 IP67
IP degree of protection (IEC 60079)	IP64
Base part	Coupling
Enclosure material	Stainless steel 1.4404
Contact type	Socket contact
Connection cross-section	2.5 mm <sup>2</sup>
Connection cross-section 2	1.5 mm <sup>2</sup>
Connection cross-section AWG	14 AWG
Connection cross-section AWG	16 AWG
Connection cross-section 2 min.	1.5 mm <sup>2</sup>
Connection cross-section 2 max.	1.5 mm <sup>2</sup>
Connection cross-section 2 AWG min.	16 AWG
Connection cross-section 2 AWG max.	16 AWG
Connection thread	M20 x 1.5
Impact strength (IEC 60079)	7 J
Coding	1-3, arbitrary
Seal	Silicone
Weight	323 g
Weight	0.71 lb

### Mounting / Installation

Connection type	crimp
Connection type 2	solder

### Components

Protective cap available	Yes
--------------------------	-----

8595/1-CS1-S-S25-001 Art. No. 286605

### Technical Drawings – Subject to Alterations

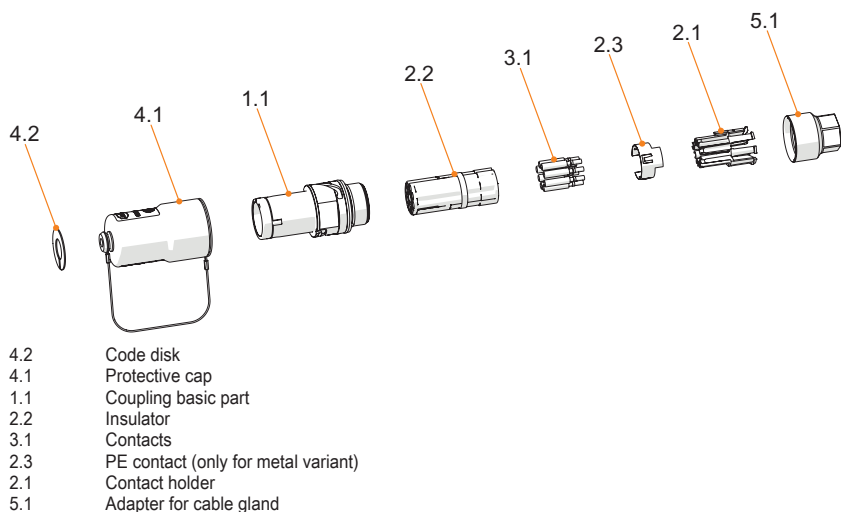

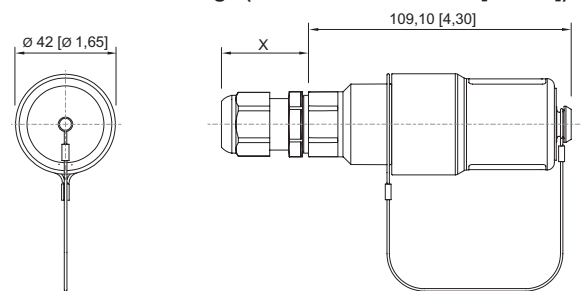

- 4.2 Code disk
- 4.1 Protective cap
- 1.1 Coupling basic part
- 2.2 Insulator
- 3.1 Contacts
- 2.3 PE contact (only for metal variant)
- 2.1 Contact holder
- 5.1 Adapter for cable gland

### Dimensional Drawings (All Dimensions in mm [inches]) – Subject to Alterations







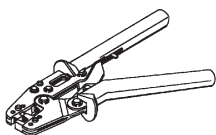
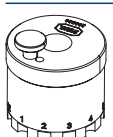

8595/1 coupling  
X = depending on the cable gland used

## Accessories

Ex e device plug	Art. No.
 <p>Enclosure material: Stainless steel 1.4404 Contact type: Pin contact Connection cross-section: 2.5 mm<sup>2</sup> Number of poles: 7 P + PE/8 P Connection type: Crimping</p>	286595
Plug	Art. No.
 <p>Enclosure material: Plastic Contact type: Pin contact Connection cross-section: 2.5 mm<sup>2</sup> Number of poles: 7 P + PE/8 P Connection type: Crimping</p>	286554
 <p>Enclosure material: Stainless steel 1.4404 Contact type: Pin contact Connection cross-section: 2.5 mm<sup>2</sup> Number of poles: 7 P + PE/8 P Connection type: Crimping</p>	286593



8595/1-CS1-S-S25-001 Art. No. 286605

<b>Crimping tool</b>		<b>Art. No.</b>
	For all versions with crimp connection of 0.14 to 6 mm <sup>2</sup>	295689
<b>Contact mounts/positioners for rotated industrial contacts</b>		<b>Art. No.</b>
	The selection of the contact mount is based on the crimp contacts to be processed. - Exact positioning of the crimp contact during the crimping process - Reliable, reproducible crimping result - Adapted for miniCON contacts	299586
<b>2-ear clamps</b>		<b>Art. No.</b>
	KIT 8595 2-ear clamps, small Strain relief depending on the cable gland used Cable outer diameter 5 to 13 mm	286168
<b>Adapters</b>		<b>Art. No.</b>
	8595 stainless steel adapter for cable gland, M16 x 1.5	314521
<b>Adaptor</b>		<b>Art. No.</b>
	KIT 8595 stainless steel adaptor for cable gland, M20 x 1.5	286164
<b>Socket contact</b>		<b>Art. No.</b>
	KIT 8595 socket contacts (2.5 mm <sup>2</sup> ), 8 pieces	286154
<b>Code disks</b>		<b>Art. No.</b>
	KIT coding plate 8595, four colours, without labelling Customer-specific labelling available on request	289939
<b>Metal cable gland</b>		<b>Art. No.</b>
	CMP type 20C2K, Ex e Stainless steel, M20 x 1.5, for armoured cables, thread length 10 mm Cable outer diameter 12.5 to 20.9 mm	309098
	CMP type 20s/16C2K, Ex e Stainless steel, M20 x 1.5, for armoured cables, thread length 10 mm Cable outer diameter 6.1 to 13.1 mm	309097

8595/1-CS1-S-S25-001 Art. No. 286605

	CMP type 20A2e100, Ex e Stainless steel, M20 x 1.5, for unarmoured cables Cable outer diameter 7 to 13.5 mm	309131
	CMP type 20s/16A2e100, Ex e Stainless steel, M20 x 1.5, for unarmoured cables Cable outer diameter 3.2 to 8 mm	309100

## Spare Parts

<b>Jam nut, nickel-plated brass</b>		<b>Art. No.</b>
	Material: Nickel-plated brass    One piece Thread size: M32	110869
<b>Contact holder for socket contact</b>		<b>Art. No.</b>
	KIT 8595 socket contact insert + PE	286146
<b>Protective cap</b>		<b>Art. No.</b>
	KIT 8595 coupling protective cap (socket) Incl. KIT 8595 coding plates, four colours, without labelling	286159

We reserve the right to make alterations to the technical data, dimensions, weights, designs and products available without notice. The illustrations cannot be considered binding.