

8595/1-CS1-S-S10-00E Art. No. 286601



- Simple handling using hot swap technology
- Versatile application possibilities thanks to modular structure
- Most extreme operating conditions in hazardous areas
- Reliable data and signal connections or power supplies
- Simple connection and disconnection thanks to one-handed operation

MY R. STAHL 8595F



R. STAHL's Series 8595/1 explosion-protected miniCON plug connectors with up to eight poles keep you safely connected. The high-quality plastic or stainless steel plug connectors have impressed many customers with their reliability and versatility in application. Their hot swap disconnecting capacity means that intrinsically safe signal supplies and power supplies up to 500 V/16 A can be connected and disconnected reliably and safely without the need for a hot work permit or other hot work authorisation. The miniCON connectors designed for conductor cross-sections of 0.25 mm² to 2.5 mm² are available for directly connecting electrical lines or for device installation in the device plug and flange socket types of construction. The new plug connectors for hazardous areas in Zones 1 and 21 stand out from the competition thanks to their modular structure and logically arranged components, which enable quick, easy mounting. Our patented single-handed operation means that matching plug connectors, which can be defined by the installer using internal coding for up to three applications, can be connected in no time.

Technical Data

Explosion Protection

Scope of validity	European Union (ATEX) IECEX
Application range (zones)	1 2 21 22
IECEX gas certificate	IECEX EPS 20.0035X
IECEX gas explosion protection	Ex db eb IIC T6 / T5 Gb
IECEX gas explosion protection 2	Ex ia IIC T6 Ga
IECEX dust certificate	IECEX EPS 20.0035X
IECEX dust explosion protection	Ex tb IIIC T80 °C / T95 °C Db
IECEX dust explosion protection 2	Ex ia IIIC T80 °C Da
ATEX gas certificate	EPS 20 ATEX 1075 X
ATEX gas explosion protection	⊕ II 2 G Ex db eb IIC T6 / T5 Gb
ATEX gas explosion protection 2	⊕ II 1 G Ex ia IIC T6 Ga
ATEX dust certificate	EPS 20 ATEX 1075 X
ATEX dust explosion protection	⊕ II 2 D Ex tb IIIC T80 °C / T95 °C Db
ATEX dust explosion protection 2	⊕ II 1 D Ex ia IIIC T80 °C Da
Certificates	ATEX (EPS), IECEX (EPS)
Declaration of Conformity	ATEX (EUK)

8595/1-CS1-S-S10-00E Art. No. 286601

Electrical Data

Rated operational voltage AC	500 V
Rated operational voltage DC	max. 110 V
Voltage tolerance	+10%
Rated insulation voltage	690 V
Rated operational current for AC	16 A
Rated operational current for DC	8 A
Rated operational current for DC 2	16 A
No. of poles	7 P + PE / 8 P
AC frequency range	50 – 60 Hz

Device Specific Data

Back-up fuse with thermal protection	25 A GL
Back-up fuse without thermal protection	16 A GL

Ambient Conditions

Ambient temperature	-60 °C ... +75 °C
Ambient temperature	-76 °F ... +167 °F

Mechanical Data

Version	Ex e flange socket
Degree of protection (IP) (IEC 60529)	IP66 IP67
IP degree of protection (IEC 60079)	IP64
Base part	Coupling
Enclosure material	Stainless steel 1.4404
Contact type	Socket contact
Connection cross-section	0.75 – 1 mm ²
Connection cross-section 2	0.34 – 0.5 mm ²
Connection cross-section AWG	AWG18
Connection cross-section AWG2	AWG22-AWG20
Connection thread	M32 x 1.5
Impact strength (IEC 60079)	7 J
Coding	1-3, arbitrary
Seal	Silicone
Weight	400 g
Weight	0.88 lb

Mounting / Installation

Connection type	crimp
Connection type 2	solder

Components

Protective cap available	Yes
--------------------------	-----

Technical Drawings – Subject to Alterations

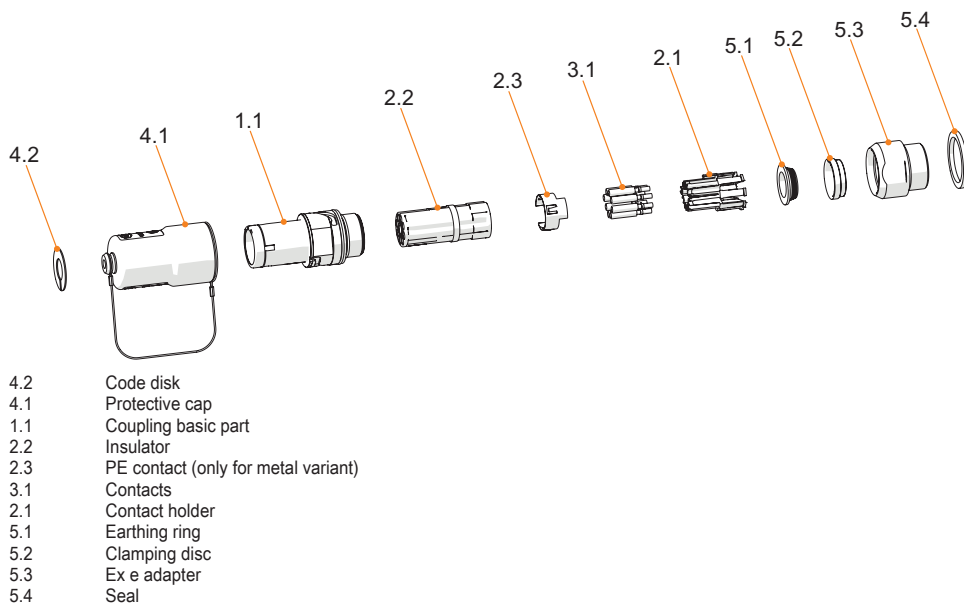

Dimensional Drawings (All Dimensions in mm [inches]) – Subject to Alterations

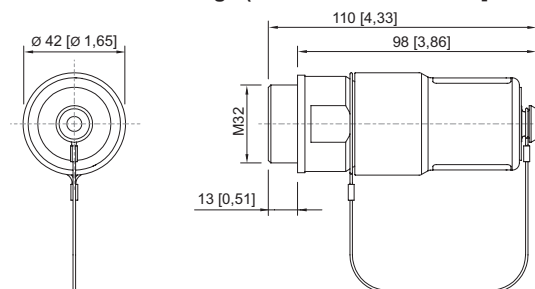

8595/1 Ex e flange socket

Accessories

EMC/shielding



To create an EMC-compliant connection of braided, shielded or reinforced conductors.

Art. No.

307512

Plug



Enclosure material: Plastic
Contact type: Pin contact
Connection cross-section: 0.75 to 1 mm²
Number of poles: 7 P + PE/8 P
Connection type: Crimping

Art. No.

286550





Enclosure material: Plastic
Contact type: Pin contact
Connection cross-section: 0.75 to 1 mm²
Number of poles: 7 P + PE/8 P
Connection type: Crimping

Art. No.

286551

8595/1-CS1-S-S10-00E Art. No. 286601

	<p>Enclosure material: Stainless steel 1.4404 Contact type: Pin contact Connection cross-section: 0.75 to 1 mm² Number of poles: 7 P + PE/8 P Connection type: Crimping</p>	286587
	<p>Enclosure material: Stainless steel 1.4404 Contact type: Pin contact Connection cross-section: 0.75 to 1 mm² Number of poles: 7 P + PE/8 P Connection type: Crimping</p>	286588

Crimping tool

Art. No.

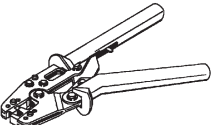
	For all versions with crimp connection of 0.14 to 6 mm ²	295689
--	---	--------

Contact mounts/positioners for rotated industrial contacts

Art. No.

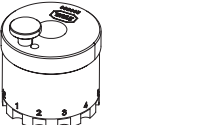
	<p>The selection of the contact mount is based on the crimp contacts to be processed.</p> <ul style="list-style-type: none"> - Exact positioning of the crimp contact during the crimping process - Reliable, reproducible crimping result - Adapted for miniCON contacts 	299586
---	--	--------

Adaptor

Art. No.

	KIT 8595 stainless steel adaptor, M20 x 1.5, for installation in Ex e enclosure	304565
	KIT 8595 stainless steel adaptor, M25 x 1.5, for installation in Ex e enclosure	304567
	KIT 8595 stainless steel adaptor, M32 x 1.5, for installation in Ex e enclosure	286166

Socket contact

Art. No.

	KIT 8595 socket contacts (0.75 to 1 mm ²), 8 pieces	286152
--	---	--------

Code disks

Art. No.

	<p>KIT coding plate 8595, four colours, without labelling Customer-specific labelling available on request</p>	289939
--	---	--------

Reducer

Art. No.

	CMP-737DR Reducer M32 x 1.5 - M20 x 1.5 Stainless steel	281583
	CMP-737DR Reducer M32 x 1.5 - M25 x 1.5 Stainless steel	281586

Spare Parts

Jam nut, nickel-plated brass (-60 to +75 °C)

To mount the cable entries in the through holes



Art. No.

Installation equipment

miniCON plug connector



8595/1-CS1-S-S10-00E Art. No. 286601

	Material: Nickel-plated brass One piece Thread size: M32	110869
Contact holder for socket contact		Art. No.
	KIT 8595 socket contact insert + PE	286146
Protective cap		Art. No.
	KIT 8595 coupling protective cap (socket) Incl. KIT 8595 coding plates, four colours, without labelling	286159

We reserve the right to make alterations to the technical data, dimensions, weights, designs and products available without notice. The illustrations cannot be considered binding.