

8595/1-CS1-S-P05-001 Art. No. 286608



- Simple handling using hot swap technology
- Versatile application possibilities thanks to modular structure
- Most extreme operating conditions in hazardous areas
- Reliable data and signal connections or power supplies
- Simple connection and disconnection thanks to one-handed operation

MY R. STAHL 8595C



R. STAHL's Series 8595/1 explosion-protected miniCON plug connectors with up to eight poles keep you safely connected. The high-quality plastic or stainless steel plug connectors have impressed many customers with their reliability and versatility in application. Their hot swap disconnecting capacity means that intrinsically safe signal supplies and power supplies up to 500 V/16 A can be connected and disconnected reliably and safely without the need for a hot work permit or other hot work authorisation. The miniCON connectors designed for conductor cross-sections of 0.25 mm² to 2.5 mm² are available for directly connecting electrical lines or for device installation in the device plug and flange socket types of construction. The new plug connectors for hazardous areas in Zones 1 and 21 stand out from the competition thanks to their modular structure and logically arranged components, which enable quick, easy mounting. Our patented single-handed operation means that matching plug connectors, which can be defined by the installer using internal coding for up to three applications, can be connected in no time.

Technical Data

Explosion Protection

Scope of validity	European Union (ATEX) IECEX
Application range (zones)	1 2 21 22
IECEX gas certificate	IECEX EPS 20.0035X
IECEX gas explosion protection	Ex db eb IIC T6 / T5 Gb
IECEX gas explosion protection 2	Ex ia IIC T6 Ga
IECEX dust certificate	IECEX EPS 20.0035X
IECEX dust explosion protection	Ex tb IIIC T80 °C / T95 °C Db
IECEX dust explosion protection 2	Ex ia IIIC T80 °C Da
ATEX gas certificate	EPS 20 ATEX 1075 X
ATEX gas explosion protection	⊕ II 2 G Ex db eb IIC T6 / T5 Gb
ATEX gas explosion protection 2	⊕ II 1 G Ex ia IIC T6 Ga
ATEX dust certificate	EPS 20 ATEX 1075 X
ATEX dust explosion protection	⊕ II 2 D Ex tb IIIC T80 °C / T95 °C Db
ATEX dust explosion protection 2	⊕ II 1 D Ex ia IIIC T80 °C Da
Certificates	ATEX (EPS), IECEX (EPS)
Declaration of Conformity	ATEX (EUK)

8595/1-CS1-S-P05-001 Art. No. 286608

Electrical Data

Rated operational voltage AC	500 V
Rated operational voltage DC	max. 110 V
Voltage tolerance	+10%
Rated insulation voltage	690 V
Rated operational current for AC	16 A
Rated operational current for DC	8 A
Rated operational current for DC 2	16 A
No. of poles	7 P + PE / 8 P
No. of poles note	Eight contacts are included in the delivery as standard. One to eight contacts can be used.
AC frequency range	50 – 60 Hz

Device Specific Data

Back-up fuse with thermal protection	25 A GL
Back-up fuse without thermal protection	16 A GL

Ambient Conditions

Ambient temperature	-60 °C ... +75 °C
Ambient temperature	-76 °F ... +167 °F

Mechanical Data

Version	Coupling, reverse
Degree of protection (IP) (IEC 60529)	IP66 IP67
IP degree of protection (IEC 60079)	IP64
Base part	Coupling
Enclosure material	Stainless steel 1.4404
Contact type	Pin contact
Connection cross-section	0.5 mm ²
Connection cross-section 2	0.25 mm ²
Connection cross-section AWG	AWG20
Connection cross-section AWG2	AWG24
Connection thread	M20 x 1.5
Impact strength (IEC 60079)	7 J
Coding	1-3, arbitrary
Seal	Silicone
Weight	323 g
Weight	0.71 lb

Mounting / Installation

Connection type	crimp
Connection type 2	solder

Components

Protective cap available	Yes
--------------------------	-----

8595/1-CS1-S-P05-001 Art. No. 286608

Technical Drawings – Subject to Alterations

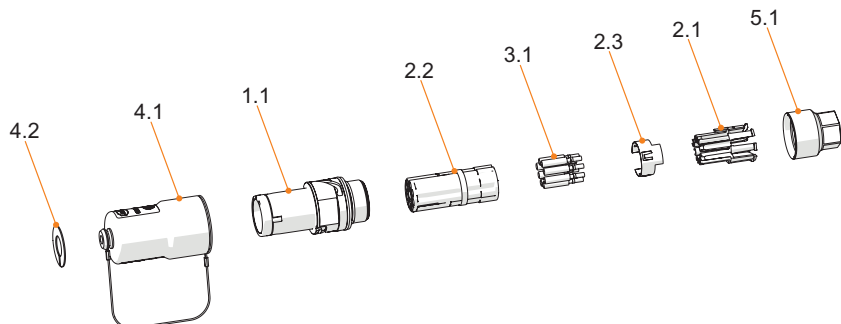

- 4.2 Code disk
- 4.1 Protective cap
- 1.1 Coupling basic part
- 2.2 Insulator
- 3.1 Contacts
- 2.3 PE contact (only for metal variant)
- 2.1 Contact holder
- 5.1 Adapter for cable gland

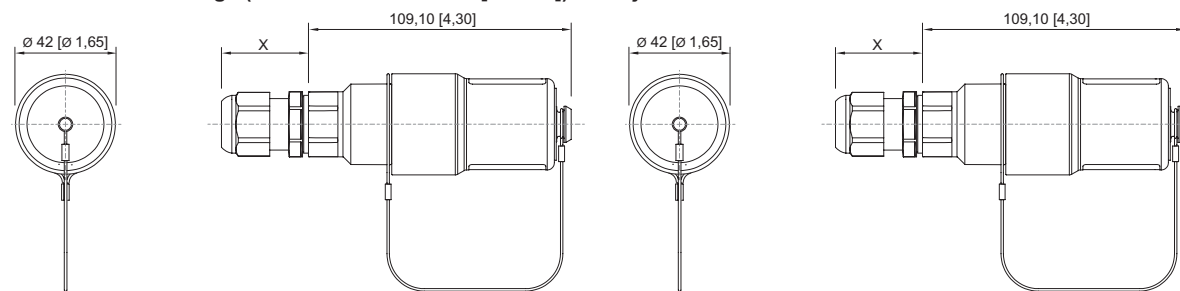

Dimensional Drawings (All Dimensions in mm [inches]) – Subject to Alterations



8595/1 coupling
X = depending on the cable gland used

8595/1 coupling
X = depending on the cable gland used

Accessories

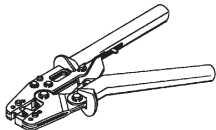
		Art. No.
	8595 stainless steel adaptor for cable gland, M16 x 1.5	314521
	Enclosure material: Stainless steel 1.4404 Contact type: Socket contact Connection cross-section: 0.5 mm ² Number of poles: 7 P + PE/8 P Connection type: Crimping	286572
	For all versions with crimp connection of 0.14 to 6 mm ²	295689

8595/1-CS1-S-P05-001 Art. No. 286608

Contact mounts/positioners for rotated industrial contacts

Art. No.

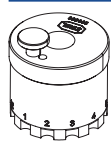

The selection of the contact mount is based on the crimp contacts to be processed.

- Exact positioning of the crimp contact during the crimping process
- Reliable, reproducible crimping result
- Adapted for miniCON contacts

299586

2-ear clamps

Art. No.

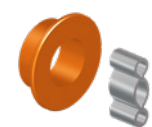

KIT 8595 2-ear clamps, small
Strain relief depending on the cable gland used
Cable outer diameter 5 to 13 mm

286168

Adaptor

Art. No.



KIT 8595 stainless steel adaptor
for cable gland, M20 x 1.5

286164

Pin contact

Art. No.



KIT 8595 pin contacts (0.25 to 0.5 mm²), 8 pieces

286155

Code disks

Art. No.



KIT coding plate 8595, four colours, without labelling
Customer-specific labelling available on request

289939

Metal cable gland

Art. No.



CMP type 20C2K, Ex e
Stainless steel, M20 x 1.5, for armoured cables, thread length 10 mm
Cable outer diameter 12.5 to 20.9 mm

309098

CMP type 20s/16C2K, Ex e
Stainless steel, M20 x 1.5, for armoured cables, thread length 10 mm
Cable outer diameter 6.1 to 13.1 mm

309097



CMP type 20A2e100, Ex e
Stainless steel, M20 x 1.5, for unarmoured cables
Cable outer diameter 7 to 13.5 mm

309131

CMP type 20s/16A2e100, Ex e
Stainless steel, M20 x 1.5, for unarmoured cables
Cable outer diameter 3.2 to 8 mm

309100

Spare Parts

Jam nut, nickel-plated brass (-60 to +75 °C)

To mount the cable entries in the through holes

Art. No.



Material: Nickel-plated brass One piece
Thread size: M32

110869

8595/1-CS1-S-P05-001 Art. No. 286608

Contact holder for pin contact

Art. No.



KIT 8595 pin contact insert + PE

286148

Protective cap

Art. No.



KIT 8595 coupling protective cap (pin)
Incl. KIT 8595 coding plates, four colours, without labelling

286160

We reserve the right to make alterations to the technical data, dimensions, weights, designs and products available without notice. The illustrations cannot be considered binding.