

Control and signalling devices

Control device system Series ConSig 8040

Pushbutton

8040/12E8X-01L12SA05 Art. No. 287018

STAHL

ConSig



- Quad certified control stations (NEC®, CE Code, ATEX, IECEX)
- Lightweight enclosure made of glass fibre reinforced polyester (FRP), excellent for corrosive atmospheres
- Offers a variety of pushbuttons, illuminated pushbuttons, control switches and LEDs for different configurations
- Customisable control stations available upon request with different entry, contact options and additional certifications

MY R. STAHL 8040E



R. STAHL's series 8040 NEC® / CE Code control stations utilize explosion-protected components with non-metallic enclosures for the ultimate flexibility, safety and durability in hazardous and hostile locations. Choose from one of the standard versions or contact us for a customised solution.

Technical Data

Explosion Protection

Area of application	European Union (ATEX) Canada IECEX USA
Application range (zones)	1, 2, 21, 22
IECEX gas certificate	IECEX PTB 06.0025
IECEX gas certificate	IECEX PTB 06.0025
IECEX gas explosion protection	Ex db eb IIC T6 Gb
IECEX dust certificate	IECEX PTB 06.0025
IECEX dust explosion protection	Ex tb IIIC T80 °C Db
ATEX gas certificate	PTB 01 ATEX 1105
ATEX gas certificate	PTB 01 ATEX 1105
ATEX gas explosion protection	⊕ II 2 G Ex db eb IIC T6 Gb
ATEX dust certificate	PTB 01 ATEX 1105
ATEX dust explosion protection	⊕ II 2 D Ex tb IIIC T80 °C Db
Certificate ULus	E182378V1S5
Marking ULus	Class I, Div. 2, Groups A,B,C,D Class II, III, Div. 2, Groups F,G Class I, Zone 1, AEx db eb IIC T6 Enclosure Type 3, 4, 4X
Certificate cUL	E182378V1S5
Marking cUL	Ex db eb IIC T6 Class I, Div. 2, Groups A,B,C,D Class II, III, Div. 2, Groups F,G Enclosure Type 3, 4, 4X
Certificates	ATEX (PTB), Brazil (ULB), Canada (UL), China (NEPSI), IECEX (PTB), India (PESO), Korea (KGS), Taiwan (ITRI), USA (UL)
Ship approval	DNVGL
Notes	Product label for standard configurations as NEC®, CE Code, ATEX, and IECEX. For additional certifications, contact factory.

Control and signalling devices

Control device system Series ConSig 8040

Pushbutton

8040/12E8X-01L12SA05 Art. No. 287018



Electrical Data

Rated operational voltage AC	550 V
Rated operational current	10 A

Ambient Conditions

Ambient temperature	-50 °C ... 40 °C
Ambient temperature	-58 °F ... +104 °F

Mechanical Data

IP degree of protection (IEC 60529)	IP66
Enclosure type (UL50 & UL50E)	3, 4, 4X
Enclosure material	Polyester resin, Glass fibre reinforced
Enclosure colour	Dark grey
Silicone-free	No
Clamping range AWG	14 AWG
Connection cross-section max.	2.5 mm ²
Solid connection cross section	0.32 – 2.5 mm ²
Connection cross-section AWG single stranded	22 AWG ... 14 AWG
Finely stranded connection cross section	0.32 – 2.5 mm ²
Finely stranded connection cross-section AWG	22 AWG ... 14 AWG
Cover fixing type	With captive screws, M4 stainless steel screws
Width	80 mm
Width, inches	3.15 in
Height	139 mm
Height in inches	5.47 in
Depth	72 mm
Depth in inches	2.76 in
Seal	Silicone, foamed
Weight	716 g
Weight	1.58 lb

Mounting / Installation

Tightening torque of cover screw 1	1.4 N · m
Tightening torque of cover screw 1 lbf in	12.4 lbf in

Components

Installation position middle	Pushbutton, Green – "START", With silicone seal
Built-in element middle	Contact element NC/NO
Flange and plates	Metal plate, bottom
Cable glands and entries	NPT 3/4
Entry type	CMP
Entry 1 type	Metal adaptor
Entry 1	NPT 3/4"
Metal entry possible 1	Yes

Control and signalling devices

Control device system Series ConSig 8040

Pushbutton

8040/12E8X-01L12SA05 Art. No. 287018



Technical Drawings – Subject to Alterations

11-○ 12
13-○ 14

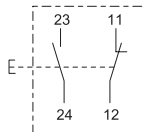

Dimensional Drawings (All Dimensions in mm [inches]) – Subject to Alterations

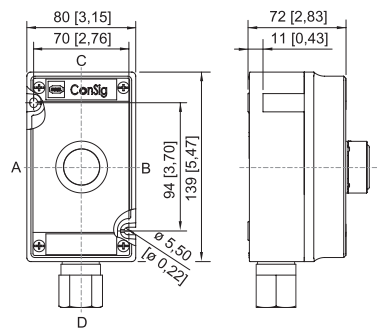

ConSig 8040/12 NEC

Accessories

Pushbutton BG001



Ø 39 mm
 Black
 Designation plate: Black, blank disc without text
 Front panel mounting
 Silicone-free: No

Art. No.

223692

Spare Parts

Designation plates set for BG001, BG023



The button label set contains nine labels
 6x blank disc without text in red, green, white, blue, yellow and black
 1x red label, text: STOP
 1x green label, text: START
 1x blue label, text: RESET

Art. No.

321791

Label holder



Size 1, without insert disc, 1-line label
 for actuators Ø 39

Art. No.

223566



Size 2, without insert disc, 1- or 2-line label
 for actuators Ø 39

Art. No.

223567



Size 3, without insert disc, 1-, 2- or 3-line label
 for actuators Ø 39

Art. No.

223568

Control and signalling devices

Control device system Series ConSig 8040



Pushbutton

8040/12E8X-01L12SA05 Art. No. 287018



Locking devices

Art. No.

	8602C3-753 for not actuated pushbutton BG001	244870
	8602C3-754 for actuated pushbutton BG001	244871
	8602C3-755 for not actuated pushbutton BG001	244872

Special key

Art. No.

	for tightening plastic locking nut	169101
---	------------------------------------	--------

Tag label

Art. No.

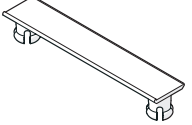
	plain for attaching to enclosure 8040; moulded material; with paper insert strip	130673
--	--	--------

We reserve the right to make alterations to the technical data, dimensions, weights, designs and products available without notice. The illustrations cannot be considered binding.