

6102/111-0110-170-0111-31-4850-00 Art. No. 287786



- Suitable for wall, ceiling and suspended mounting
- With either DALI or address module
- Emergency exit signs with suspended panel so that they can be read from both sides
- Large recognition range  $d \geq 30$  m
- Lightweight, robust and compact design

MY R. STAHL 6102A



The Series C-LUX 6102 compact light fittings can be used for normal lighting or as emergency luminaires in conjunction with emergency exit signs and/or an address module for use in central battery systems.

### Technical Data

#### Explosion Protection

Scope of validity	European Union (ATEX) IECEX
Ex version	Yes
Application range (zones)	1 2 21 22
IECEX gas certificate	IECEX IBE 19.0016
IECEX gas explosion protection	Ex db eb ib op is IIC T4 Gb
IECEX dust certificate	IECEX IBE 19.0016
IECEX dust explosion protection	Ex tb op is IIIC T100 °C Db
ATEX gas certificate	IBExU 19 ATEX 1072
ATEX gas explosion protection	Ex II 2 G Ex db eb ib op is IIC T4 Gb
ATEX dust certificate	IBExU 19 ATEX 1072
ATEX dust explosion protection	Ex II 2 D Ex tb op is IIIC T100 °C Db
Certificates and approvals	ATEX IECEX
Certificates	ATEX (IBE), Brazil (ULB), China (NEPSI), IECEX (IBE), Polen (CNBOP)
Ship approval	DNVGL
Declaration of Conformity	ATEX (EUK), Declaration of Conformity (AUS)

#### Electrical Data

Frequency range	50 – 60 Hz
Operating voltage AC	100 to 240 V $\pm$ 10%
Max operating voltage AC	264 V
Operating voltage DC	100 to 250 V $\pm$ 10%
Max. operating voltage DC	275 V
Control interface	DALI

6102/111-0110-170-0111-31-4850-00 Art. No. 287786

**Lighting Data**

Lamp	LED
Light colour	Cool white
Light distribution	80° (with diffuser)
Luminaire efficacy	62 lm/W
Luminous flux	600 lm
Luminous flux	600 lm
Colour rendering	≥ 80
Colour temperature	5000 K
Colour temperature	5000 K

**Ambient Conditions**

Ambient temperature	-40 °C ... +50 °C Note: Through wiring Max. 3x16 A -40 °C ... +60 °C Note: Through wiring 2 Max. 3x10 A
---------------------	--

**Mechanical Data**

IP degree of protection (IEC 60598)	IP66 / IP67
Class	I
Enclosure material	Thermoset
Enclosure colour	Light grey (RAL 7035)
Diffuser	With diffuser 2 x 40°
Cover material	Polycarbonate
Sealing material	Silicone
Silicone-free content	Without influence on paint wetting
Installed terminal strip	PE + N + L1 + L2 + L3 + D1+D2
Max. solid connection terminals	6 mm <sup>2</sup>
Max. finely stranded connection terminals	4 mm <sup>2</sup>
Type of connection cable	Finely stranded Solid
Size	1
Width	185 mm
Height	90 mm
Length	440 mm
Impact strength (IEC 62262)	IK08
Weight	3 kg
Weight	6.61 lb
Disconnection of the luminaire	No

**Components**

Version	With diffuser 2 x 40°
Threaded plate	Plastic
Ballast	6045/311-841-20 AC/DC DALI
Through wiring	Loop in/loop out
Drilled holes	3 x M25
Cable glands and entries	2 x M25 Ø 7 ...
Stopping plugs	2 x M25 x 1.5
Stopping plug material	Polyamide, black
Breather	without
Accessories	Provided

6102/111-0110-170-0111-31-4850-00 Art. No. 287786

### Light Distribution Curves

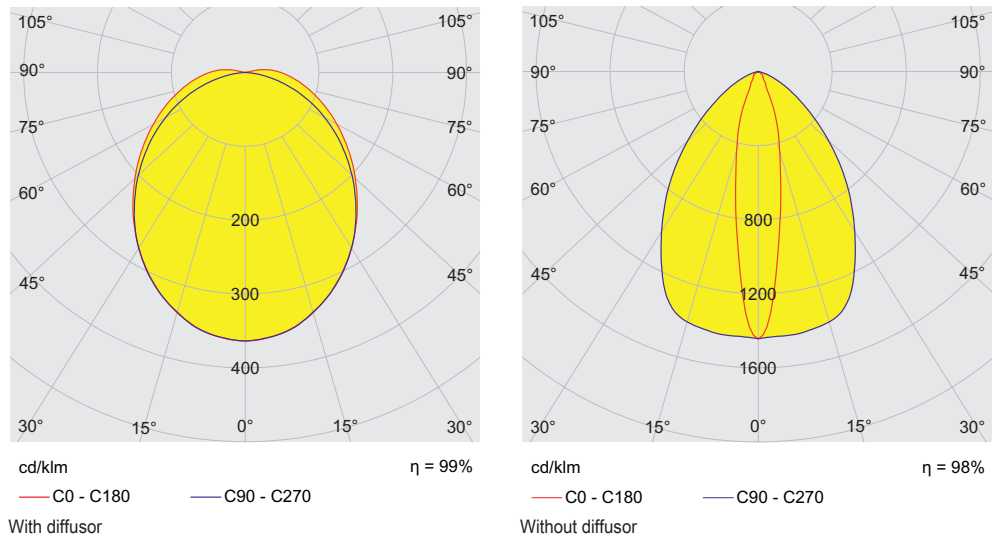

### Dimensional Drawings (All Dimensions in mm [inches]) – Subject to Alterations

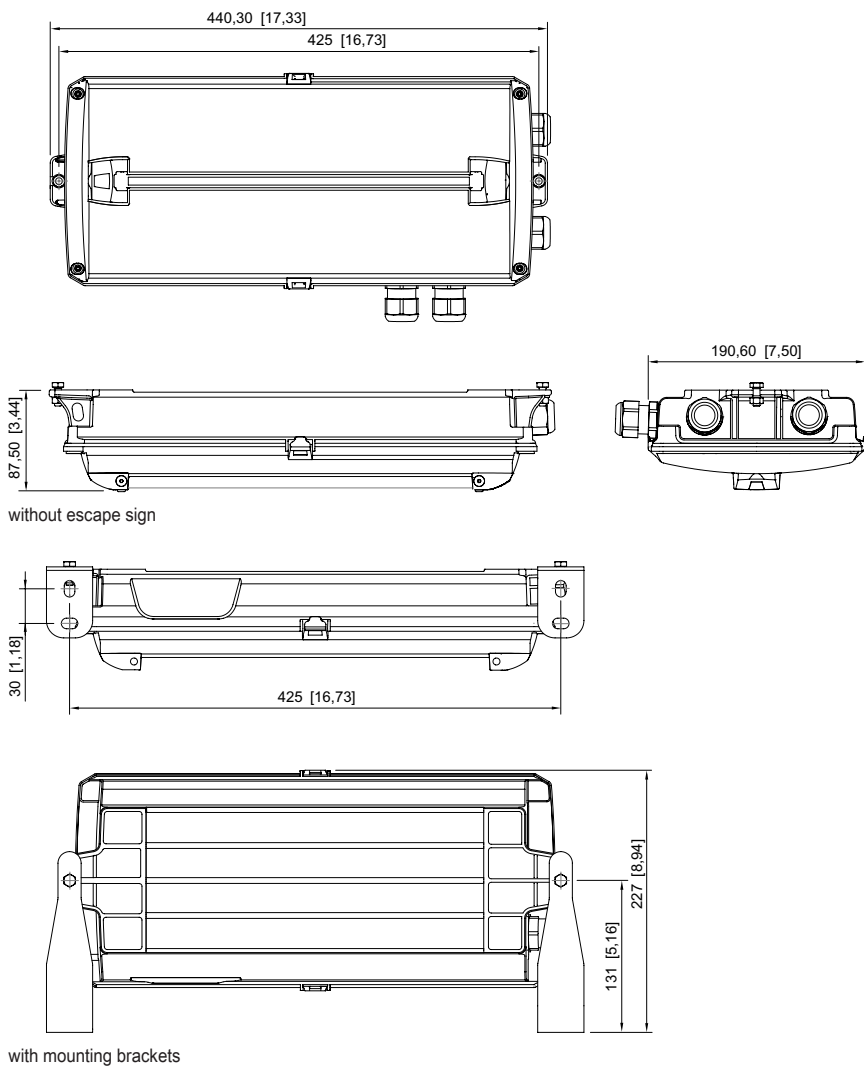

# Lighting

## Compact light fitting Emergency luminaire





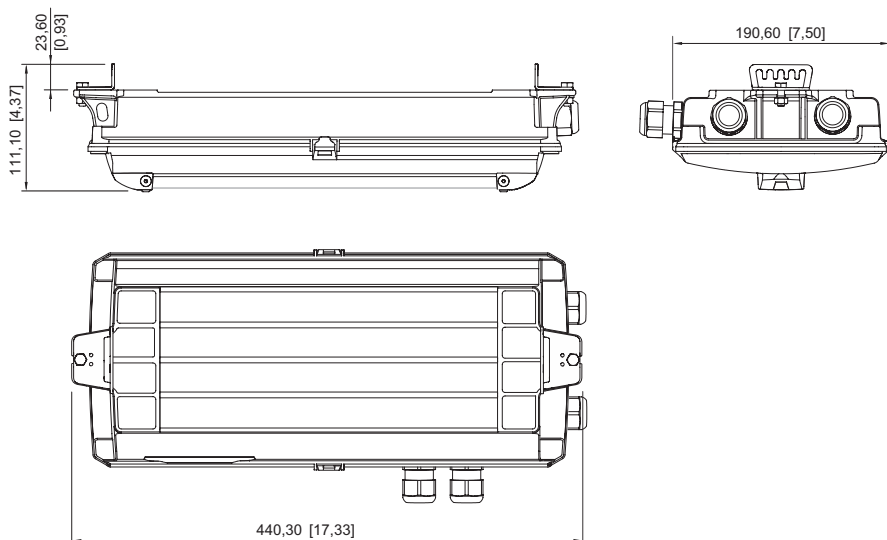



6102/111-0110-170-0111-31-4850-00 Art. No. 287786

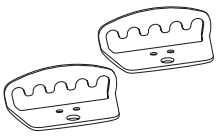
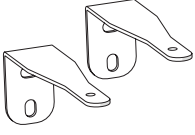

for rope/chain mounting

### Accessories









Fastening set		Art. No.
	for chain/rope assembly	275407
	for wall mounting	275408
Light panel		Art. No.
	Escape route double sided	275872
	Escape route, down	274776
	Escape route, up	274758
	Escape route, down double-sided	274780
	Escape route, left	274757

# Lighting



## Compact light fitting Emergency luminaire



6102/111-0110-170-0111-31-4850-00 Art. No. 287786

	Escape route, right	274775
	Escape route left/right double-sided	274773
	Escape route stairs, down left	274777
	Escape route stairs, down right	274778
	Escape route stairs, down double-sided	274779
	Escape route stairs, up left	274759
	Escape route stairs, up right	274760
	Escape route stairs, up double-sided	274771
	Escape route, up double-sided	274772
	EXIT	275514

### Spare Parts

Optic		Art. No.
	Diffuser	274756
	Deflection optics	274781

We reserve the right to make alterations to the technical data, dimensions, weights, designs and products available without notice. The illustrations cannot be considered binding.