

# Lighting

## Linear luminaire With LED

GRP

6002/4164-0200-152-1110-11-850S Art. No. 288600



- The latest LED technology with a high luminous efficacy and a long service life
- Extremely high luminaire efficacy
- Luminous flux after 100,000 h still 90% of the starting luminous flux
- Optionally with DALI for controlling and monitoring the luminaire
- Optionally addressable for direct actuation of a common battery system

MY R. STAHL 6002D



The linear luminaire with Series 6002/4 LED is ideal for lighting surfaces at a mounting height of up to 10 m. It can also be used to illuminate equipment and objects, both inside and outside. The pole mounting sleeve accessory can be used to easily mount the luminaire on poles. Optionally, the luminaire can be equipped with addressable equipment. It can be used to control and monitor the luminaire for the common battery systems.

### Technical Data

#### Explosion Protection

Ex version	Yes
Application range (zones)	1, 2, 21, 22
IECEX gas certificate	IECEX IBE 14.0035
IECEX gas certificate	IECEX IBE 14.0035
IECEX gas explosion protection	Ex db eb ib op is IIC T4 Gb
IECEX dust certificate	IECEX IBE 14.0035
IECEX dust explosion protection	Ex tb op is IIIC T100 °C Db
ATEX gas certificate	IBExU 14ATEX1088
ATEX gas certificate	IBExU 14ATEX1088
ATEX gas explosion protection	⊕ II 2 G Ex db eb ib op is IIC T4 Gb
ATEX dust certificate	IBExU 14ATEX1088
ATEX dust explosion protection	⊕ II 2 D Ex tb op is IIIC T100 °C Db
Certificates and approvals	ATEX IECEX UKEX
Certificates	ATEX (IBE), IECEX (IBE), India (PESO)
Ship approval	DNV
Declaration of conformity	ATEX (EUK)

#### Electrical Data

Rated operational voltage AC	110 ... 240 V
Rated operational voltage DC	110 ... 250 V
Frequency range	50 – 60Hz

#### Lighting Data

Number of lamps	1
Lamp wattage	50 W
Lamp	LED

#### Lighting Data

Light colour	5000 K – neutral white
Light distribution	120°x120°
Luminaire efficacy	120 lm/W
Luminous flux	6000 lm
Colour rendering	≥ 80
Colour temperature	5000 K

#### Ambient Conditions

Ambient temperature	-20 °C ... 50 °C Note: Through wiring Max. 3x16 A -20 °C ... 60 °C Note: Through wiring 2 Max. 3x10 A
---------------------	--

#### Mechanical Data

Version	Standard
Translucent cover	Translucent
IP degree of protection (IEC 60598)	IP66
Enclosure material	Polyester resin, Glass fibre reinforced
Enclosure colour	Light grey (RAL 7035)
Diffuser	Without diffuser
Sealing material	Silicone
Silicone-free content	Contains silicone
Translucent cover material	Polycarbonate
Installed terminal strip	PE + N + L1 + L2 + L3
Max. solid connection terminals	6 mm <sup>2</sup>
Max. finely stranded connection terminals	4 mm <sup>2</sup>
Type of connection cable	Finely stranded Solid
Size	6
Width	184 mm
Height	125 mm
Length	1610 mm
Impact strength (IEC 62262)	IK10
Weight	8 kg
Weight	17.64 lb
Disconnection of the luminaire	No

#### Components

Threaded plate	2x plastic
Ballast	6045/311-110-10
Through wiring	With 5 conductors 2.5 mm <sup>2</sup>
Drilled holes	3 x M25
Cable glands and entries	2 x M25 Ø 7 ... 17 mm
Material cable gland	Polyamide, black
Stopping plugs	2 x M25 x 1.5
Stopping plug material	Polyamide, black
Accessories	Provided

# Lighting

## Linear luminaire With LED

### GRP

6002/4164-0200-152-1110-11-850S Art. No. 288600



#### Dimensional Drawings (All Dimensions in mm [inches]) – Subject to Alterations

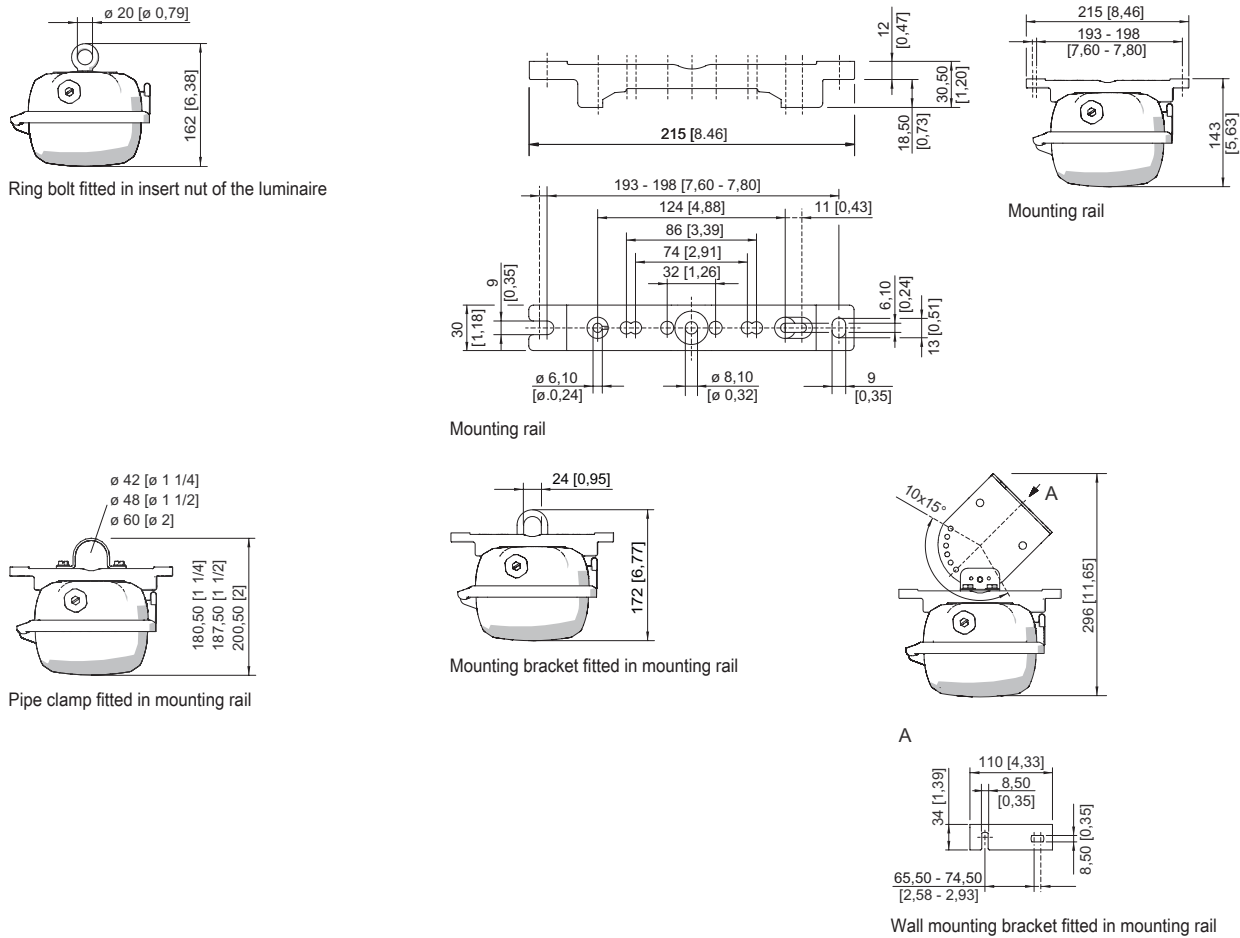

## Accessories

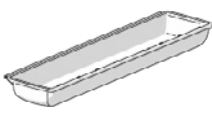
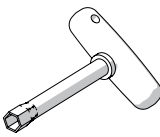
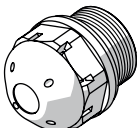
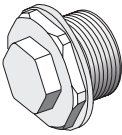
		Art. No.
		288538
	M8 / A/F 13; For actuating the central lock	222430
	Thread: M25 x 1.5 (20 pieces); without jam nut	285780
	Thread: M25 x 1.5 (1 piece); for installation in light fittings; made from stainless steel; without jam nut	296608



# Lighting

## Linear luminaire With LED

GRP

6002/4164-0200-152-1110-11-850S Art. No. 288600

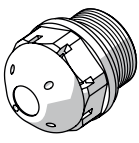
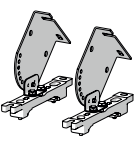
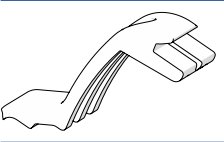
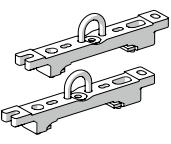
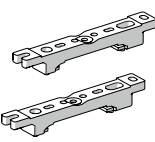
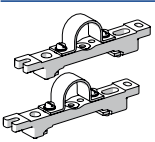
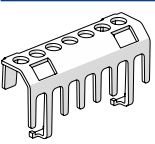

	M25 x 1.5 in order to avoid condensate formation	115738
<b>Ceiling and wall mounting bracket</b>		<b>Art. No.</b>
	mounted on a mounting rail for a variable mounting distance; Material: stainless steel; Lamp can be swiveled in steps of 15°; 1 pair	222827
<b>Holder for translucent cover</b>		<b>Art. No.</b>
	The fall prevention system for the light fitting cover prevents the light fitting cover from falling accidentally when the light fitting is opened.	226791
<b>Mounting bracket</b>		<b>Art. No.</b>
	mounting clamp mounted on a mounting rail for a variable mounting distance; 1 pair	222456
<b>Mounting rail</b>		<b>Art. No.</b>
	for a variable mounting distance; 1 pair	222826
<b>Pipe clamp</b>		<b>Art. No.</b>
	R 1 1/2"; with mounting rail for a variable mounting distance; material: stainless steel; 1 pair	222459
	R 1 1/4"; with mounting rail for a variable mounting distance; Material: stainless steel; 1 pair	222458
	R 2"; with mounting rail for a variable mounting distance; Material: stainless steel; 1 pair	222460
<b>Protection against accidental contact</b>		<b>Art. No.</b>
	The protection against accidental contact prevents maintenance technicians and electrical installers from accidentally touching conductive parts. The degree of protection is increased to IP20 when the protection against accidental contact is used.	283153
<b>Ring bolt</b>		<b>Art. No.</b>
	M8, direct mounting in insert nuts; 1 pair	115736

We reserve the right to make alterations to the technical data, dimensions, weights, designs and products available without notice. The illustrations cannot be considered binding.