

Control and signalling devices

Control device system ConSig 8040 series



ConSig

8040/1280X-54C06SXXX-23D01SA05 Art. No. 130898



- Flexible: Modular design and three sizes make customer-specific versions possible
- Lightweight enclosure made of glass fibre reinforced polyester resin (GRP), suitable for the marine industry and offshore applications

MY R. STAHL 8040B



With the R. STAHL Series 8040 control device system, you can get a clear overview of the control devices. The three combinable sizes and the modular design offer flexibility. You can choose from one standard version and customised variants.

Technical Data

Explosion Protection

Scope of validity	IECEX European Union (ATEX)
Application range (zones)	1 2 21 22
IECEX gas certificate	IECEX PTB 06.0025
IECEX gas explosion protection	Ex db eb IIC T6 / T5 Gb
IECEX dust certificate	IECEX PTB 06.0025
IECEX dust explosion protection	Ex tb IIIC T80 °C / T95 °C Db
ATEX gas certificate	PTB 01 ATEX 1105
ATEX gas explosion protection	⊕ II 2 G Ex db eb IIC T6 / T5 Gb
ATEX dust certificate	PTB 01 ATEX 1105
ATEX dust explosion protection	⊕ II 2 D Ex tb IIIC T80 °C / T95 °C Db
Certificates	ATEX (PTB), Brazil (ULB), Canada (UL), China (NEPSI), IECEX (PTB), India (PESO), Korea (KGS), Taiwan (ITRI), USA (UL)
Ship approval	DNVGL
Declaration of Conformity	ATEX (EUK), China (CCC)
Explosion protection note	Product label may vary. Series devices are labelled with ATEX and IECEX.

Electrical Data

Rated operational voltage AC	690 V
Rated operational current	10 A (T6)

Ambient Conditions

Ambient temperature	-60 °C ... +40 °C (T6) -60 °C ... +55 °C (T5)
Ambient temperature	-76 °F ... +104 °F (T6) -76 °F ... +131 °F (T5)

Mechanical Data

Degree of protection (IP)	IP66
---------------------------	------

Control and signalling devices

Control device system ConSig 8040 series



8040/1280X-54C06SXXX-23D01SA05 Art. No. 130898

Mechanical Data

Degree of protection IP (IEC 60529)	IP66
Enclosure material	Polyester resin, Glass fibre reinforced
Enclosure colour	Dark grey
Silicone-free	No
AWG clamping range	14 AWG
Connection cross-section max.	2.5 mm ²
Solid connection cross section	0.32 – 2.5 mm ²
Connection cross-section AWG single stranded	22 AWG to 14 AWG
Finely stranded connection cross section	0.32 – 2.5 mm ²
Finely stranded connection cross-section AWG	22 AWG - 14 AWG
Cover fixing type	With captive screws, M4 stainless steel screws
Width	80 mm
Width, inches	3.15 in
Height	139 mm
Height, inches	5.47 in
Depth	72 mm
Depth, inches	2.76 in
Seal	Silicone, foamed
Weight	540 g
Weight	1.19 lb

Mounting / Installation

Tightening torque of cover screw 1	1.4 Nm
Tightening torque of cover screw 1 lbf in	12.4 lbf in

Components

Installation position top	Indicator lamp bezel, All colours
Built-in element top	LED indicator lamp
Installation position bottom	Twin pushbutton, Red "0", green "I"
Built-in element bottom	Contact element NC/NO
Flange and plates	Without flange, without plates
Entry type	Standard 8161, moulded material
Entry 1	1 x 8161/7-M25-1707-LT
Entry 1 type	Polyamide cable gland, black
Entry 1	M25 x 1.5
Entry 1 terminal area	7 – 17 mm
Entry 1 clamping range, inch	0.28 – 0.67 in
Metal entry possible 1	No

8040/1280X-54C06SXXX-23D01SA05 Art. No. 130898

Technical Drawings – Subject to Alterations

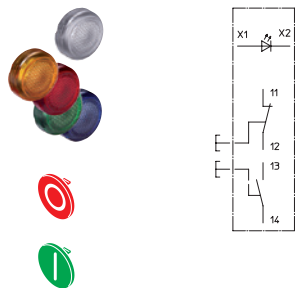

Dimensional Drawings (All Dimensions in mm [inches]) – Subject to Alterations

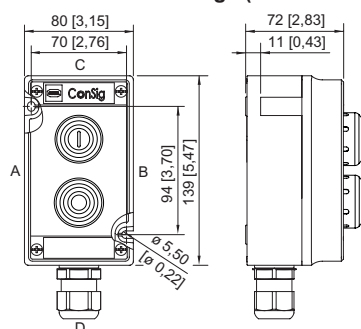

ConSig 8040/12

Accessories

Indicator lamp bezel

		Art. No.
BG054		
	Diameter 39 mm All colours Silicone-free: No	223123

Twin pushbutton

		Art. No.
BG023		
	Black Silicone-free: No	244639

Spare Parts

Caps for BG054

		Art. No.
	for indicator lamp, all colours packaged	248685

Label holder



		Art. No.
	Size 1, without insert disc, 1-line label for actuators Ø 39	223566

Control and signalling devices

Control device system ConSig 8040 series



8040/1280X-54C06SXXX-23D01SA05 Art. No. 130898

	Size 2, without insert disc, 1- or 2-line label for actuators Ø 39	223567
	Size 3, without insert disc, 1-, 2- or 3-line label for actuators Ø 39	223568
Special key		Art. No.
	for tightening plastic locking nut	169101

We reserve the right to make alterations to the technical data, dimensions, weights, designs and products available without notice. The illustrations cannot be considered binding.