

8040/1280X-54C06SXXX-23D01SA05 Art. No. 130898



- Flexible: Modular design and three sizes make customer-specific versions possible
- Lightweight enclosure made of glass fibre reinforced polyester resin (GRP), suitable for the marine industry and offshore applications

### MY R. STAHL 8040B



With the R. STAHL Series 8040 control device system, you can get a clear overview of the control devices. The three combinable sizes and the modular design offer flexibility. You can choose from one standard version and customised variants.

## Technical Data

### Explosion Protection

Area of application	IECEX European Union (ATEX)
Application range (zones)	1, 2, 21, 22
IECEX gas certificate	IECEX PTB 06.0025
IECEX gas certificate	IECEX PTB 06.0025
IECEX gas explosion protection	Ex db eb IIC T6 / T5 Gb
IECEX dust certificate	IECEX PTB 06.0025
IECEX dust explosion protection	Ex tb IIIC T80 °C / T95 °C Db
ATEX gas certificate	PTB 01 ATEX 1105
ATEX gas certificate	PTB 01 ATEX 1105
ATEX gas explosion protection	⊕ II 2 G Ex db eb IIC T6 / T5 Gb
ATEX dust certificate	PTB 01 ATEX 1105
ATEX dust explosion protection	⊕ II 2 D Ex tb IIIC T80 °C / T95 °C Db
Certificates	ATEX (PTB), Brazil (ULB), Canada (UL), China (NEPSI), IECEX (PTB), India (PESO), Korea (KGS), Taiwan (ITRI), USA (UL)
Ship approval	DNVGL
Declaration of conformity	ATEX (EUK), China (CCC)
Explosion protection note	Product label may vary. Series devices are labelled with ATEX and IECEX.

### Electrical Data

Rated operational voltage AC	690 V
Rated operational current	10 A (T6)

### Ambient Conditions

Ambient temperature	-60 °C ... 40 °C (T6) -60 °C ... 55 °C (T5)
Ambient temperature	-76 °F ... 104 (T6) -76 °F ... +131 °F (T5)

### Mechanical Data

IP degree of protection (IEC 60529)	IP66
-------------------------------------	------

# Control and signalling devices

## Control device system Series ConSig 8040



8040/1280X-54C06SXXX-23D01SA05 Art. No. 130898

### Mechanical Data

Enclosure material	Polyester resin, Glass fibre reinforced
Enclosure colour	Dark grey
Silicone-free	No
Connection cross-section max.	2.5 mm <sup>2</sup>
Solid connection cross section	0.32 – 2.5 mm <sup>2</sup>
Connection cross-section AWG single stranded	22 AWG ... 14 AWG
Finely stranded connection cross section	0.32 – 2.5 mm <sup>2</sup>
Finely stranded connection cross-section AWG	22 AWG ... 14 AWG
Cover fixing type	With captive screws, M4 stainless steel screws
Width	80 mm
Width, inches	3.15 in
Height	139 mm
Height in inches	5.47 in
Depth	72 mm
Depth in inches	2.76 in
Seal	Silicone, foamed
Weight	540 g
Weight	1.19 lb

### Mounting / Installation

Tightening torque of cover screw 1	1.4 N · m
Tightening torque of cover screw 1 lbf in	12.4 lbf in

### Components

Installation position top	Indicator lamp bezel, All colours
Built-in element top	LED indicator lamp
Installation position bottom	Twin pushbutton, Red "0", green "I"
Built-in element bottom	Contact element NC/NO
Flange and plates	Without flange, without plates
Cable glands and entries	1 x M25 Ø 7 ... 17 mm
Entry type	Standard 8161, moulded material
Entry 1	1 x 8161/7-M25-1707-LT
Entry 1 type	Polyamide cable gland, black
Entry 1	M25 x 1.5
Entry 1 clamping range	7 – 17 mm
Entry 1 clamping range, inch	0.28 – 0.67 in
Metal entry possible 1	No

8040/1280X-54C06SXXX-23D01SA05 Art. No. 130898

**Technical Drawings – Subject to Alterations**

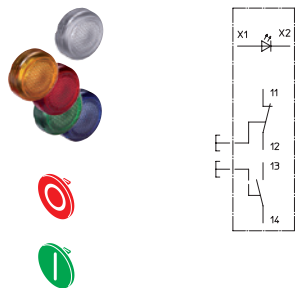

**Dimensional Drawings (All Dimensions in mm [inches]) – Subject to Alterations**

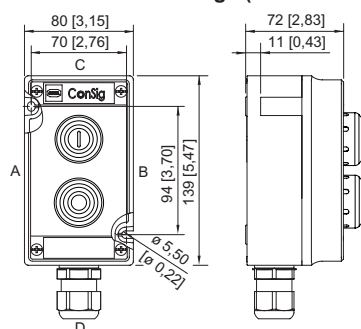

ConSig 8040/12

**Accessories**

**Indicator lamp bezel  
BG054**



Diameter 39 mm  
All colours  
Silicone-free: No

**Art. No.**

223123

**Twin pushbutton  
BG023**



Black  
Front panel mounting  
Silicone-free: No

**Art. No.**

244639

**Spare Parts**

**Caps for BG054**



for indicator lamp, all colours packaged

**Art. No.**

248685

8040/1280X-54C06SXXX-23D01SA05 Art. No. 130898



**Designation plates set for BG001, BG023**

**Art. No.**

	<p>The button label set contains nine labels 6x blank disc without text in red, green, white, blue, yellow and black 1x red label, text: STOP 1x green label, text: START 1x blue label, text: RESET</p>	<p>321791</p>
--	--	---------------

**Label holder**

**Art. No.**

	<p>Size 1, without insert disc, 1-line label for actuators Ø 39</p>	<p>223566</p>
	<p>Size 2, without insert disc, 1- or 2-line label for actuators Ø 39</p>	<p>223567</p>
	<p>Size 3, without insert disc, 1-, 2- or 3-line label for actuators Ø 39</p>	<p>223568</p>

**Special key**

**Art. No.**

	<p>for tightening plastic locking nut</p>	<p>169101</p>
--	---	---------------

**Tag label**

**Art. No.**

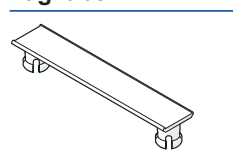
	<p>plain for attaching to enclosure 8040; moulded material; with paper insert strip</p>	<p>130673</p>
--	---	---------------

We reserve the right to make alterations to the technical data, dimensions, weights, designs and products available without notice. The illustrations cannot be considered binding.