

8265/66-0020 Art. No. 202082

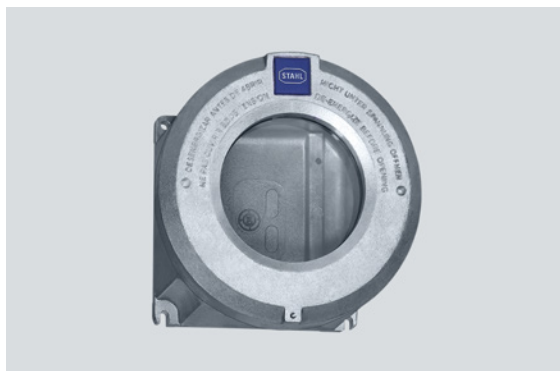

- Six basic enclosure sizes, optional sight glasses
- International certification, wide temperature range, seawater-resistant enclosure made of light metal
- Empty enclosure
- Customer-specific entries available on request
- For use in Class I, Div. 1 and 2

MY R. STAHL 8265K



R. STAHL Series 8265 Ex d enclosures are explosion-protected and dust-explosion-protected empty enclosures with global approval. The cover can be opened wide to allow easier access for installing and servicing components inside the enclosure. The cover is also available with a sight glass. R. STAHL can install various different devices in the enclosure, including components which generate arcs and sparks, depending on customer requirements. Ask your R. STAHL representative whether the equipment you require can be installed in the enclosure.

Technical Data

Explosion Protection	
Application range (zones)	1, 2, 21, 22
IECEX gas certificate	IECEX PTB 07.0027 U
IECEX gas explosion protection	Ex db eb IIC Gb
IECEX dust certificate	IECEX PTB 07.0027 U
IECEX dust explosion protection	Ex tb IIIC Db
ATEX gas certificate	PTB 06 ATEX 1023 U
ATEX gas explosion protection	Ex II 2 G Ex db eb IIC Gb
ATEX dust certificate	PTB 06 ATEX 1023 U
ATEX dust explosion protection	Ex II 2 D Ex tb IIIC Db
Certificate ULus	E307783
Marking ULus	Class I, Div. 1, Groups A,B,C,D Class II,III, Div. 1, E, F, G Class I, Zone 1, Group IIC Enclosure Type 3, 4, 4X
Certificate cUL	E307783
Marking cUL	Class I, Zone 1, Group IIC Class I, Div. 1, Groups A,B,C,D Class II,III, Div. 1, E, F, G Enclosure Type 3, 4, 4X
Marking Notes	also for installation in Class I, II and III, Div. 2
Certificates	ATEX (PTB), Canada / USA (UL), Canada (UL), IECEX (PTB), USA (UL)
Ambient Conditions	
Ambient temperature	-25 °C ... +50 °C
Ambient temperature	-13°F ... +122°F
Mechanical Data	
Degree of protection (IP)	IP54

8265/66-0020 Art. No. 202082

Mechanical Data

Degree of protection note	IP66 with silicone O-ring
Enclosure type (NEMA250)	3, 4, 4X
Enclosure material	Aluminium, copper-free, Seawater-resistant
Enclosure colour	without
Clamping range max.	120 mm ²
Cover	With inspection window
Design	Without entry
Width	335 mm
Width, inches	13.19 in
Height	281 mm
Height in inches	11.06 in
Length	335 mm
Length in inches	13.19 in
Diameter	410 mm
Diameter inch	16.14 in
Enclosure size	6
Weight	28 kg
Weight	61.62 lb

Dimensional Drawings (All Dimensions in mm [inches]) – Subject to Alterations

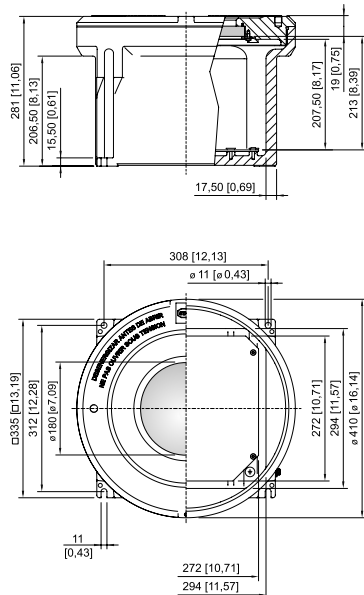

Size 6 enclosure with sight glass

Accessories

Cover with sight glass

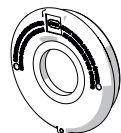

Enclosure: 8265/66-0020
Visible cut-out in the sight glass dia. 188 mm [7.4 inch]

Art. No.

201890

8265/66-0020 Art. No. 202082

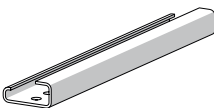
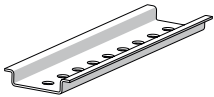
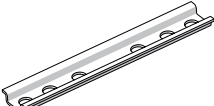
Mounting rail		Art. No.
	G32 length: 280 mm [11.02 inch] for size 6 enclosure	166450
	TS35 length: 280 mm [11.02 inch] for size 6 enclosure	166449
	TS15 length: 280 mm [11.02 inch] for size 6 enclosure	166448

Mounting plate		Art. No.
	for size 6 enclosure M5 x 8 screws are included in the delivery	316182

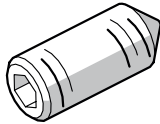
Threaded pin		Art. No.
	M5x16-A2 with hexagon socket and pointed tip	110216

Spare Parts

O-ring		Art. No.
	Silicone, for size 6 enclosure	305633

We reserve the right to make alterations to the technical data, dimensions, weights, designs and products available without notice. The illustrations cannot be considered binding.