

Lighting

LED portable lamp Complete set



6148/1111-111 Art. No. 209686



- Energy-saving, bright LED technology
- Approved in accordance with the relevant firefighting standard
- Lamp head pivots 190°
- Incredibly lightweight
- Main light continuously dimmable
- Long battery life
- Ergonomic one-hand operation

MY R. STAHL 6148A



The ergonomic design of the 6148 series portable LED lamp allows you to operate this lamp with just one hand. Its brightness can be freely adjusted; alternatively, it can be set to flashing mode. The pivoting lamp head allows you to direct the light cone virtually anywhere. Coloured diffusing lenses are available as accessories, and transform your lamp into a portable Ex beacon. It approved for use in vehicles, and when connected to the charging unit, has an emergency lighting function.

Technical Data

Explosion Protection	
Ex version	Yes
Application range (zones)	1, 2, 21, 22
IECEX gas certificate	IECEX IBE 11.0009
IECEX gas explosion protection	Ex ib IIC T4 Gb
IECEX dust certificate	IECEX IBE 11.0009
IECEX dust explosion protection	Ex tb IIIC T75 °C Db
ATEX gas certificate	IBExU 11ATEX 1066
ATEX gas explosion protection	⊕ II 2 G Ex ib IIC T4 Gb
ATEX dust certificate	IBExU 11ATEX 1066
ATEX dust explosion protection	⊕ II 2 D Ex tb IIIC T75 °C Db
Approval for motor vehicles	E1 10 R - 036569
Certificates	ATEX (IBE), IECEX (IBE)
Declaration of Conformity	ATEX (EUK)
Electrical Data	
Rated operational voltage DC	12 ... 30 V
Battery version	Lead-fleece battery
Lighting Data	
Number of lamps	2
Lamp	LED
Light colour	6500 K
Light intensity	40000 cd
Light distribution	In accordance with DIN 14642
Ambient Conditions	
Ambient temperature	-20 °C ... +50 °C
Storage temperature	-25 °C ... +60 °C

Lighting

LED portable lamp Complete set



6148/1111-111 Art. No. 209686

Mechanical Data

Degree of protection (IP)	IP66
Class	II (double insulated)
Enclosure material	Polyamide, Impact resistant
Enclosure colour	Black
Silicone-free content	Contains silicone
Type of connection cable	Charging cable 110 to 240 V AC
Cable length	1.8 m
Width	92 mm
Height	143 mm
Length	279 mm
Headlamp head tilting function	Front: 100°, rear: 90°
Weight	1.83 kg
Weight	4.03 lb

Components

Plug	Euro plug, 2-pole
Battery-Version	Lead-fleece battery, Maintenance-free, 6 V, 4.5 Ah

Dimensional Drawings (All Dimensions in mm [inches]) – Subject to Alterations

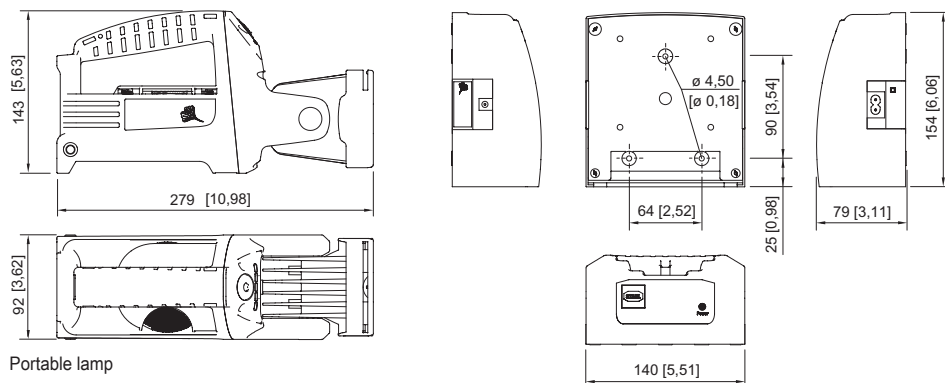

Portable lamp

Charging unit

Accessories

Adaptor for external charging unit.

	for charging the portable lamp in the KFZ90 or LG443 charging unit	Art. No. 212701
--	--	---------------------------

Belt hook

	for fastening the portable lamp to the belt	Art. No. 212331
--	---	---------------------------

Lighting





LED portable lamp Complete set



6148/1111-111 Art. No. 209686

Diffusing lens

Art. No.

	clear	212333
	green	220306
	orange	212334
	red	212956

Shoulder strap

Art. No.

	for carrying the portable lamp	212702
--	--------------------------------	--------

Wall bracket

Art. No.

	for wall mounting the charging unit	212332
--	-------------------------------------	--------

Spare Parts

Battery

Art. No.

	for 6148 lead-fleece battery, 6 V, 4.5 Ah	211124
--	---	--------

Charging unit

Art. No.

	for 6148 (12 – 30 V DC and 100 – 240 V AC)	209688
--	--	--------

Connection cable

Art. No.

	230 V charging cable with plug	120014
--	--------------------------------	--------

Lighting

LED portable lamp Complete set



6148/1111-111 Art. No. 209686



12/24 V charging cable with plug

212316

We reserve the right to make alterations to the technical data, dimensions, weights, designs and products available without notice. The illustrations cannot be considered binding.