

Installation equipment

Mushroom stay-put button With key



8602C3-006-B .. MS1 Art. No. 223695



- Pushbutton, mushroom pushbutton, mushroom stay-put button with key lock, mushroom stay-put button, twin pushbutton and illuminated pushbutton, rotary actuator, key-operated switch, potentiometer bezel and indicator lamp bezel
- One axial actuator can actuate up to four Series 8082 contact elements
- Key-operated switches and rotary switches codable at any time as "latching/spring return" or "key not removable"

MY R. STAHL 8602A



Thanks to their special technical features, the actuators from the 8602/3 series can withstand the most extreme conditions. In addition to the application option for use in ambient temperatures from -60 °C to +70 °C, the IP degree of protection, IP66, is maintained in accordance with EN 60529. It is also possible to actuate up to four contact elements from the 8082 series with a single axial actuator from the 8602/3 series.

The coding option of the key switches and rotary switches is innovative and one-of-a-kind. Integrated coding allows you to adjust the "latching/spring return" and/or "key not removable" functions at any time without additional accessories. A versatile set of accessories consisting of label holders and locking devices is available.

Technical Data

Explosion Protection

Application range (zones)	1 2 21 22
IECEX gas certificate	IECEX PTB 13.0047U
IECEX gas explosion protection	Ex eb IIC Gb
IECEX dust certificate	IECEX PTB 13.0047 U
IECEX dust explosion protection	Ex tb IIIC Db
ATEX gas certificate	PTB 13 ATEX 1019 U
ATEX gas explosion protection	Ex II 2 G Ex eb IIC Gb
ATEX dust certificate	PTB 13 ATEX 1019 U
ATEX dust explosion protection	Ex II 2 D Ex tb IIIC Db
UL gas certificate	E182378 V4 S2
Inmetro gas certificate	UL-BR 14.0380U
Inmetro dust certificate	UL-BR 14.0380U
Certificates	ATEX (PTB), Brazil (ULB), Canada / USA (UL), Canada (UL), IECEX (PTB), India (PESO), Korea (KGS)

Functional Safety

SIL-capable	Only with contact elements 8082/1, 8082/2 and 8208/24-15
-------------	--

Ambient Conditions

Ambient temperature	-20 °C ... +60 °C
Ambient temperature	-4 °F ... +140 °F
Storage temperature	-25 °C ... +60 °C

Installation equipment

Mushroom stay-put button With key

8602C3-006-B .. MS1 Art. No. 223695

Ambient Conditions

Storage temperature	-13 °F ... +140 °F
Use at the height of	< 2000 m
Degree of contamination	3

Mechanical Data

Version	with key lock
Degree of protection (IP)	IP66
Note on degree of protection	According to IEC/EN 60529
Enclosure material	Polyamide
Silicone-free	Yes
Assembly	006
Diameter	39 mm
Service life, min.	10 ⁵ actuations
Impact strength (IEC 60079)	7 J
Impact strength (IEC 62262)	min. IK08
Colour	Red/black
Fastening	Thread type
Seal	Standard
Closing	MS1
Packaging unit	1
Weight	75 g
Weight	0.17 lb
Description note	Two keys enclosed.

Mounting / Installation

Tightening torque	3 Nm
Tightening torque lbf in	26.55 lbf in

Technical Drawings – Subject to Alterations

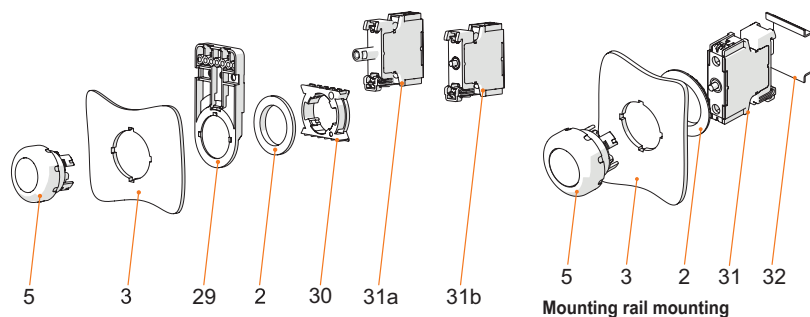

Front installation mounting with Series 8010/6 indicator lamp and Series 8082/3 contact element

Mounting rail mounting

Key

- 2 = jam nut (order no. 205592)
- 3 = installation wall (wall thickness max. 5 mm [0.197 inch])
- 5 = actuator with seal
- 29 = support for cable duct (optional) (order no. 248673)
- 30 = adaptor (order no. 227038)
- 31a = built-in element: LED element 8010/6
- 31b = built-in element: Contact element 8082/3

Key

- 2 = jam nut (order no. 205592)
- 3 = installation wall (wall thickness max. 5 mm [0.197 inch])
- 5 = actuator with seal
- 31 = built-in element
- 32 = TS35 mounting rail

Installation equipment

Mushroom stay-put button With key



8602C3-006-B .. MS1 Art. No. 223695

Dimensional Drawings (All Dimensions in mm [inches]) – Subject to Alterations

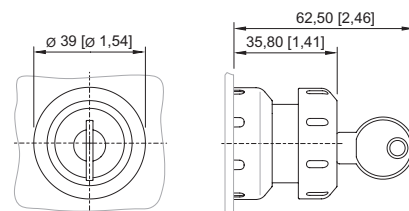
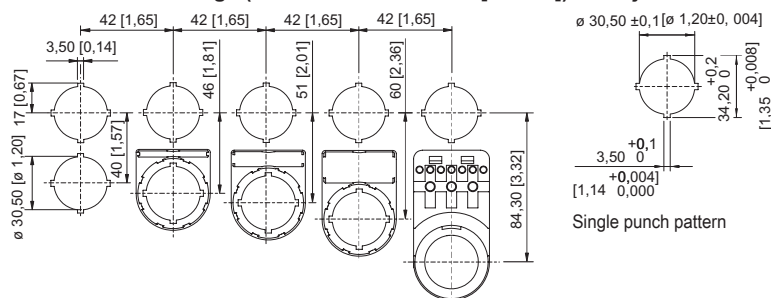

8602/3-006 red/black mushroom stay-put button with key lock
 8602/3-009 red/yellow mushroom stay-put button with key lock
 Actuator with axial actuation

Cut-out with/without additional designation plate

Accessories

Spare key





Closing MS1

Art. No.

107109

Spare Parts

Insert discs for label holder

		Art. No.
	One-line Plain Material: PVC Colour: White Self-adhesive	238271
	Two-line Plain Material: PVC Colour: White Self-adhesive	238272
	Three-line Plain Material: PVC Colour: White Self-adhesive	238273

Closing part



8602C3-733-B
for closing unused holes in cover, dia. 30.5 mm, NBR

8602C3-733-S
for closing unused holes in cover, dia. 30.5 mm, silicone

Art. No.

244306

244307

Protective collar



8602C3-751 plastic/red for mushroom stay-put button with key lock/mushroom stay-put button
 dia. 39
 BG006, BG009, BG010, BG012

Art. No.









257707

Installation equipment

Mushroom stay-put button With key



8602C3-006-B .. MS1 Art. No. 223695

	8602C3-751 plastic/yellow for mushroom stay-put button with key lock/mushroom stay-put button dia. 39 BG006, BG009, BG010, BG012	257708
Label holder		Art. No.
	Size 1, without insert disc, 1-line label for actuators Ø 39	223566
	Size 2, without insert disc, 1- or 2-line label for actuators Ø 39	223567
	Size 3, without insert disc, 1-, 2- or 3-line label for actuators Ø 39	223568
Special key		Art. No.
	for tightening plastic locking nut	169101
Pressure plates		Art. No.
	Dia. 37 mm Three contact elements	215436
	Dia. 48.5 mm Four contact elements	215437
Holder for front installation		Art. No.
	8602/3 holder for cable duct	248673
Adaptor for front installation		Art. No.
	8602/3 Front installation for indicator lamp series 8010/6 and contact element series 8082/3	227038

Installation equipment

Mushroom stay-put button With key



8602C3-006-B .. MS1 Art. No. 223695

8082/3 Contact element

	Art. No.
 For NC front installation	240898
for NO contact front installation	240899

We reserve the right to make alterations to the technical data, dimensions, weights, designs and products available without notice. The illustrations cannot be considered binding.