

# Lighting

## Linear luminaire For fluorescent lamps

GRP

6401/542-8508-15-131 Art. No. 239553



- Can be used in Zone 2, 21 and 22
- Explosion-protected linear luminaire with two fluorescent lamps: 18 W, 36 W and 58 W
- Extremely robust: Impact strength rating of IK10

MY R. STAHL 6401A



The 6401 EXLUX luminaire is suited to normal indoor and outdoor lighting applications. In no time at all and with very little effort, using the accessories it can be fitted to the wall, ceiling or a pole, or alternatively, it can be suspended. The practical central lock is available with an optional switching element that disconnects the power supply at all poles when the plastic enclosure is opened. Lightweight yet strong: The high-quality workmanship makes this luminaire robust and minimises maintenance requirements.

### Technical Data

Explosion Protection	
Ex version	Yes
Application range (zones)	2 21 22
IECEX gas certificate	IECEX PTB 14.0035
IECEX gas explosion protection	Ex ec IIC T4 Gc
IECEX dust certificate	IECEX PTB 14.0035
IECEX dust explosion protection	Ex tb / tc IIIC T80 °C Db
ATEX gas certificate	PTB 14 ATEX 2017
ATEX gas explosion protection	⊕ II 3 G Ex ec IIC T4 Gc
ATEX dust certificate	PTB 14 ATEX 2016
ATEX dust explosion protection	⊕ II 2 D Ex tb / tc IIIC T80 °C Db
Certificates and approvals	ATEX IECEX
Certificates	ATEX (PTB), IECEX (PTB)
Electrical Data	
Rated operational voltage AC	220 – 240 V
Rated operational voltage DC	220 ... 240 V
Frequency range	50 – 60 Hz
Lighting Data	
Number of lamps	2
Lamp wattage	36 W
Lamp	G13 lamp base
Luminaire efficacy	0 lm/W
Luminous flux	0 lm

# Lighting

Linear luminaire For fluorescent lamps

GRP

6401/542-8508-15-131 Art. No. 239553



## Ambient Conditions

Ambient temperature	-30 °C ... +50 °C (T80 °C) Note: Through wiring Max. 3x16 A (T80 °C)
---------------------	--

## Mechanical Data

Version	Standard
IP degree of protection (IEC 60598)	IP66/IP67
Class	I (with inner PE connection)
Enclosure material	Polyester resin, Glass fibre reinforced
Enclosure colour	Light grey (RAL 7035)
Sealing material	Silicone
Silicone-free content	Contains silicone
Translucent cover material	Polycarbonate
Installed terminal strip	PE + N + L1 + L2 + L3
Max. solid connection terminals	6 mm <sup>2</sup>
Max. finely stranded connection terminals	4 mm <sup>2</sup>
Type of connection cable	Finely stranded Solid Stranded
Size	4
Width	184 mm
Height	125 mm
Length	1310 mm
Impact strength (IEC 62262)	IK10
Weight	5.5 kg
Weight	12.13 lb
Disconnection of the luminaire	No

## Components

Threaded plate	2x plastic
Ballast	ELXe
Through wiring	With 5 conductors 2.5 mm <sup>2</sup>
Drilled holes	3 x M25
Cable glands and entries	2 x M25 Ø 7 ...
Material cable gland	Polyamide, black
Stopping plugs	2 x M25 x 1.5
Stopping plug material	Polyamide, black
Accessories	Provided

# Lighting

Linear luminaire For fluorescent lamps

GRP

6401/542-8508-15-131 Art. No. 239553



## Light Distribution Curves

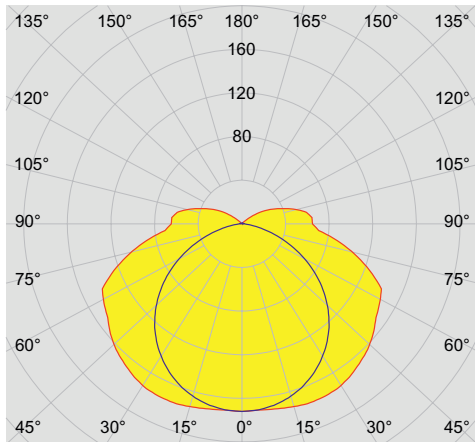

cd/klm 77%  
 — C0 - C180 — C90 - C270  
 2 x 36 W

## Dimensional Drawings (All Dimensions in mm [inches]) – Subject to Alterations

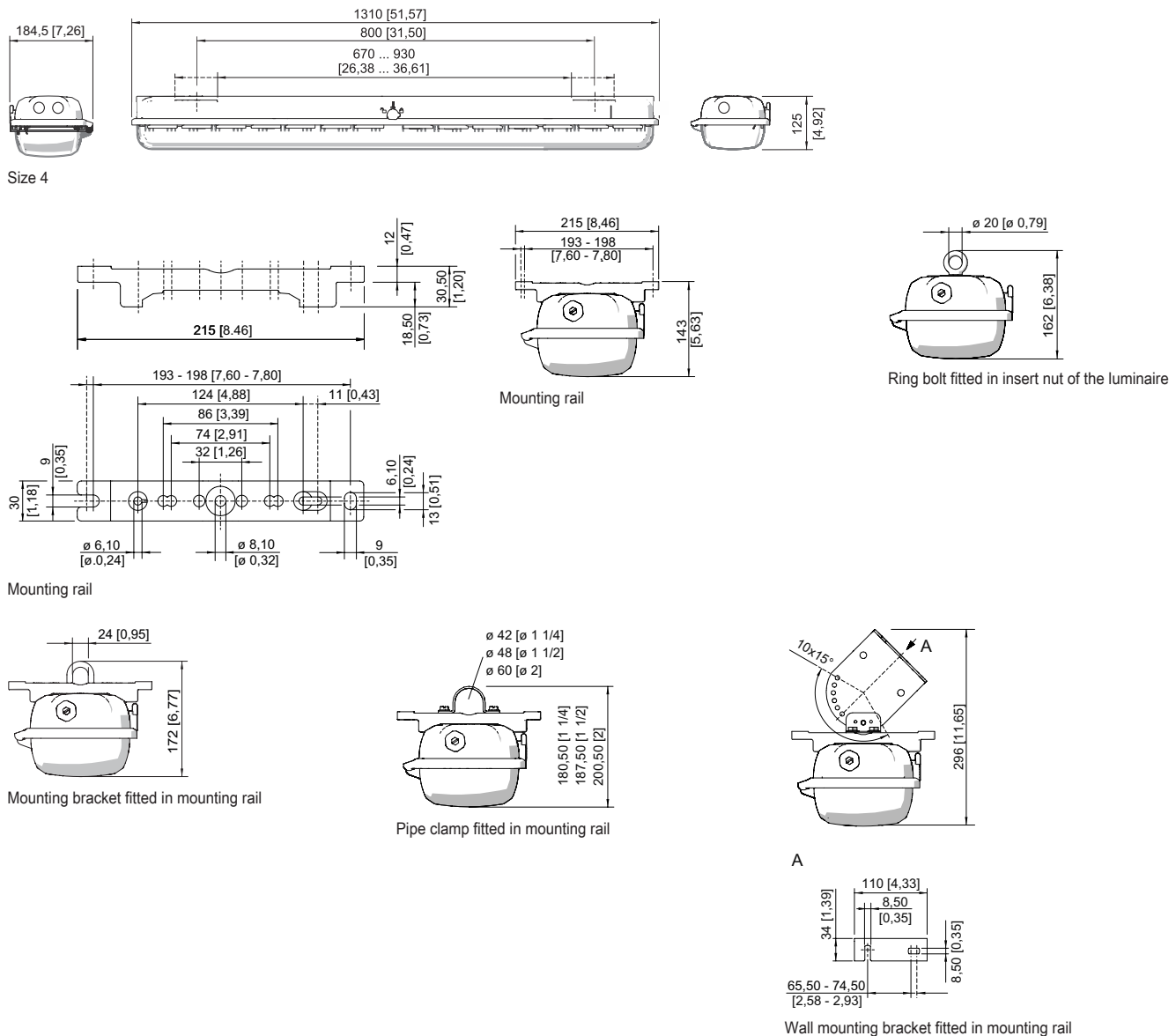

# Lighting





Linear luminaire For fluorescent lamps

GRP

6401/542-8508-15-131 Art. No. 239553

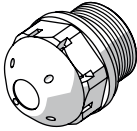
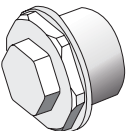
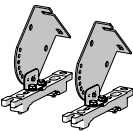

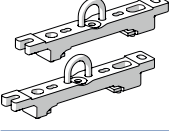
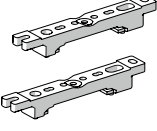
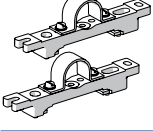
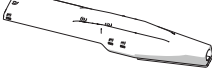
## Accessories

		Art. No.
<b>Breather</b>		
	Thread: M25 x 1.5; 20 pc; for installation in lights; in moulded material; without counter nut	138576
	Thread: M25 x 1.5 (1 piece); for installation in light fittings; made from stainless steel; without jam nut	296608
<b>Ceiling and wall mounting bracket</b>		
	mounted on a mounting rail for a variable mounting distance; Material: stainless steel; Lamp can be swiveled in steps of 15°; 1 pair	222827
<b>Holder for translucent cover</b>		
	The fall prevention system for the light fitting cover prevents the light fitting cover from falling accidentally when the light fitting is opened.	226791
<b>Mounting bracket</b>		
	mounting clamp mounted on a mounting rail for a variable mounting distance; 1 pair	222456
<b>Mounting rail</b>		
	for a variable mounting distance; 1 pair	222826
<b>Pipe clamp</b>		
	R 1 1/2"; with mounting rail for a variable mounting distance; material: stainless steel; 1 pair	222459
	R 1 1/4"; with mounting rail for a variable mounting distance; Material: stainless steel; 1 pair	222458
	R 2"; with mounting rail for a variable mounting distance; Material: stainless steel; 1 pair	222460
<b>Pole mounting sleeve</b>		
	for the subsequent mounting on lights size 2 and size 4, completely with assembly parts (for pipe diameter 42 mm)	227512
<b>Ring bolt</b>		
	M8, direct mounting in insert nuts; 1 pair	115736

# Lighting

Linear luminaire For fluorescent lamps

GRP

6401/542-8508-15-131 Art. No. 239553

STAHL

## Socket key

Art. No.

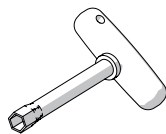

M8 / A/F 13;  
For actuating the central lock

222430

## Spare Parts

Art. No.

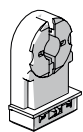

G13 lamp holder for light fittings with T8 fluorescent lamps for use in Zone 2 and for industrial applications (x 100 units)

107275

## Contact element

Art. No.

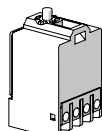

8080/1-3-L 2 NC contact element

132527

## Cover

Art. No.

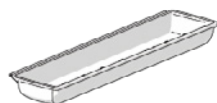

for luminaire size 4

222428

## Fluorescent lamp

Art. No.

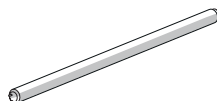

36 W, 3350 lm

108951

We reserve the right to make alterations to the technical data, dimensions, weights, designs and products available without notice. The illustrations cannot be considered binding.