



- Large selection of different actuators
- Versions as an NC with positive opening, NO or disconnect terminal

MY R. STAHL 8082D



R. STAHL Series 8082 contact elements have an NO contact and a positive opening operation NC contact, made from silver-nickel or gold-plated. They can be easily combined with contact blocks and enable customised installations, also due to the large selection of the various actuators.

Technical Data

Explosion Protection

Scope of validity	European Union (ATEX) CEC IECEX NEC
Application range (zones)	1 2
IECEX gas certificate	IECEX PTB 17.0037U
IECEX gas explosion protection	Ex db eb IIC T6 / T5 Gb
IECEX firedamp certificate	IECEX PTB 17.0037U
IECEX firedamp protection	Ex db eb I Mb
ATEX gas certificate	PTB 17 ATEX 1012 U
ATEX gas explosion protection	⊕ II 2 G Ex db eb IIC T6 / T5 Gb
ATEX firedamp certificate	PTB 17 ATEX 1012 U
ATEX firedamp protection	⊕ I M2 Ex db eb I Mb
UL gas certificate	E182378V1S9
Marking cULus	Class I, Div. 2, Groups A,B,C,D; Class I, Zone 1, AEx/Ex db eb IIC
Certificates	ATEX (PTB), Brazil (ULB), Canada (UL), China (CQST), IECEX (PTB), Korea (KTL), USA (UL)
Notes	Product label may vary. Series devices are labelled with ATEX, IECEX, NEC and CEC.

Electrical Data

Max. rated operational voltage	550 V
Min. rated operational voltage	24 V
Rated operational current	150 mA / 10 A
Rated operational current note	- Gold-plated contacts: 10 to 150 mA switching current - Silver-nickel contacts from 150 mA switching current. - For corrosive environments and offshore applications, we recommend the use of 8082 snap action switches.
Electrical service life	10 ⁹ operating cycles

Control Devices

Contact element For front installation NO

Ex e

8082/3-21-2-0 Art. No. 240899



Electrical Data

Mechanical service life	10 ⁶ operating cycles
Switching capacity AC-12	250 V / 10 A 400 V / 7.5 A 550 V / 5 A
Switching capacity AC-15	110 V / 10 A 250 V / 6 A 400 V / 4 A
Switching capacity DC-13	110 V / 1 A
Switching capacity DC-13<SoftReturn/>2 contact elements in series	60 V/6 A 110 V/2.5 A 250 V/1.25 A

Ambient Conditions

Ambient temperature	-60 °C ... +70 °C (T6) -60 °C ... +85 °C (T5)
Ambient temperature	-76 °F ... +158 °F (T6) -76 °F ... +185 °F (T5)
Ambient temperature NEC®	-60 °C ... +75 °C (T6) -60 °C ... +90 °C (T5)
Ambient temperature NEC®	-76°F ... +167°F (T6) -76°F ... +194°F (T5)
Operating temperature	-60 °C ... +100 °C
Operating temperature	-76 °F ... +212 °F
Operating temperature NEC	-60 °C ... +95 °C
Operating temperature NEC	-76 °F ... +203 °F

Mechanical Data

Degree of protection (IP) (IEC 60529)	IP20
Enclosure material	Polyamide
Contact material	Silver-nickel
Silicone-free	Yes
Max. connection cross-section, finely stranded	2,5 mm ²
Solid connection cross section	0.32 – 2.5 mm ²
Connection cross-section AWG single stranded	22 AWG to 14 AWG
Finely stranded connection cross section	0.32 – 2.5 mm ²
Finely stranded connection cross-section AWG	22 AWG to 14 AWG
Connection cross-section, finely stranded with core end sleeve	0.32 – 2.5 mm ²
Connection cross-section, finely stranded with core end sleeve AWG	AWG22 - AWG14
Number of NOs	1
Contacts	1 NO
Packaging unit	1
Weight	25 g
Weight	0.055 lb

Mounting / Installation

Tightening torque	1.2 Nm
-------------------	--------

Control Devices

Contact element For front installation NO

Ex e

8082/3-21-2-0 Art. No. 240899



Mounting / Installation

Tightening torque lbf in	10.62 lbf in
Connection type	Screw terminal

Dimensional Drawings (All Dimensions in mm [inches]) – Subject to Alterations

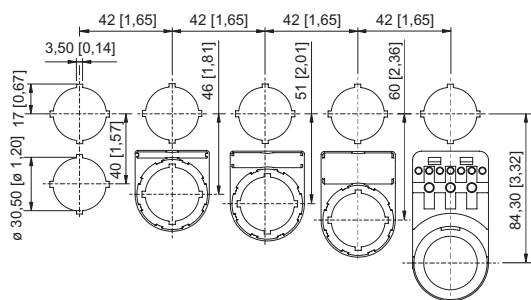
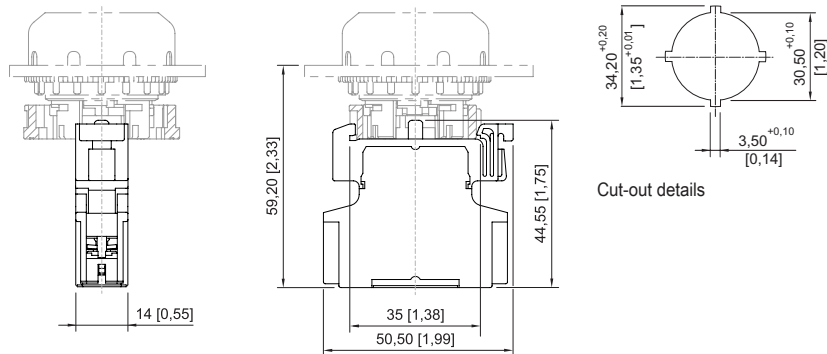

Cut-out with/without additional designation plate

Accessories

Pushbutton

		Art. No.
	Ø 39 mm Black Designation plate: Black, blank disc without text Silicone-free: Yes	223691
	Ø 39 mm Black Designation plate: Black, blank disc without text Silicone-free: No	223692

Mushroom pushbutton, black

		Art. No.
	Ø 39 mm Black Designation plate: Black, blank disc without text Silicone-free: Yes	244563
	Ø 39 mm Black Designation plate: Black, blank disc without text Silicone-free: No	244564

Control Devices

Contact element For front installation NO

Ex e

8082/3-21-2-0 Art. No. 240899





Mushroom pushbutton, red

		Art. No.
	Ø 39 mm Red/black Designation plate: Red, blank disc without text Silicone-free: Yes	244565
	Ø 39 mm Red/black Designation plate: Red, blank disc without text Silicone-free: No	244566

Mushroom stay-put button with key

		Art. No.
	Ø 39 mm Red/black Closing: MS1 Silicone-free: Yes	223695
	Ø 39 mm Red/black Closing: MS1 Silicone-free: No	223696

Key-operated switch actuator

		Art. No.
	Ø 39 mm Black Closing: MS1 Number of switching positions: 2 Switching function: Latching / Latching Silicone-free: No	244574
		Ø 39 mm Black Closing: MS1 Number of switching positions: 3 Switching function: Latching / Latching / Latching Silicone-free: No

Mushroom stay-put button with EM-STOP key

		Art. No.
	Ø 39 mm Yellow/red Designation plate: With yellow backing plate Closing: MS1 Silicone-free: Yes	223693
	Ø 39 mm Yellow/red Designation plate: With yellow backing plate Closing: MS1 Silicone-free: No	223694

Control Devices

Contact element For front installation NO

Ex e

8082/3-21-2-0 Art. No. 240899

STAHL

Mushroom stay-put button EM-STOP

		Art. No.
	Ø 39 mm Yellow/red Designation plate: With yellow backing plate Silicone-free: Yes	223697
	Ø 39 mm Yellow/red Designation plate: With yellow backing plate Silicone-free: No	223698

Mushroom stay-put button, black

		Art. No.
	Ø 39 mm Black Silicone-free: Yes	223699
	Ø 39 mm Black Silicone-free: No	223700

Mushroom pushbutton, 55 mm, red

		Art. No.
	Ø 55 mm Black/red Designation plate: Red, blank disc without text Silicone-free: Yes	244634
	Ø 55 mm Black/red Designation plate: Red, blank disc without text Silicone-free: No	244635

Mushroom stay-put button, 55 mm, EM-STOP

		Art. No.
	Ø 55 mm Yellow/red Designation plate: With yellow backing plate Silicone-free: Yes	244636

Mushroom stay-put button 55 mm EM-STOP

		Art. No.
	Ø 55 mm Yellow/red Designation plate: With yellow backing plate Silicone-free: No	244637

Twin pushbutton

		Art. No.
	Black Silicone-free: Yes	244638
	Black Silicone-free: No	244639

Control Devices

Contact element For front installation NO

Ex e

8082/3-21-2-0 Art. No. 240899



Mushroom pushbutton, 55 mm, black

		Art. No.
	Ø 55 mm Black Designation plate: Black, blank disc without text Silicone-free: Yes	244642
	Ø 55 mm Black Designation plate: Black, blank disc without text Silicone-free: No	244643

Small rotary actuator, not lockable

		Art. No.
	Ø 39 mm Black Designation plate: 0/OFF – I/ON Number of switching positions: 2 Lockable in: Not padlockable Switching function: Latching / Latching Silicone-free: Yes	244646

Small rotary actuator, not lockable

		Art. No.
	Ø 39 mm Black Designation plate: 0/OFF – I/ON Number of switching positions: 2 Lockable in: Not padlockable Switching function: Latching / Latching Silicone-free: No	244647

Small rotary actuator, not lockable

		Art. No.
	Ø 39 mm Black Designation plate: I – 0 – II Number of switching positions: 3 Lockable in: Not padlockable Switching function: Latching / Latching / Latching Silicone-free: Yes	244648
	Ø 39 mm Black Designation plate: I – 0 – II Number of switching positions: 3 Lockable in: Not padlockable Switching function: Latching / Latching / Latching Silicone-free: No	244649

Control Devices

Contact element For front installation NO

Ex e

8082/3-21-2-0 Art. No. 240899

STAHL

Rotary actuator, small, lockable

		Art. No.
	Ø 39 mm Black Designation plate: 0/OFF – I/ON Number of switching positions: 2 Lockable in: One pos. with one lock Switching function: Latching / Latching Silicone-free: Yes	244650
	Ø 39 mm Black Designation plate: 0/OFF – I/ON Number of switching positions: 2 Lockable in: One pos. with one lock Switching function: Latching / Latching Silicone-free: No	244651
	Ø 39 mm Black Designation plate: I – 0 – II Number of switching positions: 3 Lockable in: One pos. with one lock Switching function: Latching / Latching / Latching Silicone-free: Yes	244652
	Ø 39 mm Black Designation plate: I – 0 – II Number of switching positions: 3 Lockable in: One pos. with one lock Switching function: Latching / Latching / Latching Silicone-free: No	244653

Illuminated pushbutton (spring return)

		Art. No.
	Ø 39 mm Black All colours Silicone-free: Yes	244654
	Ø 39 mm Black All colours Silicone-free: No	244655

Spare Parts

Mushroom stay-put button with key

	Art. No.
--	----------

Control Devices

Contact element For front installation NO

Ex e

8082/3-21-2-0 Art. No. 240899



	Ø 39 mm Red/black Closing: MS2 Silicone-free: Yes	270409
	Ø 39 mm Red/black Closing: MS2 Silicone-free: No	270412
	Ø 39 mm Red/black Closing: MS3 Silicone-free: Yes	270410
	Ø 39 mm Red/black Closing: MS3 Silicone-free: No	270413
	Ø 39 mm Red/black Closing: MS4 Silicone-free: Yes	270411
	Ø 39 mm Red/black Closing: MS4 Silicone-free: No	270414

Control Devices

Contact element For front installation NO

Ex e

8082/3-21-2-0 Art. No. 240899



Key-operated switch actuator

BG008

Art. No.

		Art. No.
	Ø 39 mm Black Closing: MS1 Number of switching positions: 2 Switching function: Latching / Latching Silicone-free: Yes	244573
	Ø 39 mm Black Closing: MS2 Number of switching positions: 2 Switching function: Latching / Latching Silicone-free: Yes	272935
	Ø 39 mm Black Closing: MS2 Number of switching positions: 2 Switching function: Latching / Latching Silicone-free: No	270418
	Ø 39 mm Black Closing: MS3 Number of switching positions: 2 Switching function: Latching / Latching Silicone-free: Yes	274089
	Ø 39 mm Black Closing: MS3 Number of switching positions: 2 Switching function: Latching / Latching Silicone-free: No	270419
	Ø 39 mm Black Closing: MS4 Number of switching positions: 2 Switching function: Latching / Latching Silicone-free: Yes	272936
	Ø 39 mm Black Closing: MS4 Number of switching positions: 2 Switching function: Latching / Latching Silicone-free: No	270420

Control Devices

Contact element For front installation NO

Ex e

8082/3-21-2-0 Art. No. 240899



	<p>Ø 39 mm Black Closing: MS1 Number of switching positions: 3 Switching function: Latching / Latching / Latching Silicone-free: Yes</p>	244632
	<p>Ø 39 mm Black Closing: MS2 Number of switching positions: 3 Switching function: Latching / Latching / Latching Silicone-free: Yes</p>	274090
	<p>Ø 39 mm Black Closing: MS2 Number of switching positions: 3 Switching function: Latching / Latching / Latching Silicone-free: No</p>	270421
	<p>Ø 39 mm Black Closing: MS3 Number of switching positions: 3 Switching function: Latching / Latching / Latching Silicone-free: Yes</p>	274091
	<p>Ø 39 mm Black Closing: MS3 Number of switching positions: 3 Switching function: Latching / Latching / Latching Silicone-free: No</p>	270422
	<p>Ø 39 mm Black Closing: MS4 Number of switching positions: 3 Switching function: Latching / Latching / Latching Silicone-free: Yes</p>	274092
	<p>Ø 39 mm Black Closing: MS4 Number of switching positions: 3 Switching function: Latching / Latching / Latching Silicone-free: No</p>	270423

Control Devices

Contact element For front installation NO

Ex e

8082/3-21-2-0 Art. No. 240899

STAHL

Mushroom stay-put button with EM-STOP key

		Art. No.
	Ø 39 mm Yellow/red Designation plate: With yellow backing plate Closing: MS2 Silicone-free: Yes	274099
	Ø 39 mm Yellow/red Designation plate: With yellow backing plate Closing: MS2 Silicone-free: No	270415
	Ø 39 mm Yellow/red Designation plate: With yellow backing plate Closing: MS3 Silicone-free: Yes	274100
	Ø 39 mm Yellow/red Designation plate: With yellow backing plate Closing: MS3 Silicone-free: No	270416
	Ø 39 mm Yellow/red Designation plate: With yellow backing plate Closing: MS4 Silicone-free: Yes	274101
	Ø 39 mm Yellow/red Designation plate: With yellow backing plate Closing: MS4 Silicone-free: No	270417

Adaptor for front installation

		Art. No.
	8602/3 Front installation for indicator lamp series 8010/6 and contact element series 8082/3	227038

Holder for front installation

		Art. No.
	8602/3 holder for cable duct	248673

We reserve the right to make alterations to the technical data, dimensions, weights, designs and products available without notice. The illustrations cannot be considered binding.