

8602C3-023-S Art. No. 244639



- Pushbutton, mushroom pushbutton, mushroom stay-put button with key lock, mushroom stay-put button, twin pushbutton and illuminated pushbutton, rotary actuator, key-operated switch, potentiometer bezel and indicator lamp bezel
- One axial actuator can actuate up to four Series 8082 contact elements
- Key-operated switches and rotary switches codable at any time as "latching/spring return" or "key not removable"

MY R. STAHL 8602A



Thanks to their special technical features, the actuators from the 8602/3 series can withstand the most extreme conditions. In addition to the application option for use in ambient temperatures from -60 °C to +70 °C, the IP degree of protection, IP66, is maintained in accordance with EN 60529. It is also possible to actuate up to four contact elements from the 8082 series with a single axial actuator from the 8602/3 series.

The coding option of the key switches and rotary switches is innovative and one-of-a-kind. Integrated coding allows you to adjust the "latching/spring return" and/or "key not removable" functions at any time without additional accessories. A versatile set of accessories consisting of label holders and locking devices is available.

Technical Data

Explosion Protection

Application range (zones)	1 2 21 22
IECEX gas certificate	IECEX PTB 13.0047U
IECEX gas explosion protection	Ex eb IIC Gb
IECEX dust certificate	IECEX PTB 13.0047 U
IECEX dust explosion protection	Ex tb IIIC Db
ATEX gas certificate	PTB 13 ATEX 1019 U
ATEX gas explosion protection	Ex II 2 G Ex eb IIC Gb
ATEX dust certificate	PTB 13 ATEX 1019 U
ATEX dust explosion protection	Ex II 2 D Ex tb IIIC Db
UL gas certificate	E182378 V4 S2
Inmetro gas certificate	UL-BR 14.0380U
Inmetro dust certificate	UL-BR 14.0380U
Certificates	ATEX (PTB), Brazil (ULB), Canada / USA (UL), Canada (UL), IECEX (PTB), India (PESO), Korea (KGS)

Ambient Conditions

Ambient temperature	-60 °C ... +70 °C
Ambient temperature	-76 °F ... +158 °F
Storage temperature	-60 °C ... +70 °C
Storage temperature	-76 °F ... +158 °F
Use at the height of	< 2000 m

8602C3-023-S Art. No. 244639

Ambient Conditions

Degree of contamination	3
-------------------------	---

Mechanical Data

Degree of protection (IP)	IP66
Note on degree of protection	According to IEC/EN 60529
Enclosure material	Polyamide
Silicone-free	No
Assembly	023
Service life, min.	2 x 10 ⁵ actuations
Impact strength (IEC 60079)	7 J
Impact strength (IEC 62262)	min. IK08
Colour	Black
Fastening	Thread type
Seal	Silicone
Packaging unit	1
Weight	45 g
Weight	0.1 lb
Decription note	Select other labels from the accessories.

Mounting / Installation

Tightening torque	3 Nm
Tightening torque lbf in	26.55 lbf in

Technical Drawings – Subject to Alterations

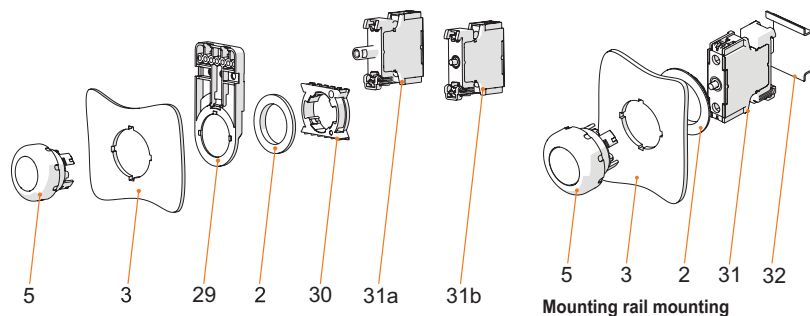

Front installation mounting with Series 8010/6 indicator lamp and Series 8082/3 contact element

Mounting rail mounting



Key

- 2 = jam nut (order no. 205592)
- 3 = installation wall (wall thickness max. 5 mm [0.197 inch])
- 5 = actuator with seal
- 29 = support for cable duct (optional) (order no. 248673)
- 30 = adaptor (order no. 227038)
- 31a = built-in element: LED element 8010/6
- 31b = built-in element: Contact element 8082/3

Key

- 2 = jam nut (order no. 205592)
- 3 = installation wall (wall thickness max. 5 mm [0.197 inch])
- 5 = actuator with seal
- 31 = built-in element
- 32 = TS35 mounting rail

8602C3-023-S Art. No. 244639

	Blue Text: RESET	227926
	Green Text: I	227750
	Green Text: II	227753

Designation plates for pushbutton and selector switch

Art. No.

	Green Text: START	227801
--	----------------------	--------

Designation plate for pushbutton and selector switch

Art. No.

	Red Text: STOP	227804
	Red Text: OFF	227810
	Red Text: OFF	227814
	Red Text: O	227740
	White Text: I	227751
	Black Blank disc without text	215425
	Blue Blank disc without text	215427

Installation equipment

Twin pushbutton



8602C3-023-S Art. No. 244639

	Green Blank disc without text	215424
	Red Blank disc without text	215423
	Red Symbol: Right arrow	272628
	White Blank disc without text	215426
	Yellow Blank disc without text	215428

Special key

Art. No.

	for tightening plastic locking nut	169101
--	------------------------------------	--------

Pressure plates

Art. No.

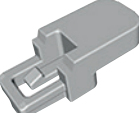
	For twin pushbutton Four contact elements	221706
--	--	--------

Holder for front installation

Art. No.

	8602/3 holder for cable duct	248673
--	------------------------------	--------

Adaptor for front installation

Art. No.

	8602/3 Front installation for indicator lamp series 8010/6 and contact element series 8082/3	227038
--	--	--------

8082/3 Contact element

Art. No.

	For NC front installation	240898
	for NO contact front installation	240899

Installation equipment

Twin pushbutton



8602C3-023-S Art. No. 244639

We reserve the right to make alterations to the technical data, dimensions, weights, designs and products available without notice. The illustrations cannot be considered binding.