

Installation equipment

Rotary actuator, small Padlockable



8602C3-727-S-M01-02-E08 Art. No. 244651



- Pushbutton, mushroom pushbutton, mushroom stay-put button with key lock, mushroom stay-put button, twin pushbutton and illuminated pushbutton, rotary actuator, key-operated switch, potentiometer bezel and indicator lamp bezel
- One axial actuator can actuate up to four Series 8082 contact elements
- Key-operated switches and rotary switches codable at any time as "latching/spring return" or "key not removable"

MY R. STAHL 8602A



Thanks to their special technical features, the actuators from the 8602/3 series can withstand the most extreme conditions. In addition to the application option for use in ambient temperatures from -60 °C to +70 °C, the IP degree of protection, IP66, is maintained in accordance with EN 60529. It is also possible to actuate up to four contact elements from the 8082 series with a single axial actuator from the 8602/3 series.

The coding option of the key switches and rotary switches is innovative and one-of-a-kind. Integrated coding allows you to adjust the "latching/spring return" and/or "key not removable" functions at any time without additional accessories. A versatile set of accessories consisting of label holders and locking devices is available.

Technical Data

Explosion Protection

| | |
|---------------------------------|--|
| Application range (zones) | 1 2 21 22 |
| IECEX gas certificate | IECEX PTB 13.0047U |
| IECEX gas explosion protection | Ex eb IIC Gb |
| IECEX dust certificate | IECEX PTB 13.0047 U |
| IECEX dust explosion protection | Ex tb IIIC Db |
| ATEX gas certificate | PTB 13 ATEX 1019 U |
| ATEX gas explosion protection | Ex II 2 G Ex eb IIC Gb |
| ATEX dust certificate | PTB 13 ATEX 1019 U |
| ATEX dust explosion protection | Ex II 2 D Ex tb IIIC Db |
| UL gas certificate | E182378 V4 S2 |
| Inmetro gas certificate | UL-BR 14.0380U |
| Inmetro dust certificate | UL-BR 14.0380U |
| Certificates | ATEX (PTB), Brazil (ULB), Canada / USA (UL), Canada (UL), IECEX (PTB), India (PESO), Korea (KGS) |

Ambient Conditions

| | |
|----------------------|--------------------|
| Ambient temperature | -60 °C ... +70 °C |
| Ambient temperature | -76 °F ... +158 °F |
| Storage temperature | -60 °C ... +70 °C |
| Storage temperature | -76 °F ... +158 °F |
| Use at the height of | < 2000 m |

Installation equipment

Rotary actuator, small Padlockable



8602C3-727-S-M01-02-E08 Art. No. 244651

Ambient Conditions

| | |
|-------------------------|---|
| Degree of contamination | 3 |
|-------------------------|---|

Mechanical Data

| | |
|-------------------------------|---|
| Version | lockable |
| Degree of protection (IP) | IP66 |
| Note on degree of protection | According to IEC/EN 60529 |
| Enclosure material | Polyamide |
| Silicone-free | No |
| Number of switching positions | 2 |
| Assembly | 727 |
| Diameter | 39 mm |
| Service life, min. | 10 ⁶ actuations |
| Impact strength (IEC 60079) | 7 J |
| Impact strength (IEC 62262) | min. IK08 |
| Colour | Black |
| Fastening | Thread type |
| Designation plate | 0/OFF – I/ON |
| Seal | Silicone |
| Lockable in | One pos. with one lock |
| Packaging unit | 1 |
| Weight | 40 g |
| Weight | 0.09 lb |
| Description note | Conversion to the "spring return" function is possible with the installed coding elements. Standard label enclosed separately. Different labels must be ordered in addition. Cylinder lock not enclosed. Pressure plates for 1–2 and 3–4 contact elements enclosed. |

Mounting / Installation

| | |
|--------------------------|--------------|
| Tightening torque | 3 Nm |
| Tightening torque lbf in | 26.55 lbf in |

Installation equipment

Rotary actuator, small Padlockable



8602C3-727-S-M01-02-E08 Art. No. 244651

Technical Drawings – Subject to Alterations

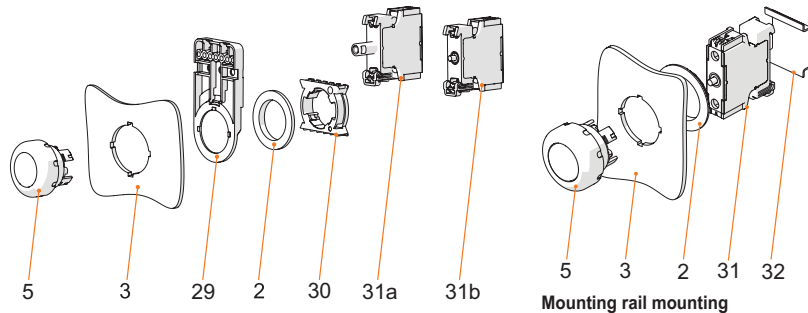

Front installation mounting with Series 8010/6 indicator lamp and Series 8082/3 contact element

Mounting rail mounting

Key

- 2 = jam nut (order no. 205592)
- 3 = installation wall (wall thickness max. 5 mm [0.197 inch])
- 5 = actuator with seal
- 29 = support for cable duct (optional) (order no. 248673)
- 30 = adaptor (order no. 227038)
- 31a = built-in element: LED element 8010/6
- 31b = built-in element: Contact element 8082/3

Key

- 2 = jam nut (order no. 205592)
- 3 = installation wall (wall thickness max. 5 mm [0.197 inch])
- 5 = actuator with seal
- 31 = built-in element
- 32 = TS35 mounting rail

Dimensional Drawings (All Dimensions in mm [inches]) – Subject to Alterations

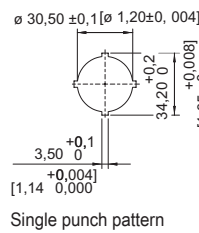
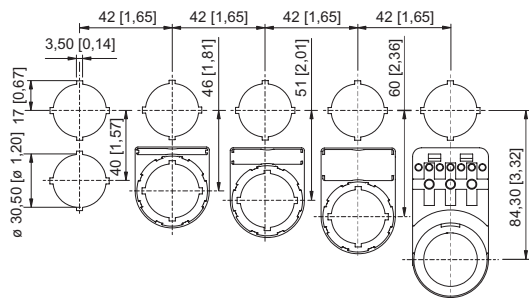

Single punch pattern

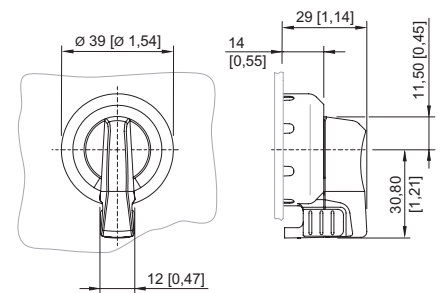

8602/3-727 axial rotary actuator, lockable
Actuator with axial actuation

Cut-out with/without additional designation plate

Accessories

Cylinder lock



for closing (bracket Ø 3)

Art. No.

107115

Spare Parts

Insert discs for label holder



One-line
Plain
Material: PVC
Colour: White
Self-adhesive

Art. No.



238271

Installation equipment

Rotary actuator, small Padlockable



8602C3-727-S-M01-02-E08 Art. No. 244651

| | | |
|--|--|--------|
|  | Two-line Plain Material: PVC Colour: White Self-adhesive | 238272 |
|  | Three-line Plain Material: PVC Colour: White Self-adhesive | 238273 |



Labels for small BG 732, BG 734 rotary actuator and BG 726, BG 727 axial rotary actuator

Art. No.

| | | |
|--|--------------------|--------|
|  | Dia. 30.8 Plain | 227495 |
|--|--------------------|--------|

Labels for axial BG 726, BG 727 rotary actuator

Art. No.

| | | |
|--|-------------------------|--------|
|  | Dia. 30.8 0/OFF I/ON | 240472 |
|  | Dia. 30.8 0 I | 240475 |



Closing part

Art. No.

| | | |
|--|---|--------|
|  | 8602C3-733-B for closing unused holes in cover, dia. 30.5 mm, NBR | 244306 |
| | 8602C3-733-S for closing unused holes in cover, dia. 30.5 mm, silicone | 244307 |

Label holder

Art. No.

| | | |
|--|---|--------|
|  | Size 1, without insert disc, 1-line label for actuators Ø 39 | 223566 |
|  | Size 2, without insert disc, 1- or 2-line label for actuators Ø 39 | 223567 |
|  | Size 3, without insert disc, 1-, 2- or 3-line label for actuators Ø 39 | 223568 |

Special key

Art. No.





| | | |
|--|------------------------------------|--------|
|  | for tightening plastic locking nut | 169101 |
|--|------------------------------------|--------|

Installation equipment

Rotary actuator, small Padlockable



8602C3-727-S-M01-02-E08 Art. No. 244651

| Pressure plates | | Art. No. |
|--|--|----------|
|  | For key-operated switch and axial rotary actuator 1 to 2 contact elements | 253627 |
|  | For key-operated switch and axial rotary actuator 3 to 4 contact elements | 221707 |
| Holder for front installation | | Art. No. |
|  | 8602/3 holder for cable duct | 248673 |
| Adaptor for front installation | | Art. No. |
|  | 8602/3 Front installation for indicator lamp series 8010/6 and contact element series 8082/3 | 227038 |
| 8082/3 Contact element | | Art. No. |
|  | For NC front installation | 240898 |
| | for NO contact front installation | 240899 |

We reserve the right to make alterations to the technical data, dimensions, weights, designs and products available without notice. The illustrations cannot be considered binding.