

# Signalling Devices



Visual signalling device LED continuous beacon

In flameproof enclosure

FX15/B-D-060-B-EN-SF-A-ST-00-00-00 Art. No. 247068



- Lamp: Flashing beacon – XENON (5 J) / continuous beacon – LED (6.5 W)
- Type of protection: Ex d
- Class: IP66/IP67 (IEC 60529 / NEMA 4X)
- Corrosion-resistant GRP enclosure
- Stainless steel protection cage included
- 8 light-intensifying Fresnel lens colours available to order
- Low weight (2.25 kg)

WebCode FX15A



**Product series FX15** provides visual signals from a continuous beacon with an LED or a 5 J flashing beacon with xenon flashes. The enclosure is made of glass fibre reinforced polyester. The product series is intended for use in hazardous areas and harsh environments.

## Technical Data

### Explosion Protection

Scope of validity	IECEX European Union (ATEX)
Application range (zones)	1 2 21 22
IECEX gas certificate	IECEX BAS 13.0005X
IECEX gas explosion protection	Ex d IIB T6 Gb
IECEX dust certificate	IECEX BAS 13.0005X
IECEX dust explosion protection	Ex tb IIIC T85 °C Db
ATEX gas certificate	Baseefa 13 ATEX 0007X
ATEX gas explosion protection	⊕ II 2 G Ex d IIB T6 Gb
ATEX dust certificate	Baseefa 13 ATEX 0007X
ATEX dust explosion protection	⊕ II 2 D Ex tb IIIC T85 °C Db
Certificates	ATEX (BAS), IECEX (BAS)

Temperature class	Max. surface temperature T	Ambient temperature range
T6	85 °C	-60 °C ... +70 °C
		...
		...

### Electrical Data

Rated operational voltage DC	24 V
Power	3.2 W
Tolerance	-10 – 10 %

### Lighting Data

Lamp	LED
Effective luminous intensity	20 cd

# Signalling Devices



Visual signalling device LED continuous beacon

In flameproof enclosure

FX15/B-D-060-B-EN-SF-A-ST-00-00-00 Art. No. 247068

## Lighting Data

Luminous flux	24 lm
---------------	-------

## Ambient Conditions

Ambient temperature	-60 °C ... +70 °C (T6)
---------------------	------------------------

Operating temperature	-60 °C ... +50 °C
-----------------------	-------------------

## Mechanical Data

Degree of protection (IP)	IP66
---------------------------	------

IP degree of protection (IEC 60529)	IP66/IP67
-------------------------------------	-----------

Enclosure material	Polyester (GRP), Glass fibre reinforced
--------------------	---

Enclosure colour	Black
------------------	-------

Sealing material	Red silicone 70
------------------	-----------------

Material dome	Polycarbonate, prismatic
---------------	--------------------------

Wire guard material	Stainless steel
---------------------	-----------------

Max. solid connection terminals	2.5 mm <sup>2</sup>
---------------------------------	---------------------

Max. finely stranded connection terminals	2.5 mm <sup>2</sup>
---	---------------------

Type of connection cable	Solid Finely stranded
--------------------------	--------------------------

Width	137 mm
-------	--------

Height	239 mm
--------	--------

Length	148 mm
--------	--------

Lens colour	Blue
-------------	------

Seal	O-ring seal
------	-------------

Weight	2.23 kg
--------	---------

Weight	4.92 lb
--------	---------

## Mounting / Installation

Connection type	Screw terminal
-----------------	----------------

Mounting part material	Stainless steel
------------------------	-----------------

## Components

Drilled holes	3 x M20
---------------	---------

Cable glands and entries	Can be ordered as accessories
--------------------------	-------------------------------

Stopping plugs	3 x dust cap
----------------	--------------

Wire guard	Yes
------------	-----

# Signalling Devices

Visual signalling device LED continuous beacon

In flameproof enclosure

FX15/B-D-060-B-EN-SF-A-ST-00-00-00 Art. No. 247068



Technical Drawings – Subject to Alterations

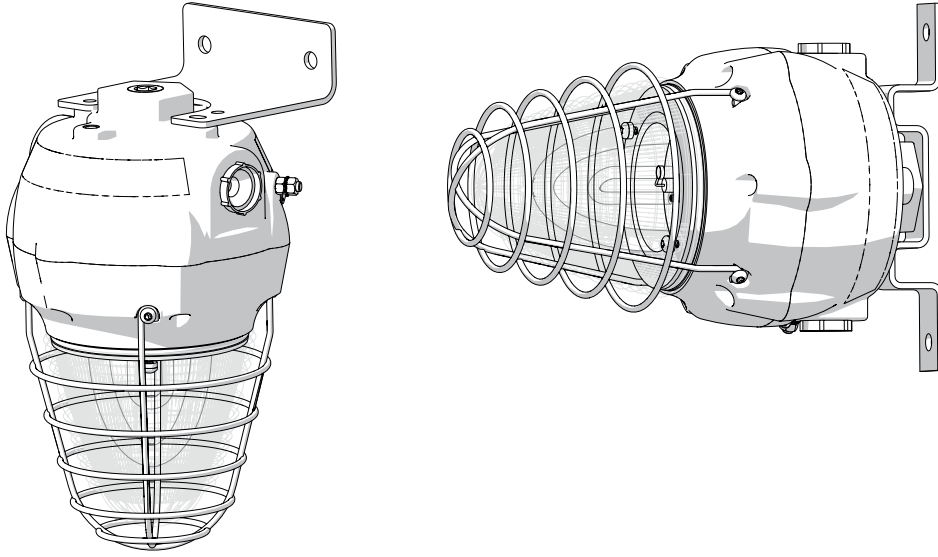

Dimensional Drawings (All Dimensions in mm [inches]) – Subject to Alterations

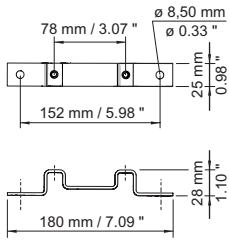

Backstrap bracket

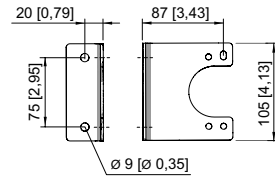

L-shaped bracket

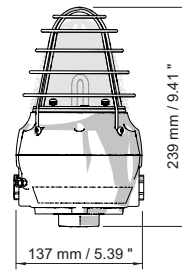
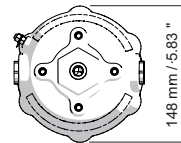

FX15 Beacon

# Signalling Devices



Visual signalling device LED continuous beacon

In flameproof enclosure

FX15/B-D-060-B-EN-SF-A-ST-00-00-00 Art. No. 247068

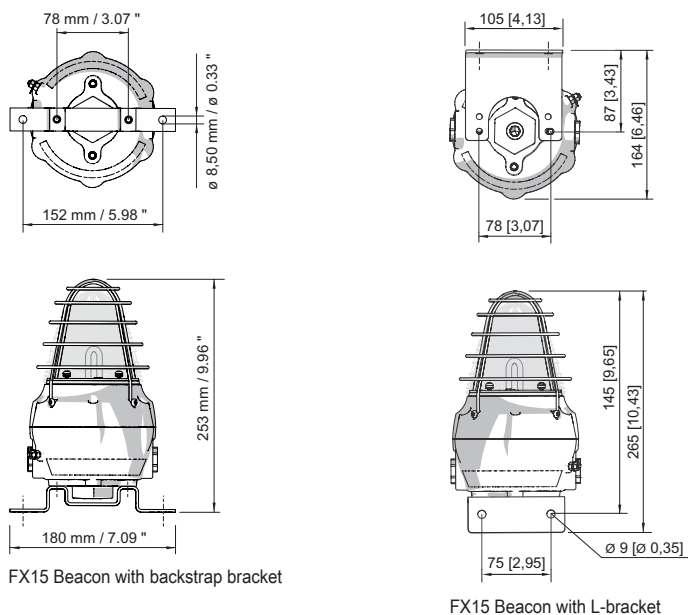







FX15 Beacon with backstrap bracket

FX15 Beacon with L-bracket

## Accessories

### Metal cable gland

		Art. No.
	Ex d & Ex e cable gland for all types of unarmoured and braid armour cables (nickel plated brass) Type 20A2F, M20 x 1.5	243464
	Ex d & Ex e cable entry with compound for all types of armoured cables (SWA, braided, tape) (nickel-plated brass) Type 20PX2K, M20 x 1.5	109428
	Ex d & Ex e Cable entry with RapidEx sealing system for all types of unarmoured and braid armour cables (nickel-plated brass) Type 20PX2K-REX, M20 x 1.5	246649
	Ex d & Ex e Cable entry with compound gland for all types of unarmoured and braid armour cables (nickel plated brass) Type 20PXSS2K, M20 x 1.5	109441
	Ex d & Ex e Cable entry with RapidEx sealing system for all types of unarmoured and braid armour cables (nickel-plated brass) Type 20PXSS2K-REX, M20 x 1.5	246605
	Ex d & Ex e cable gland for all types of armoured cables (SWA, braided, tape) (nickel plated brass) with unique compensating displacement seal system (CDS) Type 20T3CDS, M20 x 1.5	246561

### Stopping plugs

		Art. No.
	Stopping plug made of stainless steel M20x1,5 with external hexagon	251101

### Mounting accessories

		Art. No.
	Stainless steel L-bracket; standard — see dimensional drawings	221711



## Signalling Devices



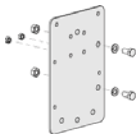

Visual signalling device LED continuous beacon

In flameproof enclosure

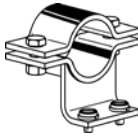
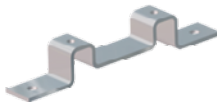
FX15/B-D-060-B-EN-SF-A-ST-00-00-00 Art. No. 247068

	Adapter plate for pipe clamp fastening (available for FL6S, FX15, YL6S)	256519
	Sun shield, stainless steel (available for FX15)	262077
	Pipe clamp, R 1 1/2"	120819
	Pipe clamp, R 1 1/4"	120812
	Pipe clamp, R 2"	120823
	Fastening bracket, stainless steel (available for FX15)	221712

## Spare Parts

Flange		Art. No.
	Flange, ATEX, blue (available for FL6S, FX15, YL6S)	243406
Fresnel lens		Art. No.
	Fresnel lens blue replacement	292141
	Fresnel lens red replacement	292147

We reserve the right to make alterations to the technical data, dimensions, weights, designs and products available without notice. The illustrations cannot be considered binding.