

Signalling devices



Audible signalling device Sounder

In flameproof enclosure

YA60/326-PS001-000030-ST000-0000 Art. No. 318589



- The latest generation of audible and visual alarm devices
- Ex d/Ex e connection chambers
- Audible solutions with directional or omnidirectional horn with up to 120 dB(A) at 1 m, 4 tone channels and 64 preconfigured tones
- Four output levels can be configured
- Brackets and fixings made from stainless steel
- Compliant with EN 54/DNV
- Fastening bracket included

MY R. STAHL YA60C



The **YA60/3 product series** provides audible alarm signals which can be used to alert, warn or draw attention to equipment malfunction/start-up or any number of safety-related issues in hazardous areas. The preconfigured signal tones provide a wide range of internationally standardised signal patterns, whereby four channels are available for each, enabling flexible use. The signalling devices meet the requirements of EN 54 and DNV for extremely challenging ambient conditions.

Technical Data

Explosion Protection

Scope of validity	European Union (ATEX) IECEX United Kingdom
Application range (zones)	1 2 21 22
IECEX gas certificate	IECEX EPS 22.0046X
IECEX gas explosion protection	Ex db eb IIC T6 / T4 Gb
IECEX dust certificate	IECEX EPS 22.0046X
IECEX dust explosion protection	Ex tb IIIC T80 °C / T100 °C Db
ATEX gas certificate	EPS 22 ATEX 1 224X
ATEX gas explosion protection	⊕ II 2 G Ex db eb IIC T6 / T4 Gb
ATEX dust certificate	EPS 22 ATEX 1 224X
ATEX dust explosion protection	⊕ II 2 D Ex tb IIIC T80 °C / T100 °C Db
Certificates	ATEX (BVIS), Brazil (ULB), IECEX (BVIS)
Declaration of Conformity	ATEX (EUK)

Electrical Data

Rated operational voltage DC	133 ... 272 V
Line monitoring	Yes
Tolerance	-10 ... 10 %
Frequency range	50 – 60Hz

Acoustic Data

Horn version	omnidirectional
Sound pressure level	max. 114 dB(A) @ 1 m
Sound level	4

Signalling devices



Audible signalling device Sounder

In flameproof enclosure

YA60/326-PS001-000030-ST000-0000 Art. No. 318589

Acoustic Data

Volume control	Max. -18 dB(A) adjustment
----------------	---------------------------

Lighting Data

Effective luminous intensity (1 Hz, flashing)	0 cd
---	------

Ambient Conditions

Ambient temperature	-40 °C ... 50 °C (T6) -40 °C ... 70 °C (T4)
---------------------	--

Storage temperature	-60 °C ... 70 °C
---------------------	------------------

Mechanical Data

IP degree of protection (IEC 60598)	IP66
-------------------------------------	------

Connection chamber version	Ex e
----------------------------	------

Enclosure material	Aluminium, powder-coated, Seawater-resistant
--------------------	--

Enclosure colour	red, similar to RAL 3020
------------------	--------------------------

Silicone-free content	Contains silicone
-----------------------	-------------------

Trumpet material	PC/PBT
------------------	--------

Max. solid connection terminals	4 mm ²
---------------------------------	-------------------

Max. finely stranded connection terminals	2.5 mm ²
---	---------------------

Width	176 mm
-------	--------

Height	319 mm
--------	--------

Length	128 mm
--------	--------

Fastening	Wall bracket
-----------	--------------

Weight	6.31 kg
--------	---------

Weight	13.91 lb
--------	----------

Mounting / Installation

Connection type	Push in
-----------------	---------

Mounting part material	Stainless steel
------------------------	-----------------

Components

Drilled holes	2 x M20 + 2 x M25
---------------	-------------------

Cable glands and entries	1 x M20 Ø 4 ... 13 mm 1 x M25 Ø 7 ...
--------------------------	--

Material cable gland	Polyamide, black
----------------------	------------------

Stopping plugs	2x M20 + 2x M25
----------------	-----------------

Stopping plug material	Polyamide, black
------------------------	------------------

Signalling devices

Audible signalling device Sounder

In flameproof enclosure

YA60/326-PS001-000030-ST000-0000 Art. No. 318589





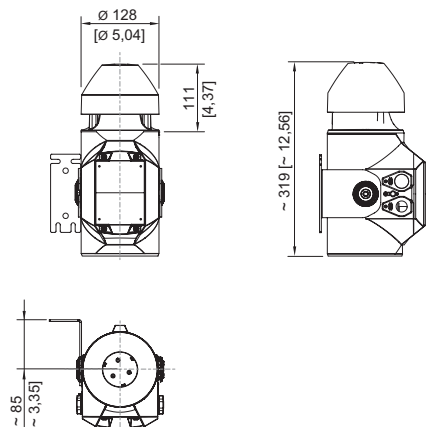

Dimensional Drawings (All Dimensions in mm [inches]) – Subject to Alterations



YA60/3 omnidirectional horn

Accessories

Metal cable gland		Art. No.
	Ex d and Ex e cable gland with compound for all types of armoured cables (SWA, wire-braid, tape) (nickel-plated brass) Type 20PX2K, M20 x 1.5	109428
	Ex d and Ex e cable glands with RapidEx sealing system for all types of unarmoured cables and wire-braid-armoured cables (nickel-plated brass) Type 20PX2K-REX, M20 x 1.5	246649
	Ex d and Ex e cable glands with compound for all types of unarmoured cables and wire-braid-armoured cables (nickel-plated brass) Type 20PXSS2K, M20 x 1.5	109441
	Ex d and Ex e cable glands with RapidEx sealing system for all types of unarmoured cables and wire-braid-armoured cables (nickel-plated brass) Type 20PXSS2K-REX, M20 x 1.5	246605
Cable gland made of plastic		Art. No.
	8161/7-M20-1304, Ex e Plastic, M20 x 1.5, cable outer diameter 4 to 13 mm Lot size 50 pieces	239156
Stopping plug		Art. No.
	8290/3-M20 Plastic, M20 x 1.5 Lot size 1 piece	143522
	8290/3-M20 Plastic, M20 x 1.5 Lot size 100 pieces	285773
Mounting accessories		Art. No.
	L-bracket, stainless steel 1.4404	319271

Signalling devices



Audible signalling device Sounder

In flameproof enclosure

YA60/326-PS001-000030-ST000-0000 Art. No. 318589

	U-bracket, stainless steel 1.4404	319280
--	-----------------------------------	--------

Spare Parts

Shaped horn		Art. No.
	directional, repair kit	319249
	omnidirectional, repair kit	319250
	omnidirectional, repair kit	319250

We reserve the right to make alterations to the technical data, dimensions, weights, designs and products available without notice. The illustrations cannot be considered binding.