

Signalling devices



Visual signalling device LED light fitting

In flameproof enclosure

FL60/326-D0801-00BW30-ST000-0000 Art. No. 319406



- The latest generation of audible and visual alarm devices
- Ex d/Ex e connection chambers
- Visual solutions with 5 to 21 J XENON and high-power LEDs with various light modes and 4 light channels
- Four output levels can be configured
- Brackets, fixings and protective grid made from stainless steel
- Compliant with EN 54/DNV
- Fastening bracket and protective cage included

MY R. STAHL FL60D



The **FL60/3 product series** provides visual alarm signals which can be used to alert, warn or draw attention to equipment malfunction/start-up or any number of safety-related issues in hazardous areas. The preconfigured light patterns (LED) provide a wide range of internationally standardised signal patterns, whereby four channels are available for each, enabling flexible use. The signalling devices meet the requirements of EN 54 and DNV for extremely challenging ambient conditions.

Technical Data

Explosion Protection

| | |
|---------------------------------|--|
| Scope of validity | European Union (ATEX) IECEX United Kingdom |
| Application range (zones) | 1 2 21 22 |
| IECEX gas certificate | IECEX EPS 22.0046X |
| IECEX gas explosion protection | Ex db eb IIC T6 / T4 Gb |
| IECEX dust certificate | IECEX EPS 22.0046X |
| IECEX dust explosion protection | Ex tb IIIC T80 °C / T100 °C Db |
| ATEX gas certificate | EPS 22 ATEX 1 224X |
| ATEX gas explosion protection | ⊕ II 2 G Ex db eb IIC T6 / T4 Gb |
| ATEX dust certificate | EPS 22 ATEX 1 224X |
| ATEX dust explosion protection | ⊕ II 2 D Ex tb IIIC T80 °C / T100 °C Db |
| Certificates | ATEX (BVIS), IECEX (BVIS) |
| Declaration of Conformity | ATEX (EUK) |

Electrical Data

| | |
|------------------------------|-----------------|
| Rated operational voltage DC | 21.1 ... 27.2 V |
| Line monitoring | Yes |
| Tolerance | -10 ... 10 % |

Lighting Data

| | |
|---|------------------------|
| Lamp | LED dome light fitting |
| Effective luminous intensity (1 Hz, flashing) | 95 cd |

Signalling devices



Visual signalling device LED light fitting

In flameproof enclosure

FL60/326-D0801-00BW30-ST000-0000 Art. No. 319406

Ambient Conditions

| | |
|---------------------|--|
| Ambient temperature | -40 °C ... 40 °C (T6) -40 °C ... 70 °C (T4) |
| Storage temperature | -60 °C ... 70 °C |

Mechanical Data

| | |
|---|--|
| IP degree of protection (IEC 60598) | IP66/67 |
| Connection chamber version | Ex e |
| Enclosure material | Aluminium, powder-coated, Seawater-resistant |
| Enclosure colour | red, similar to RAL 3020 |
| Silicone-free content | Contains silicone |
| Material dome | Polycarbonate, prismatic |
| Material glas dome | Polycarbonate, prismatic |
| Protective collar material | Polycarbonate (PC cover) |
| Wire guard material | Stainless steel |
| Max. solid connection terminals | 4 mm ² |
| Max. finely stranded connection terminals | 2.5 mm ² |
| Clamping range | 0.5 ... 4 mm |
| Width | 176 mm |
| Height | 317 mm |
| Length | 128 mm |
| Lens colour | Blue |
| Fastening | Wall bracket |
| Weight | 5.56 kg |
| Weight | 12.26 lb |

Mounting / Installation

| | |
|------------------------|-----------------|
| Connection type | Push in |
| Mounting part material | Stainless steel |

Components

| | |
|--------------------------|--|
| Drilled holes | 2 x M20 + 2 x M25 |
| Cable glands and entries | 1 x M20 Ø 4 ... 13 mm 1 x M25 Ø 7 ... |
| Material cable gland | Polyamide, black |
| Stopping plugs | 2x M20 + 2x M25 |
| Stopping plug material | Polyamide, black |

Signalling devices

Visual signalling device LED light fitting

In flameproof enclosure

FL60/326-D0801-00BW30-ST000-0000 Art. No. 319406



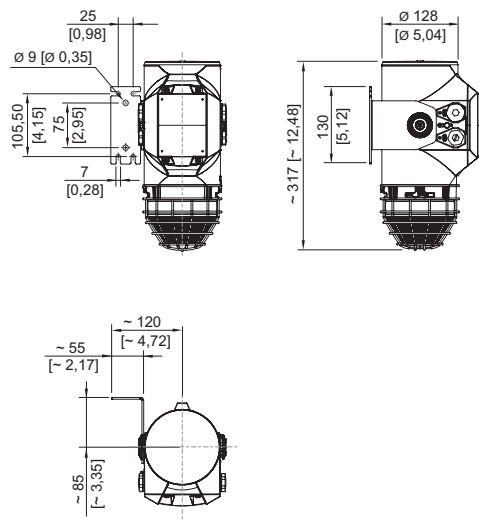

Dimensional Drawings (All Dimensions in mm [inches]) – Subject to Alterations



Accessories

Metal cable gland

| | | Art. No. |
|--|--|----------|
|  | Ex d and Ex e cable gland with compound for all types of armoured cables (SWA, wire-braid, tape) (nickel-plated brass) Type 20PX2K, M20 x 1.5 | 109428 |
| | Ex d and Ex e cable glands with RapidEx sealing system for all types of unarmoured cables and wire-braid-armoured cables (nickel-plated brass) Type 20PX2K-REX, M20 x 1.5 | 246649 |
|  | Ex d and Ex e cable glands with compound for all types of unarmoured cables and wire-braid-armoured cables (nickel-plated brass) Type 20PXSS2K, M20 x 1.5 | 109441 |
| | Ex d and Ex e cable glands with RapidEx sealing system for all types of unarmoured cables and wire-braid-armoured cables (nickel-plated brass) Type 20PXSS2K-REX, M20 x 1.5 | 246605 |

Cable gland made of plastic

| | | Art. No. |
|--|--|----------|
|  | 8161/7-M20-1304, Ex e Plastic, M20 x 1.5, cable outer diameter 4 to 13 mm Lot size 50 pieces | 239156 |

Stopping plug

| | | Art. No. |
|--|---|----------|
|  | 8290/3-M20 Plastic, M20 x 1.5 Lot size 1 piece | 143522 |
| | 8290/3-M20 Plastic, M20 x 1.5 Lot size 100 pieces | 285773 |

Mounting accessories

| | | Art. No. |
|--|-----------------------------------|----------|
|  | L-bracket, stainless steel 1.4404 | 319271 |

Signalling devices



Visual signalling device LED light fitting

In flameproof enclosure

FL60/326-D0801-00BW30-ST000-0000 Art. No. 319406

| | | |
|--|-----------------------------------|--------|
|  | U-bracket, stainless steel 1.4404 | 319280 |
|--|-----------------------------------|--------|

Protective cage

Art. No.

| | | |
|--|---|--------|
|  | Protective cage, stainless steel 1.4404 | 319272 |
|--|---|--------|

Spare Parts

Textured lens

Art. No.

| | | |
|--|------|--------|
|  | blue | 319274 |
|--|------|--------|

We reserve the right to make alterations to the technical data, dimensions, weights, designs and products available without notice. The illustrations cannot be considered binding.