

8595/1-CS2-S-S25-00E Art. No. 324649



- Simple handling using hot swap technology
- Versatile application possibilities thanks to modular structure
- Most extreme operating conditions in hazardous areas
- Reliable data and signal connections or power supplies
- Simple connection and disconnection thanks to one-handed operation

### MY R. STAHL 8595H



R. STAHL's Series 8595/1 explosion-protected miniCON plug connectors with up to eight poles keep you safely connected. The high-quality stainless steel plug connectors have impressed many customers with their reliability in a diverse range of applications. Their hot swap disconnecting capacity means that intrinsically safe signal supplies and power supplies up to 500 V/8 A can be connected and disconnected reliably and safely without the need for a hot work permit or other hot work authorisation.

The miniCON connectors designed for conductor cross-sections of 24 AWG to 14 AWG (0.25 mm<sup>2</sup> to 2.5 mm<sup>2</sup>) are available for directly connecting electrical lines or for device installation in the device plug and flange socket types of construction. The new plug connectors for hazardous areas in Class I, II, Division 2 and in Zones 1 and 21 stand out from the competition thanks to their modular structure and logically arranged components, which enable quick, easy mounting. Our patented single-handed operation means that matching plug connectors, which can be defined by the installer using internal coding for up to three applications, can be connected in no time. If required, nickel-plated brass versions are available.

## Technical Data

### Explosion Protection

Area of application	European Union (ATEX) CE Code IECEX NEC®
Application range (zones)	1, 2, 21, 22
IECEX gas certificate	IECEX EPS 20.0035X
IECEX gas certificate	IECEX EPS 20.0035X
IECEX gas explosion protection	Ex db eb IIC T6 / T5 Gb
IECEX dust certificate	IECEX EPS 20.0035X
IECEX dust explosion protection	Ex tb IIIC T80 °C / T95 °C Db
ATEX gas certificate	EPS 20 ATEX 1075 X
ATEX gas certificate	EPS 20 ATEX 1075 X
ATEX gas explosion protection	⊕ II 2 G Ex db eb IIC T6 / T5 Gb
ATEX dust certificate	EPS 20 ATEX 1075 X
ATEX dust explosion protection	⊕ II 2 D Ex tb IIIC T80 °C / T95 °C Db
Certificate ULus	E531347

8595/1-CS2-S-S25-00E Art. No. 324649

### Explosion Protection

Marking ULus	Class I, Div. 2, Groups A,B,C,D Class II, III, Div. 2, Groups F,G Class I, Zone 1, AEx db eb IIC Gb Class I, Zone 0, AEx ia IIC Ga Zone 21, AEx tb IIIC Db Zone 20, AEx ia IIIC Da
Certificate cUL	E531347
Marking cUL	Ex db eb IIC T6,T5 Gb Ex ia IIC T6 Ga Ex tb IIIC T80 °C ... T95 °C Db Ex ia IIIC T80 °C Da Class I, Div. 2, Groups A,B,C,D Class II, III, Div. 2, Groups F,G
Certificates	ATEX (EPS), Canada (UL), IECEx (EPS), USA (UL)
Declaration of conformity	ATEX (EUK)

### Electrical Data

Rated operational voltage AC	500 V
Voltage tolerance	+10%
Rated insulation voltage	690 V
Rated operational current for AC	8 A
Switching capacity	AC-3: 550 V/8 A
No. of poles	7
No. of poles	7 P + PE / 8 P
AC frequency range	50 – 60 Hz
Notes	Data transfer rate: 1000 Mbps

### Device Specific Data

Back-up fuse with thermal protection	25 A GL
Back-up fuse without thermal protection	16 A GL

### Ambient Conditions

Ambient temperature	-60 °C ... 75 °C
Ambient temperature	-76 °F ... +167 °F

### Mechanical Data

Version	Ex e flange socket
Degree of protection (IP) (IEC 60529)	IP66 IP67
IP degree of protection (IEC 60079)	IP64
Enclosure type (UL50 & UL50E)	3, 4, 4X
Base part	Coupling
Enclosure material	Stainless steel 1.4404
Contact type	Socket contact
Connection cross-section	2.5 mm <sup>2</sup>
Connection cross-section 2	1.5 mm <sup>2</sup>
Connection cross-section AWG	14 AWG
Connection cross-section AWG	16 AWG
Connection cross-section 2 min.	1.5 mm <sup>2</sup>
Connection cross-section 2 max.	1.5 mm <sup>2</sup>
Connection cross-section 2 AWG min.	16 AWG

8595/1-CS2-S-S25-00E Art. No. 324649

### Mechanical Data

Connection cross-section 2 AWG max.	16 AWG
Connection thread	M32 x 1.5
Impact strength (IEC 60079)	7 J
Coding	1-3, arbitrary
Seal	Silicone
Weight	200 g
Weight	0.44 lb

### Mounting / Installation

Connection type	crimp
Connection type 2	solder

### Components

Protective cap available	Yes
--------------------------	-----

### Technical Drawings – Subject to Alterations

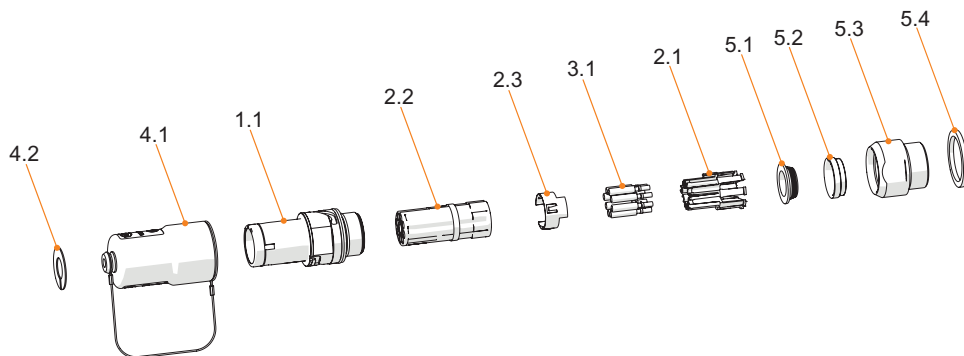

- 4.2 Code disk
- 4.1 Protective cap
- 1.1 Coupling basic part
- 2.2 Insulator
- 2.3 PE contact (only for metal variant)
- 3.1 Contacts
- 2.1 Contact holder
- 5.1 Earthing ring
- 5.2 Clamping disc
- 5.3 Ex e adapter
- 5.4 Seal

### Dimensional Drawings (All Dimensions in mm [inches]) – Subject to Alterations

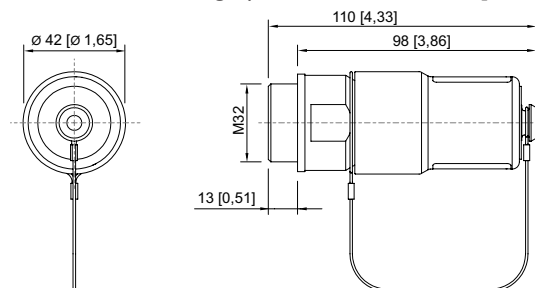

8595/1 Ex e flange socket

### Accessories

#### EMC/shielding

Art. No.

8595/1-CS2-S-S25-00E Art. No. 324649

	To create an EMC-compliant connection of braided, shielded or reinforced conductors.	307512
--	--	--------

Plug	Art. No.	
	Enclosure material: Stainless steel 1.4404 Contact type: Pin contact Connection cross-section: 2.5 mm <sup>2</sup> Number of poles: 7 P + PE/8 P Connection type: Crimping	324651

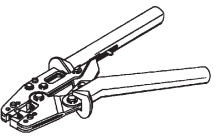
Crimping tool	Art. No.	
	For all versions with crimp connection of 0.14 to 6 mm <sup>2</sup>	295689

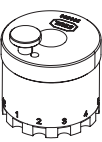
Contact mounts/positioners for rotated industrial contacts	Art. No.	
	The selection of the contact mount is based on the crimp contacts to be processed. - Exact positioning of the crimp contact during the crimping process - Reliable, reproducible crimping result - Adapted for miniCON contacts	299586

Adaptor	Art. No.	
	KIT 8595 stainless steel adaptor, M20 x 1.5, for installation in Ex e enclosure	304565
	KIT 8595 stainless steel adaptor, M25 x 1.5, for installation in Ex e enclosure	304567

Socket contact	Art. No.	
	KIT 8595 socket contacts (2.5 mm <sup>2</sup> ), 8 pieces	286154

## Spare Parts

Jam nut, nickel-plated brass	Art. No.	
	Material: Nickel-plated brass    One piece Thread size: M32	110869

Contact holder for socket contact	Art. No.	
	KIT 8595 socket contact insert + PE	286146

8595/1-CS2-S-S25-00E Art. No. 324649

**Protective cap**

**Art. No.**



KIT 8595 coupling protective cap (socket)  
Incl. KIT 8595 coding plates, four colours, without labelling

286159

We reserve the right to make alterations to the technical data, dimensions, weights, designs and products available without notice. The illustrations cannot be considered binding.