

Installation equipment

Rotary actuator, small Not padlockable



8602C3-732-S-90G-E08 Art. No. 264002



- Pushbutton, mushroom pushbutton, mushroom stay-put button with key lock, mushroom stay-put button, twin pushbutton and illuminated pushbutton, rotary actuator, key-operated switch, potentiometer bezel and indicator lamp bezel
- One axial actuator can actuate up to four Series 8082 contact elements
- Key-operated switches and rotary switches codable at any time as "latching/spring return" or "key not removable"

MY R. STAHL 8602A



Thanks to their special technical features, the actuators from the 8602/3 series can withstand the most extreme conditions. In addition to the application option for use in ambient temperatures from -60 °C to +70 °C, the IP degree of protection, IP66, is maintained in accordance with EN 60529. It is also possible to actuate up to four contact elements from the 8082 series with a single axial actuator from the 8602/3 series.

The coding option of the key switches and rotary switches is innovative and one-of-a-kind. Integrated coding allows you to adjust the "latching/spring return" and/or "key not removable" functions at any time without additional accessories. A versatile set of accessories consisting of label holders and locking devices is available.

Technical Data

Explosion Protection

Application range (zones)	1 2 21 22
IECEX gas certificate	IECEX PTB 13.0047U
IECEX gas explosion protection	Ex eb IIC Gb
IECEX dust certificate	IECEX PTB 13.0047 U
IECEX dust explosion protection	Ex tb IIIC Db
ATEX gas certificate	PTB 13 ATEX 1019 U
ATEX gas explosion protection	Ex II 2 G Ex eb IIC Gb
ATEX dust certificate	PTB 13 ATEX 1019 U
ATEX dust explosion protection	Ex II 2 D Ex tb IIIC Db
UL gas certificate	E182378 V4 S2
Inmetro gas certificate	UL-BR 14.0380U
Inmetro dust certificate	UL-BR 14.0380U
Certificates	ATEX (PTB), Brazil (ULB), Canada / USA (UL), Canada (UL), IECEX (PTB), India (PESO), Korea (KGS)

Ambient Conditions

Ambient temperature	-60 °C ... +70 °C
Ambient temperature	-76 °F ... +158 °F
Storage temperature	-60 °C ... +70 °C
Storage temperature	-76 °F ... +158 °F
Use at the height of	< 2000 m

Installation equipment

Rotary actuator, small Not padlockable



8602C3-732-S-90G-E08 Art. No. 264002

Ambient Conditions

Degree of contamination	3
-------------------------	---

Mechanical Data

Version	not lockable
Degree of protection (IP)	IP66
Note on degree of protection	According to IEC/EN 60529
Enclosure material	Polyamide
Silicone-free	No
Assembly	732
Diameter	39 mm
Service life, min.	10 ⁵ actuations
Impact strength (IEC 60079)	7 J
Impact strength (IEC 62262)	min. IK08
Colour	Black
Fastening	Thread type
Designation plate	0/OFF – I/ON
Seal	Silicone
Lockable in	Not padlockable
Packaging unit	1
Weight	40 g
Weight	0.09 lb
Description note	Label 0/OFF-I/ON enclosed separately. Different labels must be ordered separately.

Mounting / Installation

Tightening torque	3 Nm
Tightening torque lbf in	26.55 lbf in

Technical Drawings – Subject to Alterations

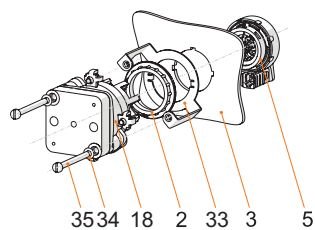

Front installation mounting with Series 8008 control switch

Key

2 = jam nut (order no. 205592)

3 = installation wall (wall thickness max. 2 mm [0.0787 inch])

5 = 8302/3 actuator with seal (4)

18 = 8008/2- control switch

33 = front installation 8602/3 adaptor for type 8008/2

34 = M4 disc

35 = M4x screw

Installation equipment

Rotary actuator, small Not padlockable



8602C3-732-S-90G-E08 Art. No. 264002

Dimensional Drawings (All Dimensions in mm [inches]) – Subject to Alterations

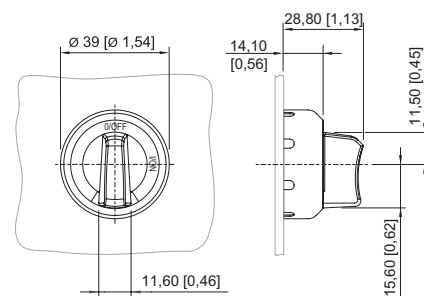
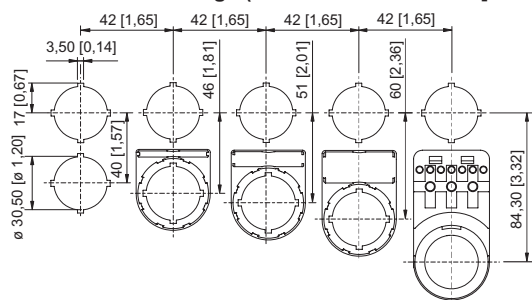

Cut-out with/without additional designation plate

8602/3-732 rotary actuator, not lockable
Actuator with radial actuation

Spare Parts

Insert discs for label holder

		Art. No.
	One-line Plain Material: PVC Colour: White Self-adhesive	238271
	Two-line Plain Material: PVC Colour: White Self-adhesive	238272
	Three-line Plain Material: PVC Colour: White Self-adhesive	238273

Labels for small BG 732, BG 734 rotary actuator



		Art. No.
	Dia. 30.8 0/OFF I/ON	227489
	Dia. 30.8 0 I	227490
	Dia. 30.8 I 0 II	227491
	Dia. 30.8 0 I	227492
	Dia. 30.8 MANUAL 0 AUTO	227494

Installation equipment

Rotary actuator, small Not padlockable







8602C3-732-S-90G-E08 Art. No. 264002

	Dia. 30.8 OFF ON	269983
	Dia. 30.8 AUTO 0 MANUAL ON	269984
	Dia. 30.8 AUTO 0 MANUAL	269985

Labels for small BG 732, BG 734 rotary actuator and BG 726, BG 727 axial rotary actuator		Art. No.
	Dia. 30.8 Plain	227495

Closing part		Art. No.
	8602C3-733-B for closing unused holes in cover, dia. 30.5 mm, NBR	244306
	8602C3-733-S for closing unused holes in cover, dia. 30.5 mm, silicone	244307

Label holder		Art. No.
	Size 1, without insert disc, 1-line label for actuators Ø 39	223566
	Size 2, without insert disc, 1- or 2-line label for actuators Ø 39	223567
	Size 3, without insert disc, 1-, 2- or 3-line label for actuators Ø 39	223568

Special key		Art. No.
	for tightening plastic locking nut	169101

Adaptor for front installation		Art. No.
	8602/3 front installation for control switch of Series 8008	260081

Installation equipment

Rotary actuator, small Not padlockable



8602C3-732-S-90G-E08 Art. No. 264002

We reserve the right to make alterations to the technical data, dimensions, weights, designs and products available without notice. The illustrations cannot be considered binding.