

8060/2-4-R-60 Art. No. 268417



- Large temperature range of use
- Plastic Ex e enclosure
- Degree of protection IP66/67
- Five different contact versions
- Different actuator versions which can be repositioned by 4 x 90°
- Can also be used as simple apparatus

MY R. STAHL 8060B



Position switches are used to position, control and monitor the moving parts on machines and systems. Because they meet the requirements of the EN 50 047 and IEC 60947-5-1 product standards, they can also be used as a position switch with a safety function. Series 8060/2 position switches are approved for use in hazardous areas of Zones 1, 2, 21 and 22.

In conjunction with a safety door guard and the corresponding circuitry, the PL position switches fulfil the requirements of “e” in accordance with EN ISO 13849-1, or up to SIL 3 in accordance with EN 62061. They are identified with the ⊖ character to signify positive opening. There are snap- and slow-action versions with different types of contacts as well as with a variety of different actuating elements.

Technical Data

Explosion Protection

Area of application	European Union (ATEX)
Application range (zones)	1, 2, 21, 22
IECEX gas certificate	IECEX BVS 16.0066
IECEX gas explosion protection	Ex db eb IIC T6 Gb
IECEX dust certificate	IECEX BVS 16.0066
IECEX dust explosion protection	Ex tb IIIC T80 °C Db
ATEX gas certificate	BVS 16 ATEX E 100
ATEX gas explosion protection	⊖ II 2 G Ex db eb IIC T6 Gb
ATEX dust certificate	BVS 16 ATEX E 100
ATEX dust explosion protection	⊖ II 2 D Ex tb IIIC T80 °C Db
Certificates	ATEX (BVS), Canada (CSA), China (CQST), IECEX (BVS), India (PESO), Korea (KGS), USA (CSA)
Declaration of conformity	ATEX (EUK), ATEX (Simple apparatus), Declaration of Conformity (ATEX)

Electrical Data

DC rated operational voltage	125 V
AC operating voltage (equal potential)	400 V
AC operating voltage (unequal potential)	250 V
Rated insulation voltage	500 V
Rated insulation voltage note	(for simple apparatus: 40 V)
Rated operational current max.	4 A
Rated operational current note	(for simple apparatus: 200 mA; inductance L_i and capacitance C_i are negligible)
Electrical service life	Max. 10 ⁶ operating cycles

8060/2-4-R-60 Art. No. 268417

Electrical Data

Mechanical service life	Max. 10 ⁶ operating cycles
Rated surge voltage	6 kV
Max. short-circuit protection	6 A
Tripping characteristic	gL/gG
Maximum operating frequency	1800 operating cycles/h
Switching function	Slow-action contact

Ambient Conditions

Ambient temperature	-60 °C ... +55 °C (Max. 4 A) -60 °C ... +60 °C (Max. 2 A)
---------------------	--

Mechanical Data

Version	2nd generation
Degree of protection (IP)	IP66
Degree of protection (IP) IEC 60529) note	down to -20 °C
Degree of protection (IP) (IEC 60529)	IP67
Enclosure material	Thermoplast GF, impact resistant
Enclosure colour	Black
Cover material	Duroplast GF, impact resistant
Contact material	Silver-nickel
Solid connection cross section	0.75 – 1.5 mm ²
Finely stranded connection cross section	0.75 – 1.5 mm ²
Positive opening operation	No
Positive opening contact note	Not suitable for safety circuits!
Number of NOs	2
Actuator	Roller plunger
Clamping range	7 ... 13 mm
Type of connection cable	Finely stranded
Contacts	2 NO
Seal	Silicone
Packaging unit	1
Weight	100 g
Weight	0.22 lb

Mounting / Installation

Connection	Cable entry 8161 1xM20x1.5
------------	----------------------------

Components

Cable glands and entries	1 x M20 Ø 7 ... 13 mm
Material cable gland	Polyamide, Glass fibre reinforced

Technical Drawings – Subject to Alterations

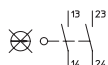

Slow-action contact, 2 NOs
8060/-4; 807./2-4

8060/2-4-R-60 Art. No. 268417

Dimensional Drawings (All Dimensions in mm [inches]) – Subject to Alterations

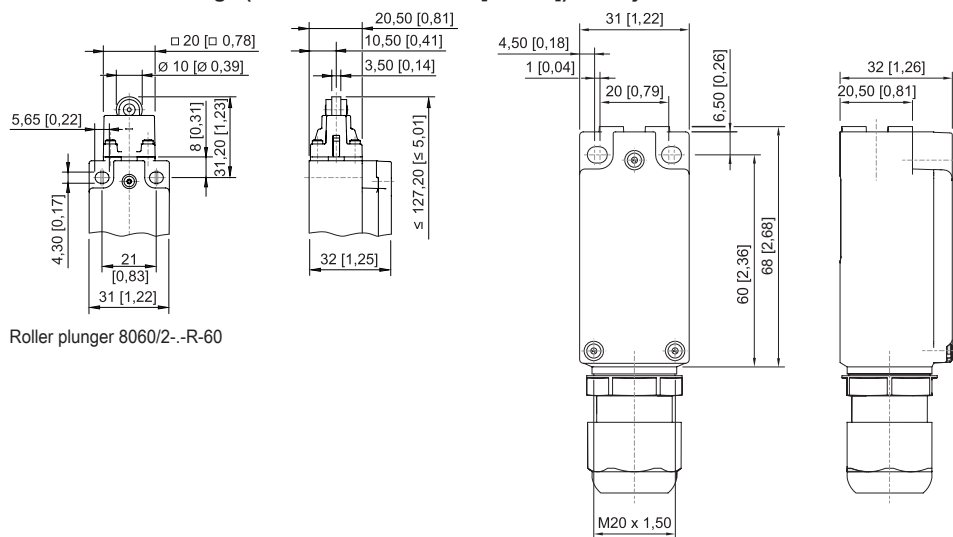

Roller plunger 8060/2-.-R-60

Accessories

Actuator

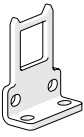
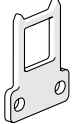
		Art. No.
	Bent actuator, for 8060/2-.-AZ	257053
	Straight actuator, for 8060/2-.-AZ	257052

Plastic cable gland

		Art. No.
	8161/7-M20-1307, Ex e Plastic, M20 x 1.5, cable outer diameter 7 to 13 mm Lot size 50 pieces	239172

Spare Parts

Actuator

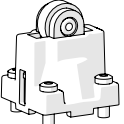
		Art. No.
	Roller plunger actuator	257054

Contact element

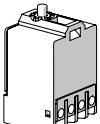
		Art. No.
	2 NO slow-action contact 8080/1-4	132533

Control and signalling devices

Position switch



8060/2-4-R-60 Art. No. 268417

We reserve the right to make alterations to the technical data, dimensions, weights, designs and products available without notice. The illustrations cannot be considered binding.