

Control Devices

Control device for panel mounting

Ex e

8003/111-003 Art. No. 269811



PanSiG



- Flexible configuration due to pushbutton, mushroom push-button, mushroom stay-put button, mushroom stay-put button with key lock, key-operated button, key-operated switch
- Easy assembly thanks to single-hole mounting
- Codable "latching", "spring return", "key not removable" functions
- Spring clamp terminals with connection chamber

MY R. STAHL 8003B



The switches and control buttons for R. STAHL series 8003 panel mounting devices have various switching functions in latching and spring return versions, which can be subsequently recoded, up to 6 A. They are completely certified, explosion-protected equipment with Ex e connection chambers. With the patented mounting mechanism, panel mounting with normal drilled holes of 30.5 mm is quick and easy.

The right actuators are available for a comprehensive range of applications.

Technical Data

Explosion Protection

Scope of validity	European Union (ATEX) IECEX CCC
Application range (zones)	1 2 21 22
IECEX gas certificate	IECEX PTB 06.0065X
IECEX gas explosion protection	Ex db eb IIC T6 Gb
IECEX dust certificate	IECEX PTB 06.0065X
IECEX dust explosion protection	Ex tb IIIC T80 °C Db
ATEX gas certificate	PTB 02 ATEX 1057 X
ATEX gas explosion protection	⊕ II 2 G Ex db eb IIC T6 Gb
ATEX dust certificate	PTB 02 ATEX 1057 X
ATEX dust explosion protection	⊕ II 2 D Ex tb IIIC T80 °C Db
Certificates	ATEX (PTB), IECEX (PTB), Korea (KGS)
Declaration of Conformity	ATEX (EUK), China (CCC), Declaration of Conformity (ATEX)
Notes	Product label may vary. Series devices have certification according to ATEX and IECEX.

Electrical Data

Rated operational voltage AC	500 V
Rated operational current	6 A
Switching capacity AC-12	500 V / 6 A / max. 3000 VA
Switching capacity AC-15	400 V / 6 A / max. 1250 VA
Switching capacity DC-13	110 V / 1 A / max. 110 W
Switching capacity DC-13<SoftReturn/>2 contact elements in series	60 V/6 A

Control Devices

Control device for panel mounting

Ex e

8003/111-003 Art. No. 269811



Ambient Conditions

Ambient temperature	-20 °C ... +60 °C
Ambient temperature	-4 °F ... +140 °F

Mechanical Data

Degree of protection (IP) (IEC 60529)	Reverse side IP65, front side IP66
Enclosure material	Polyamide
Contact material	Silver-nickel
Silicone-free	Yes
Number of NCs	1
Number of NOs	1
Connection cross-section	0.75 ... 1.5 mm ²
Connection cross-section AWG	18 AWG ... 12 AWG
Depth of cut-out	130 mm
Mounting depth, inches	5.12 in
Service life, min.	10 ⁵ operating cycles
Weight	196 g
Weight	0.43 lb

Mounting / Installation

Tightening torque	3 Nm
Tightening torque lbf in	26.55 lbf in

Components

Actuator	Mushroom pushbutton
Entry 1	8161/7-M16-0902
Entry 1 type	Polyamide cable gland, black

Technical Drawings – Subject to Alterations

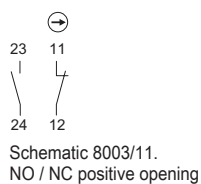

Dimensional Drawings (All Dimensions in mm [inches]) – Subject to Alterations

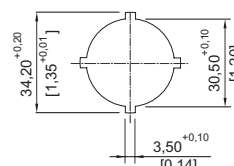
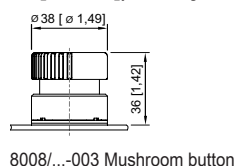
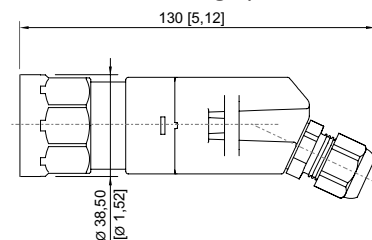

Cut-out details

Control Devices

Control device for panel mounting

Ex e

8003/111-003 Art. No. 269811

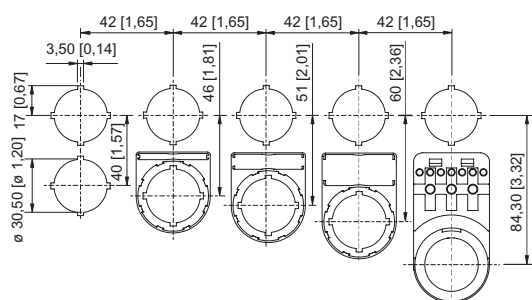

Cut-out with/without additional designation plate

Accessories

Actuator

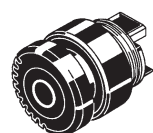

Mushroom pushbuttons Ø 38 mm, black

Art. No.

155526

Spare Parts

Protective collar



8602A0751 metal
for pushbutton/selector switch/mushroom stay-put button with key lock/mushroom stay-put button/mushroom pushbutton dia. 39
BG001, BG003, BG005, BG008, BG009, BG010, BG012

Art. No.

155326

Label mount



Label mount, size 1, without symbol label
Text: 1 line
for actuators to fit Ø 30.5 mm holes

Art. No.

155632



Label mount, size 2, without symbol label
Text: 1 or 2 lines
for actuators to fit Ø 30.5 mm holes

Art. No.

155687



Label mount, size 3, without symbol label
Text: 1, 2 or 3 lines
for actuators to fit Ø 30.5 mm holes

Art. No.

155844

Symbol label for pushbutton and selector switch



Colour: blue
Please specify text or symbol

Art. No.

155910



Colour: green
Please specify text or symbol

Art. No.

155900

Control Devices

Control device for panel mounting

Ex e

8003/111-003 Art. No. 269811

STAHL

	Colour: white Text: START	155889
	Colour: blue Text: RESET	155894
	Colour: green Text: START	155721
	Colour: black Text: Ab	155886
	Colour: black Text: Auf	155883
	Colour: black Symbol: Arrow	155749
	Colour: black Symbol: Arrow	155761
	Colour: black Text: Links	155827
	Colour: black Text: Rechts	155837
	Colour: black Text: Open	155868
	Colour: black Text: CLOSE	155878
	Colour: black Text: Zu	155874



Control Devices

Control device for panel mounting

Ex e

8003/111-003 Art. No. 269811



	Colour: red Text: OFF	155654
	Colour: green Text: ON	155671

Insert discs for label holder **Art. No.**

	One-line Plain Material: PVC Colour: White Self-adhesive	238271
--	--	--------

Symbol label for pushbutton and selector switch **Art. No.**

	Colour: red Text: AUS	155634
---	--------------------------	--------

Insert discs for label holder **Art. No.**

	Two-line Plain Material: PVC Colour: White Self-adhesive	238272
--	--	--------



Symbol label for pushbutton and selector switch **Art. No.**

	Colour: black Text: AUS	155806
--	----------------------------	--------

Insert discs for label holder **Art. No.**

	Three-line Plain Material: PVC Colour: White Self-adhesive	238273
--	--	--------

Symbol label for pushbutton and selector switch **Art. No.**

	Colour: black Text: EIN	155862
	Colour: red Text: STOP	155615

Control Devices

Control device for panel mounting

Ex e

8003/111-003 Art. No. 269811



	Colour: black Text: STOP	155795
--	-----------------------------	--------

Closing part

		Art. No.
	8602C3-733-B for closing unused holes in cover, dia. 30.5 mm, NBR	244306
	8602C3-733-S for closing unused holes in cover, dia. 30.5 mm, silicone	244307

Symbol label for pushbutton and selector switch

		Art. No.
	Colour: black Text: I	155846
	Colour: green Text: I	155689
	Colour: white Text: I	155892
	Colour: black Text: II	155854
	Colour: green Text: II	155706
	Colour: red Text: O	155596
	Colour: black Text: O	155783
	Colour: black Text: I O	155771
	Colour: blue Blank label without text	155911





Control Devices

Control device for panel mounting

Ex e

8003/111-003 Art. No. 269811



	Colour: yellow Blank label without text	155914
	Colour: red Blank label without text	155897
	Colour: green Blank label without text	155901
	Colour: white Blank label without text	155908
	Colour: black Blank label without text	155905

We reserve the right to make alterations to the technical data, dimensions, weights, designs and products available without notice. The illustrations cannot be considered binding.