

Control and signalling devices

Control devices for panel mounting

Ex e

8003/121-001S Art. No. 269832



PanSiG



- Flexible configuration thanks to pushbutton, mushroom push-button, mushroom stay-put button, mushroom stay-put button with key lock, key-operated button and key-operated switch
- Easy to install using a single hole
- Codable "latching", "spring return" and "key not removable" functions
- Spring clamp terminals with connection chamber

MY R. STAHL 8003B



R. STAHL Series 8003 switches and control buttons for panel mounting take on various switching functions in latching and spring return positions up to 6 A, which can be subsequently recoded. They are fully certified, explosion-protected equipment with an Ex e connection chamber. With the patented mounting mechanism, panel mounting with drilled holes or openings of 30.5 mm is quick and easy.

Compatible actuators are available for a comprehensive range of applications.

Technical Data

Explosion Protection

| | |
|---------------------------------|--|
| Area of application | European Union (ATEX) IECEX CCC |
| Application range (zones) | 1, 2, 21, 22 |
| IECEX gas certificate | IECEX PTB 06.0065X |
| IECEX gas explosion protection | Ex db eb IIC T6 Gb |
| IECEX dust certificate | IECEX PTB 06.0065X |
| IECEX dust explosion protection | Ex tb IIIC T80 °C Db |
| ATEX gas certificate | PTB 02 ATEX 1057 X |
| ATEX gas explosion protection | ⊕ II 2 G Ex db eb IIC T6 Gb |
| ATEX dust certificate | PTB 02 ATEX 1057 X |
| ATEX dust explosion protection | ⊕ II 2 D Ex tb IIIC T80 °C Db |
| Certificates | ATEX (PTB), China (CQST), IECEX (PTB), Korea (KGS) |
| Declaration of conformity | ATEX (EUK), China (CCC), Declaration of Conformity (ATEX) |
| Notes | Product label may vary. Series devices are labelled with ATEX and IECEX. |

Electrical Data

| | |
|---|----------------------------|
| Rated operational voltage AC | 500 V |
| Rated operational current | 6 A |
| Switching capacity AC-12 | 500 V / 6 A / max. 3000 VA |
| Switching capacity AC-15 | 400 V / 6 A / max. 1250 VA |
| Switching capacity DC-13 | 110 V / 1 A / max. 110 W |
| Switching capacity DC-13<SoftReturn/>2 contact elements in series | 60 V/6 A |

Ambient Conditions

| | |
|---------------------|--------------------|
| Ambient temperature | -55 °C ... 60 °C |
| Ambient temperature | -67 °F ... +140 °F |

Control and signalling devices

Control devices for panel mounting



Ex e

8003/121-001S Art. No. 269832

Mechanical Data

| | |
|---------------------------------------|------------------------------------|
| Degree of protection (IP) (IEC 60529) | Reverse side IP65, front side IP66 |
| Enclosure material | Polyamide |
| Contact material | Silver-nickel |
| Silicone-free | No |
| Number of NCs | 2 |
| Connection cross-section | 0.75 ... 1.5 mm ² |
| Connection cross-section AWG | 18 AWG ... 12 AWG |
| Depth of cut-out | 130 mm |
| Mounting depth in inches | 5.12 in |
| Service life, min. | 10 ⁵ operating cycles |
| Weight | 140 g |
| Weight | 0.31 lb |

Mounting / Installation

| | |
|--------------------------|--------------|
| Tightening torque | 3 N · m |
| Tightening torque lbf in | 26.55 lbf in |

Components

| | |
|--------------|------------------------------|
| Actuator | Pushbutton |
| Entry 1 | 8161/7-M16-0902 |
| Entry 1 type | Polyamide cable gland, black |

Technical Drawings – Subject to Alterations

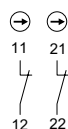

Schematic 8003/12.
Positive opening NC

Dimensional Drawings (All Dimensions in mm [inches]) – Subject to Alterations

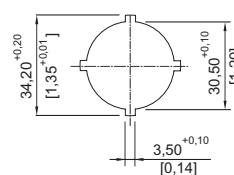
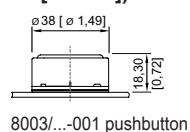
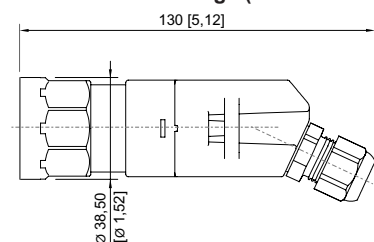

Punch pattern

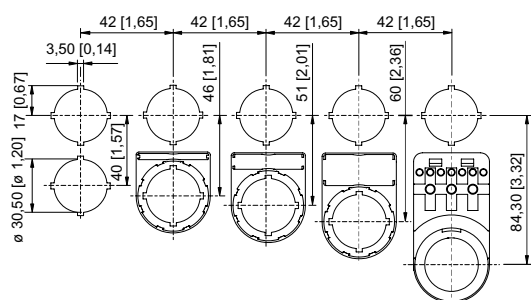

Cut-out with/without additional designation plate

Control and signalling devices





Control devices for panel mounting

Ex e





8003/121-001S Art. No. 269832



Accessories

| Actuators | | Art. No. |
|---|---|----------|
|  | Pushbutton | 155525 |
| Locking devices | | Art. No. |
|  | 8602A0754 for actuated pushbutton/selector switch BG001, BG005 | 155402 |
|  | 8602A0755 for not actuated pushbutton/selector switch BG001, BG005 | 155431 |
| Closing part | | Art. No. |
|  | 8602C3-733-B for closing unused holes in cover, dia. 30.5 mm, NBR | 244306 |
| | 8602C3-733-S for closing unused holes in cover, dia. 30.5 mm, silicone | 244307 |

Spare Parts

| Label holder | | Art. No. |
|--|--|----------|
|  | Label holder, size 1, without insert disc Labelling: 1-line can be installed in dia. 30.5 mm drilled holes for actuators | 155632 |
|  | Label holder, size 2, without insert disc Labelling: 1- or 2-line can be installed in dia. 30.5 mm drilled holes for actuators | 155687 |
| Locking devices | | Art. No. |
|  | 8602A0753 H24 for not actuated pushbutton/selector switch BG001, BG005 | 155372 |
| Label holder | | Art. No. |
|  | Label holder, size 3, without insert disc Labelling: 1-, 2- or 3-line can be installed in dia. 30.5 mm drilled holes for actuators | 155844 |

Control and signalling devices

Control devices for panel mounting







Ex e

8003/121-001S Art. No. 269832

Designation plates for pushbuttons and selector switches

Art. No.

| | | |
|---|------------------------------|--------|
|  | Colour: White Text: START | 155889 |
|  | Colour: Blue Text: RESET | 155894 |
|  | Colour: Green Text: START | 155721 |
|  | Colour: Black Text: Ab | 155886 |
|  | Colour: Black Text: Auf | 155883 |





Protective collar

Art. No.

| | | |
|--|--|--------|
|  | 8602A0751 metal for pushbutton/selector switch/mushroom stay-put button with key lock/mushroom stay-put button/mushroom pushbutton dia. 39 BG001, BG003, BG005, BG008, BG009, BG010, BG012 | 155326 |
|--|--|--------|

Designation plates for pushbuttons and selector switches

Art. No.

| | | |
|--|--------------------------------|--------|
|  | Colour: Black Symbol: Arrow | 155749 |
|  | Colour: Black Symbol: Arrow | 155761 |
|  | Colour: Black Text: Links | 155827 |
|  | Colour: Black Text: Rechts | 155837 |
|  | Colour: Black Text: Open | 155868 |

Control and signalling devices

Control devices for panel mounting



Ex e

8003/121-001S Art. No. 269832

| | | |
|---|------------------------------|--------|
|  | Colour: Black Text: CLOSE | 155878 |
|  | Colour: Black Text: Zu | 155874 |
|  | Colour: Red Text: OFF | 155654 |
|  | Colour: Green Text: ON | 155671 |
|  | Colour: Red Text: AUS | 155634 |

Insert discs for label holder

Art. No.

| | | |
|--|--|--------|
|  | One-line Plain Material: PVC Colour: White Self-adhesive | 238271 |
|--|--|--------|

Designation plates for pushbuttons and selector switches

Art. No.

| | | |
|--|----------------------------|--------|
|  | Colour: Black Text: AUS | 155806 |
|--|----------------------------|--------|

Insert discs for label holder

Art. No.

| | | |
|--|--|--------|
|  | Two-line Plain Material: PVC Colour: White Self-adhesive | 238272 |
|--|--|--------|

Designation plates for pushbuttons and selector switches

Art. No.

| | | |
|--|----------------------------|--------|
|  | Colour: Black Text: EIN | 155862 |
|--|----------------------------|--------|

Insert discs for label holder

Art. No.

| | | |
|--|--|--------|
|  | Three-line Plain Material: PVC Colour: White Self-adhesive | 238273 |
|--|--|--------|

Control and signalling devices

Control devices for panel mounting





Ex e

8003/121-001S Art. No. 269832

Designation plates for pushbuttons and selector switches

Art. No.

| | | |
|--|---|--------|
|  | Colour: Black Text: STOP | 155795 |
|  | Colour: Black Text: I | 155846 |
|  | Colour: Green Text: I | 155689 |
|  | Colour: White Text: I | 155892 |
|  | Colour: Black Text: II | 155854 |
|  | Colour: Green Text: II | 155706 |
|  | Colour: Red Text: O | 155596 |
|  | Colour: Black Text: O | 155783 |
|  | Colour: Black Text: I O | 155771 |
|  | Colour: Blue Blank disc without text | 155911 |
|  | Colour: Yellow Blank disc without text | 155914 |





Control and signalling devices

Control devices for panel mounting



Ex e

8003/121-001S Art. No. 269832

| | | |
|--|--|--------|
|  | Colour: Red Blank disc without text | 155897 |
|  | Colour: Green Blank disc without text | 155901 |
|  | Colour: White Blank disc without text | 155908 |
|  | Colour: Black Blank disc without text | 155905 |

We reserve the right to make alterations to the technical data, dimensions, weights, designs and products available without notice. The illustrations cannot be considered binding.