

Installation equipment

Mushroom stay-put button With key

EM-STOP

8602C3-009-S .. MS2 Art. No. 270415



- Pushbutton, mushroom pushbutton, mushroom stay-put button with key lock, mushroom stay-put button, twin pushbutton and illuminated pushbutton, rotary actuator, key-operated switch, potentiometer bezel and indicator lamp bezel
- One axial actuator can actuate up to four Series 8082 contact elements
- Key-operated switches and rotary switches codable at any time as "latching/spring return" or "key not removable"

MY R. STAHL 8602A



Thanks to their special technical features, the actuators from the 8602/3 series can withstand the most extreme conditions. In addition to the application option for use in ambient temperatures from -60 °C to +70 °C, the IP degree of protection, IP66, is maintained in accordance with EN 60529. It is also possible to actuate up to four contact elements from the 8082 series with a single axial actuator from the 8602/3 series.

The coding option of the key switches and rotary switches is innovative and one-of-a-kind. Integrated coding allows you to adjust the "latching/spring return" and/or "key not removable" functions at any time without additional accessories. A versatile set of accessories consisting of label holders and locking devices is available.

Technical Data

Explosion Protection

| | |
|---------------------------------|--|
| Application range (zones) | 1 2 21 22 |
| IECEX gas certificate | IECEX PTB 13.0047U |
| IECEX gas explosion protection | Ex eb IIC Gb |
| IECEX dust certificate | IECEX PTB 13.0047 U |
| IECEX dust explosion protection | Ex tb IIIC Db |
| ATEX gas certificate | PTB 13 ATEX 1019 U |
| ATEX gas explosion protection | Ex II 2 G Ex eb IIC Gb |
| ATEX dust certificate | PTB 13 ATEX 1019 U |
| ATEX dust explosion protection | Ex II 2 D Ex tb IIIC Db |
| UL gas certificate | E182378 V4 S2 |
| Inmetro gas certificate | UL-BR 14.0380U |
| Inmetro dust certificate | UL-BR 14.0380U |
| Certificates | ATEX (PTB), Brazil (ULB), Canada / USA (UL), Canada (UL), IECEX (PTB), India (PESO), Korea (KGS) |

Functional Safety

| | |
|-------------|--|
| SIL-capable | Only with contact elements 8082/1, 8082/2 and 8208/24-15 |
|-------------|--|

Ambient Conditions

| | |
|---------------------|--------------------|
| Ambient temperature | -60 °C ... +70 °C |
| Ambient temperature | -76 °F ... +158 °F |
| Storage temperature | -60 °C ... +70 °C |

Installation equipment

Mushroom stay-put button With key

EM-STOP

8602C3-009-S .. MS2 Art. No. 270415



Ambient Conditions

| | |
|-------------------------|--------------------|
| Storage temperature | -76 °F ... +158 °F |
| Use at the height of | < 2000 m |
| Degree of contamination | 3 |

Mechanical Data

| | |
|------------------------------|----------------------------|
| Version | with key lock |
| Degree of protection (IP) | IP66 |
| Note on degree of protection | According to IEC/EN 60529 |
| Enclosure material | Polyamide |
| Silicone-free | No |
| Assembly | 009 |
| Diameter | 39 mm |
| Service life, min. | 10 ⁵ actuations |
| Impact strength (IEC 60079) | 7 J |
| Impact strength (IEC 62262) | min. IK08 |
| Colour | Yellow/red |
| Fastening | Thread type |
| Designation plate | With yellow backing plate |
| Seal | Silicone |
| Closing | MS2 |
| Packaging unit | 1 |
| Weight | 75 g |
| Weight | 0.17 lb |
| Description note | Two keys enclosed. |

Mounting / Installation

| | |
|--------------------------|--------------|
| Tightening torque | 3 Nm |
| Tightening torque lbf in | 26.55 lbf in |

Technical Drawings – Subject to Alterations

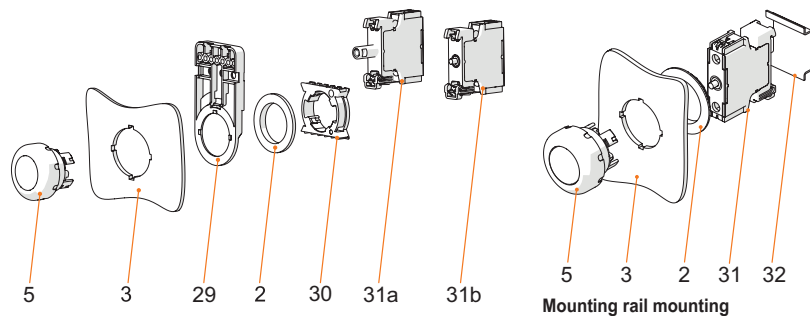

Front installation mounting with Series 8010/6 indicator lamp and Series 8082/3 contact element

Mounting rail mounting

Key

- 2 = jam nut (order no. 205592)
- 3 = installation wall (wall thickness max. 5 mm [0.197 inch])
- 5 = actuator with seal
- 29 = support for cable duct (optional) (order no. 248673)
- 30 = adaptor (order no. 227038)
- 31a = built-in element: LED element 8010/6
- 31b = built-in element: Contact element 8082/3

- 2 = jam nut (order no. 205592)
- 3 = installation wall (wall thickness max. 5 mm [0.197 inch])
- 5 = actuator with seal
- 31 = built-in element
- 32 = TS35 mounting rail

Installation equipment

Mushroom stay-put button With key

EM-STOP

8602C3-009-S .. MS2 Art. No. 270415



Dimensional Drawings (All Dimensions in mm [inches]) – Subject to Alterations

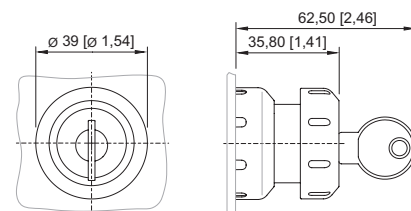
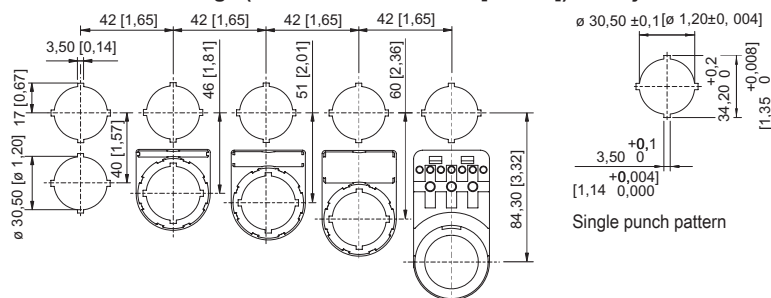

8602/3-006 red/black mushroom stay-put button with key lock
 8602/3-009 red/yellow mushroom stay-put button with key lock
 Actuator with axial actuation

Cut-out with/without additional designation plate

Accessories

Spare key





Closing MS2

Art. No.

272645

Spare Parts

Insert discs for label holder

| | | Art. No. |
|--|--|----------|
|  | One-line Plain Material: PVC Colour: White Self-adhesive | 238271 |
|  | Two-line Plain Material: PVC Colour: White Self-adhesive | 238272 |
|  | Three-line Plain Material: PVC Colour: White Self-adhesive | 238273 |

Label, yellow, general



for Ø 39 actuator (EM-STOP)

Art. No.

223571

Closing part



8602C3-733-B
for closing unused holes in cover, dia. 30.5 mm, NBR

8602C3-733-S
for closing unused holes in cover, dia. 30.5 mm, silicone

Art. No.

244306

244307









Installation equipment

Mushroom stay-put button With key

EM-STOP

8602C3-009-S .. MS2 Art. No. 270415

STAHL

| Protective collar | | Art. No. |
|--|---|----------|
|  | 8602C3-751 plastic/red for mushroom stay-put button with key lock/mushroom stay-put button dia. 39 BG006, BG009, BG010, BG012 | 257707 |
|  | 8602C3-751 plastic/yellow for mushroom stay-put button with key lock/mushroom stay-put button dia. 39 BG006, BG009, BG010, BG012 | 257708 |
| Label holder | | Art. No. |
|  | Size 1, without insert disc, 1-line label for actuators Ø 39 | 223566 |
|  | Size 2, without insert disc, 1- or 2-line label for actuators Ø 39 | 223567 |
|  | Size 3, without insert disc, 1-, 2- or 3-line label for actuators Ø 39 | 223568 |
| Special key | | Art. No. |
|  | for tightening plastic locking nut | 169101 |
| Pressure plates | | Art. No. |
|  | Dia. 37 mm Three contact elements | 215436 |
|  | Dia. 48.5 mm Four contact elements | 215437 |
| Holder for front installation | | Art. No. |
|  | 8602/3 holder for cable duct | 248673 |

Installation equipment

Mushroom stay-put button With key

EM-STOP

8602C3-009-S .. MS2 Art. No. 270415



Adaptor for front installation

Art. No.



8602/3 Front installation for indicator lamp series 8010/6 and contact element series 8082/3

227038

8082/3 Contact element

Art. No.



For NC front installation

240898

for NO contact front installation

240899

We reserve the right to make alterations to the technical data, dimensions, weights, designs and products available without notice. The illustrations cannot be considered binding.