

6050/606-600-6B2-108850-000 Art. No. 272696



- Extremely compact universal light fitting with 4 power classes
- Can be used as a ceiling light fitting, pendant light fitting or floodlight
- Three light distribution curves available: Ultra-wide-beam, wide-beam and medium-wide-beam
- Glare-free thanks to opaque light fitting covering
- Quick, easy installation thanks to Ex e connection chamber
- Universally suitable for use in particularly cold environments as cold as -55 °C
- Suitable for particularly high ambient temperatures up to +70 °C

MY R. STAHL 6050C



The 6050/6 universal spotlight is equipment used for lighting areas, work equipment and objects. It can be used indoors and outdoors. The clear lens is available in a matted version to limit the glare. Using an internal reflector, the universal spotlight can be adapted as a narrow beam, wide beam or a medium-wide beam to suit the lighting task.

### Technical Data

Explosion Protection	
Application range (zones)	1, 2, 21, 22
IECEX gas certificate	IECEX EPS 17.0093
IECEX gas explosion protection	Ex db eb op is IIC T6 Gb
IECEX dust certificate	IECEX EPS 17.0093
IECEX dust explosion protection	Ex tb op is IIIC T80 °C Db
ATEX gas certificate	EPS 17 ATEX 1 181
ATEX gas explosion protection	Ex II 2 G Ex db eb op is IIC T6 Gb
ATEX dust certificate	EPS 17 ATEX 1 181
ATEX dust explosion protection	Ex II 2 D Ex tb op is IIIC T80 °C Db
Certificates and approvals	ATEX IECEX UKEX
Certificates	ATEX (BVIS), Brazil (ULB), IECEX (BVIS), Polen (CNBOP)
Ship approval	DNVGL
Declaration of conformity	ATEX (EUK), Declaration of Conformity (AUS)
Electrical Data	
Rated operational voltage AC	110 ... 277 V
Frequency range	50 – 60 Hz
Start-up current	I <sub>peak</sub> = 55 A, Delta t = 230 µs
Lighting Data	
Number of lamps	1
Lamp wattage	60 W
Lamp type	LED
Lamp	LED
Light colour	5000 K – neutral white
Light distribution	Medium-beam
Luminaire efficacy	122 lm/W

6050/606-600-6B2-108850-000 Art. No. 272696

### Lighting Data

Luminous flux	7400 lm
Colour rendering	≥ 80
Colour temperature	5000 K

### Ambient Conditions

Ambient temperature	-40 °C ... +50 °C
---------------------	-------------------

### Mechanical Data

Version	Ceiling mounting
Degree of protection (IP)	IP66 / IP68 (10 m)
IP degree of protection (IEC 60598)	IP66/IP68
Enclosure material	Aluminium, Seawater-resistant
Enclosure colour	Standard
Sealing material	Silicone
Silicone-free content	Contains silicone
Protective glass material 2	Pressed glass
Max. solid connection terminals	6 mm <sup>2</sup>
Max. finely stranded connection terminals	4 mm <sup>2</sup>
Type of connection cable	Finely stranded Solid Finely stranded with clip
Size	1
Width	260 mm
Height	210 mm
Length	310 mm
Reflector	Yes
Weight	7.04 kg
Weight	15.52 lb
Disconnection of the luminaire	No

### Components

Cable glands and entries	1 x M25 x 1.5
Stopping plugs	1 x M25 x 1.5
Wire guard	Yes

### Technical Drawings – Subject to Alterations

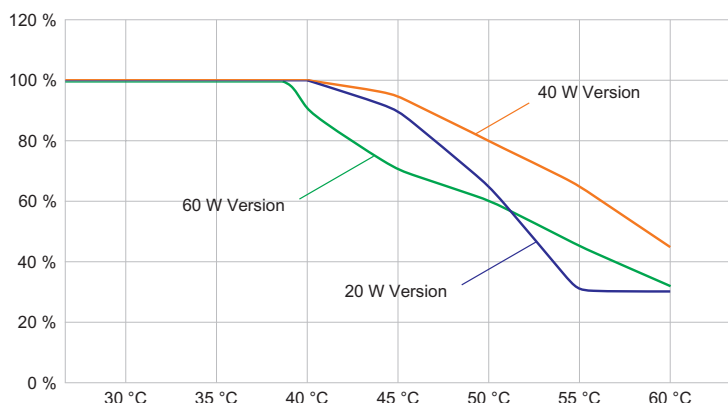

Luminous flux decrease at ambient temperature - variants with DALI

6050/606-600-6B2-108850-000 Art. No. 272696



Luminous flux decrease at ambient temperature - variants without DALI

### Light Distribution Curves

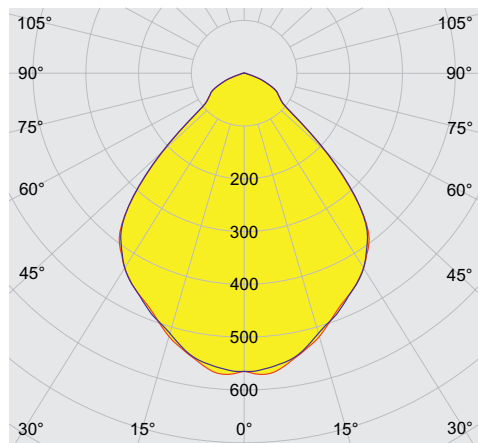

cd/klm  $\eta = 100\%$   
 — C0 - C180 — C90 - C270

With internal reflector, protection glass clear

### Dimensional Drawings (All Dimensions in mm [inches]) – Subject to Alterations

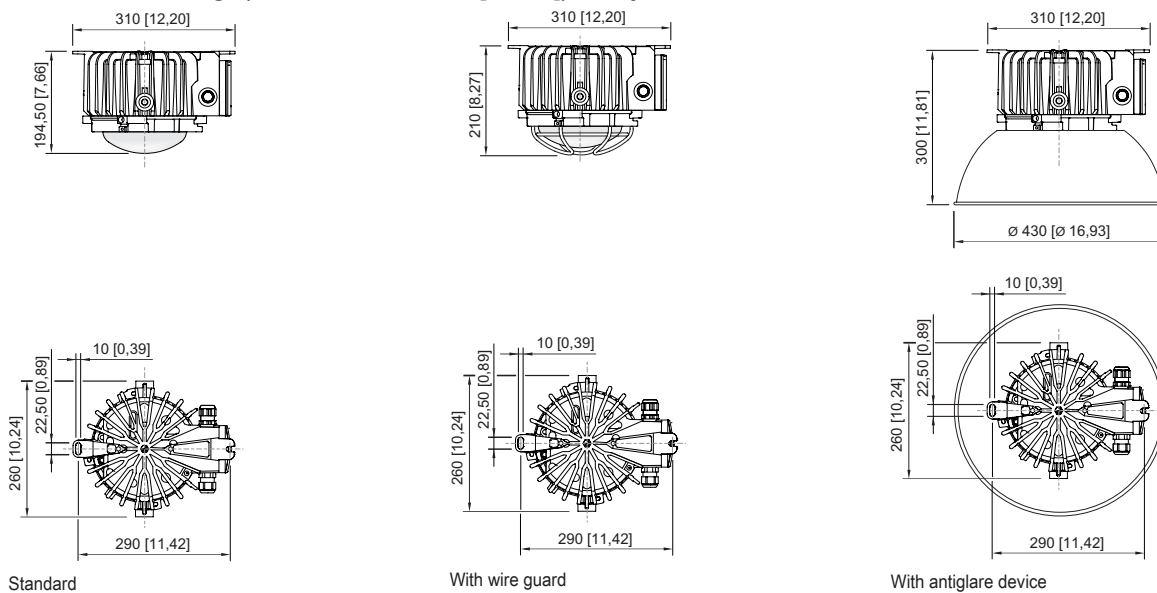

### Accessories

# Lighting

## LED pendant light fitting



6050/606-600-6B2-108850-000 Art. No. 272696

### Antiglare device / reflector

Art. No.

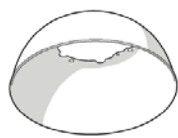

Complete with mounting parts  
Material: Aluminium  
For 6050/11 and 6050/6

118565

### External reflector

Art. No.

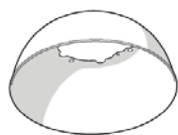

Narrow-beam  
Complete with mounting parts  
Material: High-gloss anodised aluminium  
For 6050/11

118558

### Mounting bracket

Art. No.



Complete; made from stainless steel (for subsequent self-mounting)  
For 6050/6

265877

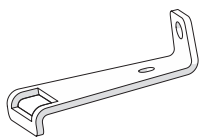

The stainless steel mounting fixture is fastened to the enclosure of the pendant light fitting series 6050/6 by means of two stainless steel screws M8.

269716

### Pipe clamp

Art. No.

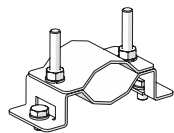

for pipe R 1 1/4" to 2"

268967

### Plastic cable gland

Art. No.



8161/7-M25-1707  
7 to 17 mm<sup>2</sup>  
1 piece

229918

8161/7-M25-1707, Ex e  
Plastic, M25 x 1.5, cable outer diameter 7 to 17 mm  
Lot size 50 pieces

239157

### Ring bolt

Art. No.



M8, für 6050/6, direct mounting; 1 pair  
M10, direct mounting in insert nuts; 1 pair

265874

118560

### Stopping plug

Art. No.



8290/3-M25  
Plastic, M25 x 1.5  
Lot size 1 piece

143524

# Lighting

## LED pendant light fitting



6050/606-600-6B2-108850-000 Art. No. 272696

### Wire guard

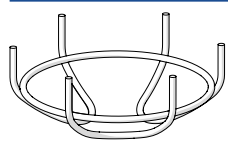

Complete with mounting parts  
Material: Stainless steel wire  
For 6050/6

### Art. No.

221774

We reserve the right to make alterations to the technical data, dimensions, weights, designs and products available without notice. The illustrations cannot be considered binding.