



- Reliable, load-rated disconnect switch with easily visible, lockable handle and switching position display
- An integrated auxiliary contact for control and signaling purposes, can optionally be enhanced with pluggable, easily retrofittable Ex e or Ex i auxiliary contacts
- Wide temperature range
- High mechanical impact and shock resistance
- Perfect protection against the ingress of liquids and dust
- 3D data available to download from the website

D

## MY R. STAHL 8579F



R. STAHL Series 8579/41 receptacles for Class I, Div. 2, Groups A, B, C, D and Zone 1/21 in a 4- and 5-pole version have full AC-3 switching capacity up to 60 A. The high degree of protection IP66 guarantees the highest level of protection against the penetration of dust and water in any application position. Self-cleaning lamellar contacts provide optimum contact and the plugs can be inserted and removed in the zero position quickly and easily. The load disconnect switch, with mechanical locking device and a handle that can be locked in the ON (0) or OFF (I) position, is an additional safety feature.

	NEC® 500 CE Code Appendix J					
	Class I		Class II		Class III	
Division	1	2	1	2	1	2
Ex interface						
Installation in		•	•	•	•	•

	CE Code Section 18					
	NEC® 505			NEC® 506		
	Class I					
Zone	0	1	2	20	21	22
Ex interface						
Installation in		•	•			

	IECEx / ATEX					
	0	1	2	20	21	22
Zone						
Ex interface						
Installation in		•	•		•	•

Selection Table								
Product description		Wall-mounting receptacle 60 A						
Auxiliary contacts		2 (1 NO + 1 NC)						
Figure	Detailed number of poles	Coding (clock hour position)	Rated operational voltage	Color code	Frequency range	Product Type	Art. No.	Weight lb
	3-pole, 4 wire	5	600 V AC	Black	50 / 60 Hz	8579/41-405	202087	17.2 lb
		7	480 V AC	Red	50 / 60 Hz	8579/41-407	202088	17.2 lb
		9	250 V AC	Blue	50 / 60 Hz	8579/41-409	202089	17.2 lb
	4-pole, 5 wire	7	480Y/277 V AC	Red	50 / 60 Hz	8579/41-507	202085	17.2 lb
		9	208Y/120 V AC	Blue	50 / 60 Hz	8579/41-509	202086	17.2 lb

Technical Data	
Explosion Protection	
Area of application	European Union (ATEX) Canada IECEx USA
Area of application Note	Other country markings available on request
FMus certificate	OR6A2.AX
cFM certificate	3050350

Technical Data	
<b>Explosion Protection</b>	
Marking FMus	Class I, Div. 2, Groups A,B,C,D; Class II, III, Div. 1, Groups E,F,G, Enclosure Type 3, 4, 4X Class I, Zone 1, AEx d e IIC T6 Gb;
Marking cFM	Class I, Zone 1, Ex d e IIC T6 Gb; Cl. I, Div. 2 per CEC J18-150, Class II, Div. 1, Groups G, Enclosure Type 3, 4, 4X
IECEX gas explosion protection	Ex db eb IIC T6 ... T5 Gb
IECEX dust explosion protection	Ex tb IIIC T60 °C / T75 °C Db
ATEX gas explosion protection	⊕ II 2 G Ex db eb IIC T6 ... T5 Gb
ATEX dust explosion protection	⊕ II 2 D Ex tb IIIC T60 °C / T75 °C Db
Certificates	ATEX (PTB), Brazil (ULB), Canada (FM), China (CQST), IECEX (PTB), Korea (KGS), USA (FM)
<b>Electrical Data</b>	
Rated operational current	max. 60 A
Switching capacity main contacts	3-phase 600 V AC, 60 hp 480 V AC, 40 hp 250 V AC, 20 hp
<b>Device Specific Data</b>	
Back-up fuse with thermal protection	80 A gG
Back-up fuse without thermal protection	63 A gG
<b>Ambient Conditions</b>	
Ambient temperature °F	-22 °F ... +104 °F (T6) -22 °F ... +131 °F (T5)
Ambient temperature °C	-30 °C ... +40 °C (T6) -30 °C ... +55 °C (T5)
Notes	For further information, see the operating instructions.
<b>Mechanical Data</b>	
Enclosure type (NEMA250)	3, 4, 4X
IP degree of protection (IEC 60529)	IP66
IP degree of protection (IEC 60079)	IP66
Enclosure material	Polyester, Glass fiber reinforced
Silicone-free	No
Multiple conductor connection AWG	2 x AWG 6
Multiple conductor connection	2 x 16 mm <sup>2</sup>
Finely stranded connection cross-section AWG	1 x AWG 6 ... 1 x AWG 1/0
Finely stranded connection cross-section	1 x 16 mm <sup>2</sup> ... 1 x 50 mm <sup>2</sup>
Stranded connection cross-section AWG	1 x AWG 6 ... 1 x AWG 1/0
Stranded connection cross-section	1 x 16 mm <sup>2</sup> ... 1 x 50 mm <sup>2</sup>
Impact strength (IEC 60079)	7 J
Impact strength (IEC 62262)	IK10
Lockable in	in 0- and I-position
<b>Components</b>	
Cable entry note	Entry 1: Bottom left Entry 2: Bottom right
Entry 1 model	can be ordered as an accessory
Entry 1	NPT 1 1/2"
Metal entry possible 1	Yes
Entry 2 model	8290/3-M25
Entry 2 type	Polyamide stopping plug
Entry 2	M25 x 1.5
Metal entry possible 2	No
Notes	Cable gland position: Bottom (standard); optionally also on the top or side

## Arrangement of the Ground Contact Sleeves

Time position  
Example: 6h position

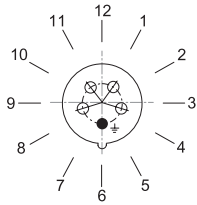

## Arrangement of receptacle contacts and terminal markings

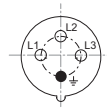

3 P + PE

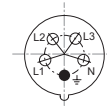

3 P + N + PE

Arrangement of the receptacle contacts and terminal markings in the 6h position  
(view from the front side of the receptacle to the receptacle contacts)

## Accessories

Figure	Description	Product Type	Art. No.	Weight lb
<b>Auxiliary contact</b>				
	2 NC (8080/1-3) 250 V AC/DC Max. 6 A 1.5 to 2.5 mm <sup>2</sup> , solid/finely stranded The switching function of the auxiliary contact depends on the installation slot used. Left and right: Synchronising	8544C0302-1-6 aux. contact 2NC	168356	0.06
	1 NC + 1 NO (8080/1-1) 250 V AC/DC Max. 6 A 1.5 to 2.5 mm <sup>2</sup> , solid/finely stranded The switching function of the auxiliary contact depends on the installation slot used. Left: Delayed (ON), leading (OFF) Right: Synchronising	8544C0302-2-6 aux. contact 1NO 1 NC	168351	0.06
	2 NO (8080/1-4) 250 V AC/DC Max. 6 A 1.5 to 2.5 mm <sup>2</sup> , solid/finely stranded The switching function of the auxiliary contact depends on the installation slot used. Left and right: Synchronising	8544C0302-3-6 aux. contact 2NO	168353	0.06

## Spare Parts

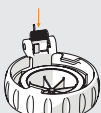
Figure	Description	Product Type	Art. No.	Weight lb
<b>Auxiliary contact key</b>				
	For removing installed auxiliary contacts	Aux. Contact Key 8544	201909	0.08
<b>Repair set for receptacles series 8579</b>				
	Repair set 8579 hinged cover, black	Repair kit 8579 hinged cover BK	275509	0.41
	Repair set 8579 hinged cover, blue	Repair kit 8579 hinged cover BU	275507	0.41
	Repair set 8579 hinged cover, red	Repair kit 8579 hinged cover RD	275508	0.41

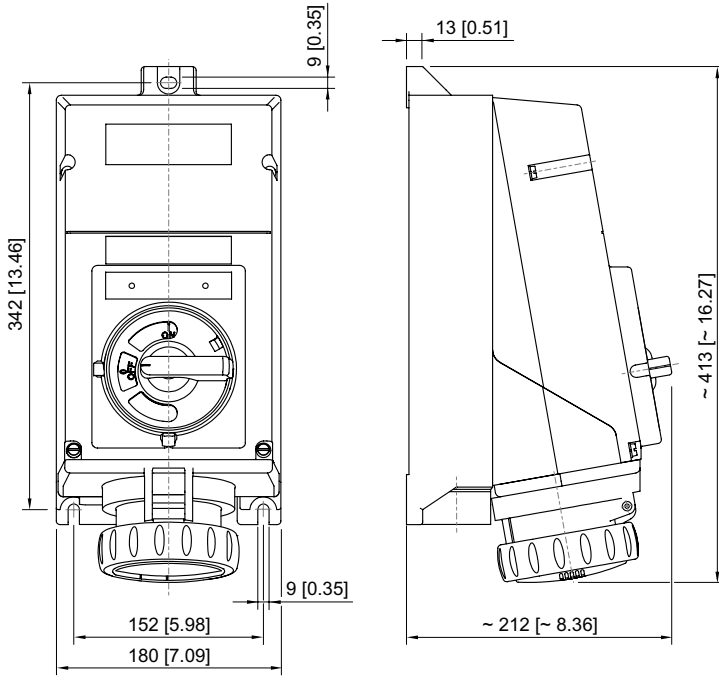

Wall-mounting receptacle