

Isolator Barriers

Resistance isolator

Ex i field circuit ISpac

9180/21-77-11s Art. No. 160502



- Ex i resistance isolator 9180/.0 for Pt100 or 9180/.1 for Pt1000
- World's only two-channel device requiring just 8.8 mm of space per channel
- For two-, three- and four-conductor connection

MY R. STAHL 9180A



9180 series Ex i resistance isolators can be used for the intrinsically safe operation of Pt100 (9180/.0) or Pt1000 (9180/.1) resistance temperature detectors. The resistance measured at the input is transmitted to the output and can thereby be measured by an I/O card. The auxiliary power, output and intrinsically safe input are galvanically separated.

Technical Data

Explosion Protection	
Application range (Zones)	2
Ex interface zone	0 1 2 20 21 22
IECEX gas certificate	IECEX BVS 10.0055 X
IECEX gas explosion protection	Ex ec nC [ia Ga] IIC T4 Gc
IECEX dust certificate	IECEX BVS 10.0055 X
IECEX dust explosion protection	[Ex ia Da] IIIC
ATEX gas certificate	BVS 05 ATEX E 176 X
ATEX gas explosion protection	⊕ II 3 (1) G Ex ec nC [ia Ga] IIC T4 Gc
ATEX dust certificate	BVS 05 ATEX E 176 X
ATEX dust explosion protection	⊕ II (1) D [Ex ia Da] IIIC
FMus certificate	FM16US0122X
cFM certificate	FM16CA0067X
Marking cFMus	Class I, Div. 2, Groups A,B,C,D; Class I, Zone 2, AEx/Ex nA nC Group IIC AIS Class I,II,III, Div. 1, Groups A,B,C,D,E,F,G; Class I, Zone 0, [AEx ia]/[Ex ia] IIC T4 at Ta = 70°C See Doc. 9180 6 031 001 1
Certificates	ATEX (BVS), Brazil (ULB), Canada (FM), China (NEPSI), IECEX (BVS), India (PESO), Korea (KTL), USA (FM)
Ship approval	CCS, EU RO MR (DNV)
Declaration of Conformity	ATEX (EUK), China (CCC)

Safety Data

Max. voltage U_o/V_{oc}	6.5 V
---------------------------	-------

Isolator Barriers

Resistance isolator

Ex i field circuit ISpac

9180/21-77-11s Art. No. 160502



Safety Data

Max. current I_o/I_{sc}	16.5 mA				
Max. power P_o	27 mW				
Max. permissible external capacitance C_o/C_a for IIC	25 μ F				
Max. permissible external capacitance C_o/C_a for IIB	570 μ F				
Max. permissible external inductance L_o/L_a for IIC	120 mH				
Max. permissible external inductance L_o/L_a for IIB	450 mH				
Internal capacitance	Negligible				
Internal inductance	Negligible				
Safety-related max. voltage	253 V				
Intrinsically safe limiting values inductance L_o /capacitance C_o .	Jointly connectable inductance L_o /capacitance C_o .				
IIC	L_o [mH]	50 mH	5 mH	1.000 mH	0.200 mH
	C_o [μ F]	1.100 μ F	1.700 μ F	2.300 μ F	3.400 μ F
IIB	L_o [mH]	100 mH	20 mH	2 mH	0.500 mH
	C_o [μ F]	5.300 μ F			
IIA	L_o [mH]				
	C_o [μ F]				
IIIC	L_o [mH]	100.000 mH	20.000 mH	2.000 mH	0.500 mH
	C_o [μ F]	5.300 μ F	6.900 μ F	11.000 μ F	1.500 μ F

Electrical Data

Number of channels	2
LFD relay	Yes
Measuring range	180 to 3910 Ω

Auxiliary Power

Auxiliary power	24 V DC
Nominal voltage V_{nom}	24 V DC
Auxiliary power voltage range	18 to 31.2 V
Voltage range residual ripple	$\leq 3,6 V_{SS}$
Nominal current	37 mA
Power consumption	0.89 W
Max. power dissipation	0.72 W
Polarity reversal protection	Yes
Undervoltage monitoring	Yes
Operation indication	Green "PWR" LED

Galvanic Isolation

Test voltage as per standard	IEC EN 60079-11
Ex i input to output	1.5 kV AC
Ex i input to auxiliary power	1.5 kV AC
Ex i input to fault message contact	1.5 kV AC
Test voltage as per standard	EN 50178
Output to auxiliary power	350 V AC
Output to output	350 V AC

Isolator Barriers

Resistance isolator

Ex i field circuit ISpac

9180/21-77-11s Art. No. 160502



Galvanic Isolation

Fault message contact to auxiliary power	350 V AC
Fault message contact to output	350 V AC

Input

Medium resolution input	0.2 Ω
2-conductor adjustment	Via ADJ DIP switch
Sensor adjustment	DIP switch
Line fault and loss of power signalization	Contact (30 V / 100 mA) closed to ground in case of fault pac-Bus, floating contact (30 V / 100 mA)
Input for resistance temperature detector	Pt 1000
Input RTD	2-, 3- and 4-wire circuits
Sensor current RTD	200 μ A ... 0.5 mA

Output

Output signal	Equal to input signal (resistance value)
RTD connection type	2-, 3- and 4-wire circuits
Settling time output	< 10 ms
Response time output	< 1 s
Sensor current range	200 μ A ... 0.5 mA
Average measurement fault	< 0,1%
Fault message contact switching capacity	30 V / 100 mA
LF switch user adjustment	Activated/deactivated
Indication of line fault	Red "LF" LED
Wire breakage error detection	> 3940 Ω
Short circuit error detection	< 160 ohm
Behaviour of output with DB	> 10 k Ω
Behaviour of output with KS	> 10 k Ω

Ambient Conditions

Ambient temperature °C	-20 °C ... +70 °C (Single device) -20 °C ... +60 °C (Group assembly)
Ambient temperature °F	-4°F ... +158°F (Single device) -4°F ... +140°F (Group assembly)
Storage temperature °C	-40 °C ... +80 °C
Storage temperature °F	-40°F ... +176°F
Max. relative humidity	95%
Max. additional relative humidity	No condensation
Temperature influence	\leq 0,1 %/10K
Use at the height of	< 2000 m

Mechanical Data

Degree of protection (IP)	IP30
Degree of protection (IP) terminals	IP20
Fire resistance (UL 94)	V0
Enclosure material	Polyamide
AWG clamping range	16 – 12
Connection cross-section	0.2 to 2.5 mm ² flexible 0.25 to 2.5 mm ² flexible with core end sleeve 0.2 to 2.5 mm ² rigid
Grid dimension	17.6 mm

Isolator Barriers

Resistance isolator

Ex i field circuit ISpac

9180/21-77-11s Art. No. 160502



Mechanical Data

Width	17.6 mm
Width, inches	0.69 in
Height	114.5 mm
Length	108 mm
Length, inches	4.25 in
Mounting depth, inches	4.51 in
Weight	180 g
Weight	0.4 lb

Mounting / Installation

Mounting type	DIN rail NS35/15, NS35/7.5
Mounting orientation	Vertical Horizontal
Connection type	Screw terminal
Min. rigid conductor cross section	0.2 mm ²
Max. rigid conductor cross section	2.5 mm ²
Min. flex conductor cross section	0.2 mm ²
Max. flex conductor cross section	2.5 mm ²
Connection cross-section AWG	24 – 14

Technical Drawings – Subject to Alterations

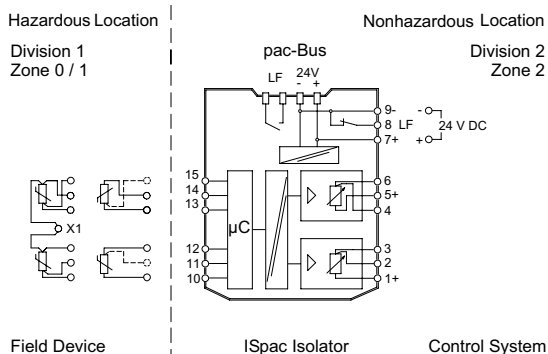

Connection diagram 9180/21-77-11

Dimensional Drawings (All Dimensions in mm [inches]) – Subject to Alterations

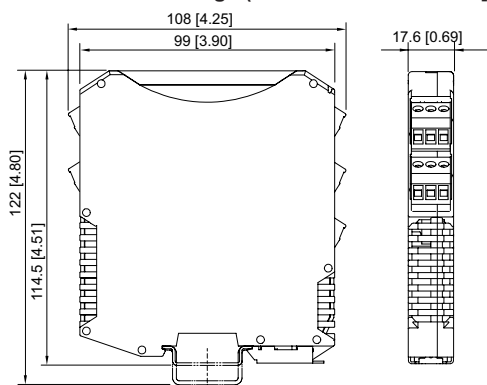

ISpac Series 9143, 9146, 9147, 9160, 9162, 9163, 9165, 9167, 9170, 9172, 9175, 9176, 9180, 9182, 9193, ISbus Series 9412 with screw terminal

Isolator Barriers

Resistance isolator

Ex i field circuit ISpac



9180/21-77-11s Art. No. 160502





Accessories

Transparent cover		Art. No.
	For 91xx ISpac modules Yellow, transparent Clear identification of the device for SIL applications. (Packaging unit: 10 pieces)	200914

Spare Parts

Screw terminal		Art. No.
	3-pole plug, screw connector thread: M3 stripping length: 7 mm color: black	112816
	3-pole plug, screw connector thread: M3 stripping length: 7 mm color: blue	112818
	3-pole plug, screw connector thread: M3 stripping length: 7 mm color: green	112817

Screw terminal with test tap		Art. No.
	3-pole plug with test tap, screw connector thread: M3 stripping length: 7 mm colour: blue	113004
	3-pole plug with test tap, screw connector thread: M3 stripping length: 7 mm colour: black	113005

We reserve the right to make alterations to the technical data, dimensions, weights, designs and products available without notice. The illustrations cannot be considered binding.