

# Isolator Barriers

Temperature transmitter

Ex i field circuit ISpac

9182/20-50-12s Art. No. 160552



- Ex i temperature transmitter, can be configured for virtually any common sensor type
- Broad range, including variants with signal conversion and trip amplifier function
- Can be used up to SIL 2 (IEC/EN 61508)

WebCode 9182A



9182 series Ex i temperature transmitters for field circuits can be used to connect temperature sensors and potentiometers. They are easy to configure for virtually any sensor type by means of software or a DIP switch. These sensor types include Pt100 sensors, thermocouples and potentiometers. Variants with a trip amplifier function allow the input signal to be analysed using two independent contacts.

## Technical Data

### Explosion Protection

Application range (Zones)	2
Ex interface zone	0 1 2 20 21 22
IECEX certificate Gas	IECEX BVS 09.0046 X
IECEX gas explosion protection	Ex nAc nCc [ia] IIC T4 Gc
IECEX dust certificate	IECEX BVS 09.0046 X
IECEX dust explosion protection	[Ex ia] IIIC
ATEX gas certificate	DMT 02 ATEX E 243 X
ATEX gas explosion protection	II 3 (1) G Ex nAc nCc [ia] IIC T4 Gc
ATEX dust certificate	DMT 02 ATEX E 243 X
ATEX dust explosion protection	II (1) D [Ex ia] IIIC
Certificate FMus	FM16US0122X
Certificate cFM	FM16CA0067X
Marking cFMus	Class I, Div. 2, Groups A,B,C,D; Class I, Zone 2, Group IIC AIS Class I,II,III, Div. 1, Groups A,B,C,D,E,F,G; Class I, Zone 0, [AEx ia]/[Ex ia] IIC T4 at Ta = 70°C See Doc. 91 826 01 31 1
Certificate cULus	E81680
EAC certificate	EAEU RU S-DE.HA91.B.00100/20
EAC certificate valid until	2025-01-26
EAC gas explosion protection	II 2 Ex nA nC [ia Ga] IIC T4 Gc X

# Isolator Barriers

Temperature transmitter

Ex i field circuit ISpac

9182/20-50-12s Art. No. 160552



## Explosion Protection

EAC dust explosion protection	Ex [Ex ia Da] IIC X
Certificates	ATEX (BVS), Brazil (ULB), Canada (FM), EAC (ENDCE), IECEx (BVS), India (PESO), Korea (KTL), Russia (Meteorological certificate), SIL (exida), USA (FM), USA (UL)
Ship approval	CCS, EU RO MR

## Safety Data

Max. voltage $U_o/V_{oc}$	6.5 V
Max. current $I_o/I_{sc}$	19.7 mA
Max. power $P_o$	32 mW
Max. permissible external capacitance $C_o/C_a$ for IIC	25 $\mu$ F
Max. permissible external capacitance $C_o/C_a$ for IIB	570 $\mu$ F
Max. permissible external inductance $L_o/L_a$ for IIC	90 mH
Max. permissible external inductance $L_o/L_a$ for IIB	330 mH
Internal capacitance $C_i$	Negligible
Internal inductance $L_i$	Negligible
Safety-related maximum voltage	253 V

## Electrical Data

Signal types	Input temperature
Number of channels	2
LFD relay	Yes
External reference junction	Pt100 2-wire connection

## Auxiliary Power

Auxiliary power	24 V DC
Nominal voltage $V_{nom}$	24 V DC
Auxiliary power voltage range	18 ... 31.2 V
Voltage range residual ripple	$\leq 3,6 V_{SS}$
Nominal current	80 mA
Power consumption	1.9 W
Power dissipation max.	1.9 W
Polarity reversal protection	Yes
Undervoltage monitoring	Yes
Operation indication	Green "PWR" LED

## Galvanic Isolation

Test voltage according to standard	IEC EN 60079-11
Galvanic isolation Ex i input to output	1.5 kV AC
Galvanic isolation Ex i input to auxiliary power	1.5 kV AC
Galvanic isolation Ex i input to fault message contact	1,5 kV AC
Test voltage according to standard 2	EN 50178
Galvanic isolation output to auxiliary power	350 V AC
Galvanic isolation output to output	350 V AC

# Isolator Barriers

Temperature transmitter

Ex i field circuit ISpac

9182/20-50-12s Art. No. 160552



## Galvanic Isolation

Galvanic isolation fault message contact to auxiliary power	350 V AC
---	----------

Galvanic isolation fault message contact to output	350 V AC
--	----------

## Input

RTD input	2-,3-,4-wire circuits
-----------	-----------------------

Sensor current	≤ 0,25 mA
----------------	-----------

2-wire compensation adjustment	via DIP switch ADJ
--------------------------------	--------------------

Sensor adjustment	via software
-------------------	--------------

Max. line resistance	≤ 1 Ω
----------------------	-------

Input for potentiometer	Up to 100 kΩs
-------------------------	---------------

Input for resistance temperature detector	See table
---	-----------

Input potentiometer	3-wire connection
---------------------	-------------------

Sensor current potentiometer	≤ 0,25 mA
------------------------------	-----------

## Output

Output	Without
--------	---------

Limit contact (per channel)	2 NO / NC
-----------------------------	-----------

Switching voltage limiting values	≤ ± 30 V
-----------------------------------	----------

Switching current limiting values	≤ 100 mA
-----------------------------------	----------

Switching state indication	LED yellow "A, B"
----------------------------	-------------------

Switching capacity fault message contact	30 V / 100 mA
--	---------------

Switch user adjustment line fault	Activated / deactivated
-----------------------------------	-------------------------

Indication of line fault	"LF" LED, red
--------------------------	---------------

Error detection wire breakage	> 1 kΩ
-------------------------------	--------

Average measurement fault	< 0,1%
---------------------------	--------

## Ambient Conditions

Ambient temperature °C	-20 °C ... +70 °C (Single device) -20 °C ... +60 °C (Group assembly)
------------------------	---

Ambient temperature °F	-4°F ... +158°F (Single device) -4°F ... +140°F (Group assembly)
------------------------	---

Storage temperature °C	-40 °C ... +80 °C
------------------------	-------------------

Storage temperature °F	-40°F ... +176°F
------------------------	------------------

Max. relative humidity	95%
------------------------	-----

Temperature influence	≤ 0,25 %/10K
-----------------------	--------------

Use at the height of	< 2000 m
----------------------	----------

## Mechanical Data

Degree of protection (IP)	IP30
---------------------------	------

Terminal degree of protection (IP)	IP20
------------------------------------	------

Fire resistance (UL 94)	V0
-------------------------	----

Connection cross-section	0.2-2.5 mm <sup>2</sup> flexible 0.2-2.5 mm <sup>2</sup> rigid 0.25-2.5 mm <sup>2</sup> flexible core end sleeve
--------------------------	--

Enclosure material	Polyamide
--------------------	-----------

Clamping range AWG	16 – 12
--------------------	---------

Connection cross-section AWG	16 ... 12
------------------------------	-----------

Grid dimension	17.6 mm
----------------	---------

# Isolator Barriers

Temperature transmitter

Ex i field circuit ISpac

9182/20-50-12s Art. No. 160552



## Mechanical Data

Width inches	0.69 in
Length inches	4.25 in
Mounting depth inches	4.51 in
Weight	0.195 kg
Weight	0.43 lb

## Mounting / Installation

Mounting type	NS35/15, NS35/7.5 DIN rail
Mounting position	Horizontal Vertical
Connection type	Screw terminal
Conductor cross-section solid min.	0.2 mm <sup>2</sup>
Conductor cross-section solid max.	2.5 mm <sup>2</sup>
Conductor cross-section flexible min.	0.2 mm <sup>2</sup>
Conductor cross-section flexible max.	2.5 mm <sup>2</sup>

## Technical Drawings – Subject to Alterations

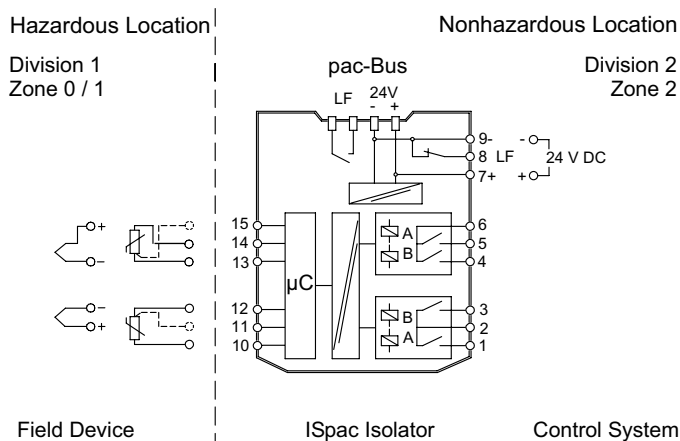

Connection diagram 9182/20-50-12

## Dimensional Drawings (All Dimensions in mm [inches]) – Subject to Alterations

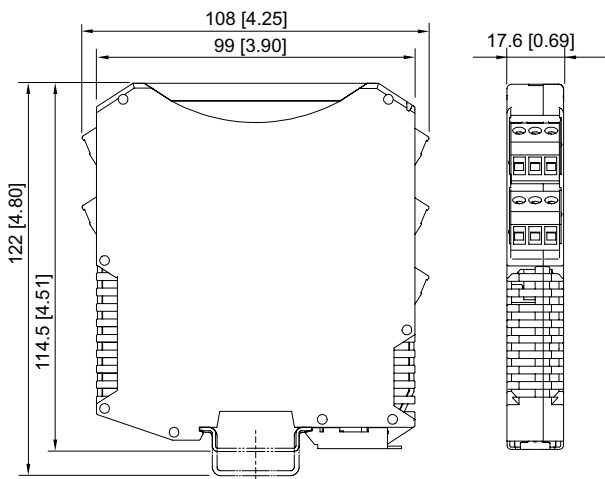

ISpac Series 9146, 9147, 9160, 9162, 9163, 9165, 9167, 9170, 9172, 9175, 9176, 9180, 9182, 9193, ISbus Series 9412 with screw terminal

# Isolator Barriers

Temperature transmitter

Ex i field circuit ISpac

9182/20-50-12s Art. No. 160552



## Accessories

### Parameterization set ISpac - Wizard

Art. No.

	<p>The software serves for commissioning, configuring and diagnosing the ISpac isolators Series 9146, 9162, 9182 and 9282. For further information, see operating instructions. Form of delivery: USB stick; parameterization software incl. parameterization cable / adaptor System requirements: IBM compatible PC with MS XP, Vista, Windows 7, 10 RS 232 C interface RS 232 / USB adaptor</p>	202595
--	---	--------



### Resistance coupling element

Art. No.

	<p>The 0/4 to 20 mA signal of channel 1 is converted to a 0/2 to 10 V signal. The resistive coupling element replaces the available connection terminal. (Set with 5 pieces)</p>	273968
--	--	--------

### External reference junction

Art. No.

	<p>External reference junction for 2 x thermocouple (1 x Pt100 for 2, 3 or 4 wire connection) integrated into the 4-pole terminal block. Installation takes place on the DIN rail.</p>	160675
	<p>External reference junction for 1 x thermocouple (Pt100 in 2 wire connection) integrated into the pluggable terminal (3-pole). Installation takes place in the ISpac device instead of the standard terminal.</p>	160676

## Spare Parts

### Screw terminal

Art. No.

	<p>3-pole plug, screw connector thread: M3 stripping length: 7 mm color: green</p>	112817
	<p>3-pole plug, screw connector thread: M3 stripping length: 7 mm color: black</p>	112816
	<p>3-pole plug, screw connector thread: M3 stripping length: 7 mm color: blue</p>	112818

### Screw terminal with test tap

Art. No.

	<p>3-pole plug with test tap, screw connector thread: M3 stripping length: 7 mm colour: black</p>	113005
--	---	--------

# Isolator Barriers

Temperature transmitter



Ex i field circuit ISpac

9182/20-50-12s Art. No. 160552



	3-pole plug with test tap, screw connector thread: M3 stripping length: 7 mm colour: blue	113004
--	--	--------

## Spring clamp terminal

		Art. No.
	3-pole plug with test tap, spring clamp connection stripping length: 10 mm color: green	112825
	3-pole plug with test tap, spring clamp connection stripping length: 10 mm color: black	112824
	3-pole plug with test tap, spring clamp connection stripping length: 10 mm color: blue	112826

We reserve the right to make alterations to the technical data, dimensions, weights, designs and products available without notice. The illustrations cannot be considered binding.