

Remote I/O

IS1+ Remote I/O Digital output module

For Zone 1 Ex i

9475/32-04-12 Art. No. 210651



- Four channels for Ex i solenoid valves up to 40 mA
- Ex ia outputs with line fault monitoring and LED error and status indication for each channel plus SIL 2 shutdown input
- Modules in Zone 1, Cl. I, II, Div. 1 can be hot swapped

MY R. STAHL 9475E



9475/32-04 series digital output modules for Zone 1, Cl. I, II, Div. 1 have four channels for actuating Ex i solenoid valves or indicator lamps. An additional Ex i control input is suitable for safe shutdown up to SIL 2. All outputs are short-circuit proof, galvanically separated from the system and individually monitored to check for wire breakage/short-circuiting.

Technical Data

Explosion Protection

Application range (Zones)	1 2
Ex interface zone	0 1 2 20 21 22
IECEX gas certificate	IECEX DEK 12.0070X
IECEX gas explosion protection	Ex ia [ia Ga] IIC T4 Gb
IECEX dust certificate	IECEX DEK 12.0070X
IECEX dust explosion protection	[Ex ia Da] IIIC
ATEX gas certificate	DEKRA 12 ATEX0232X
ATEX gas explosion protection	⊕ II 2 (1) G Ex ia [ia Ga] IIC T4 Gb
ATEX dust certificate	DEKRA 12 ATEX0232X
ATEX dust explosion protection	⊕ II (1) D [Ex ia Da] IIIC
FMus certificate	FM17US0332X
cFM certificate	FM16CA0134X
Marking cFMus	IS, Class I, Div. 1, Groups A,B,C,D; Class I, Zone 1, AEx/Ex ia [ia] IIC AIS Class I,II,III, Div. 1, Groups A,B,C,D,E,F,G; T4 at Ta = 75°C See Doc. 9475 6 031 001 1
Certificates	ATEX (DEK), Brazil (ULB), Canada (FM), China (NEPSI), IECEX (DEK), India (PESO), Korea (KTL), SIL (exida), USA (FM)
Ship approval	ABS, BVIS, EU RO MR (DNV), KR, LR
Declaration of Conformity	ATEX (EUK), China (CCC)
Installation	Zone 1, Zone 2, Cl. I, II, Div. 1, 2 and in the safe area
Further information	see respective certificate and operating instructions

Remote I/O

IS1+ Remote I/O Digital output module

For Zone 1 Ex i

9475/32-04-12 Art. No. 210651



Safety Data

Max. voltage U_o/V_{oc}	19.7 V							
Max. current I_o (Ex ia)	142 mA							
Max. power P_o (Ex ia)	698 mW							
Max. current I_o (Ex ib)	53.8 mA							
Max. power P_o (Ex ib)	617 mW							
Internal inductance	Negligible							
Max. internal capacitance C_i	11 nF (in the following tables, C_i has been subtracted from C_o)							
Max. connectable inductance L_o /capacitance C_o								
Output ia								
IIC	L_o [mH]	1.3	1.1	0.5	0.2	0.1	0.05	
	C_o [nF]	99	109	119	149	189	220	
IIB/IIIC	L_o [mH]	7.5	5.0	2.0	0.5	0.2	0.1	0.05
	C_o [nF]	669	879	889	889	989	1189	1439
Output ib								
IIC	L_o [mH]	3.1	2.0	0.6	0.5	0.2	0.1	0.05
	C_o [nF]	109	109	119	119	149	189	220
IIB/IIIC	L_o [mH]	27	20	10	5.0	0.2	0.1	0.05
	C_o [nF]	499	609	869	899	1089	1189	1439
Ex i control input "Plant STOP"								
Connection terminals	X3 1, 2 (without galvanic separation, compatible with 9575/22)						X3 3, 4 (with galvanic separation, switchable in parallel)	
Type of protection	Ex ia						Ex ia	
Max. voltage U_o	5.1 V						--	
Max. current I_o	0.44 mA						--	
Max. power P_o	0.5 mW						--	
Max. connectable inductance L_o /capacitance C_o								
IIC	L_o [mH]	100	10	2	1	0.2	0.01	--
	C_o [nF]	2.195	2.595	3.295	3.695	5.495	15.995	--
IIB/IIIC	L_o [mH]	100	10	2	1	0.2	0.01	--
	C_o [nF]	9.995	12.995	16.995	19.995	31.995		
Max. voltage U_i	--						30 V	
Max. internal resistance R_i	--						4940 Ω	

Electrical Data

Number of channels	4 Ex i outputs
Connection Ex i field signals	Pluggable, blue terminals, 16-pin, 2.5 mm ² , screw or cage clamp version with lock
Connection Ex i Steuereingang	Pluggable, blue terminals, 2-pin, 2.5 mm ² , screw type version with lock

Remote I/O

IS1+ Remote I/O Digital output module

For Zone 1 Ex i

9475/32-04-12 Art. No. 210651



Ex i X3 control input Connection terminals		X3 1, 2 (without galvanic separation, compatible with 9575/22)	X3 3, 4 (with galvanic separation, switchable in parallel)
	Supply voltage	3.3 V	--
	Internal resistance	20.5 kΩ	--
	Control voltage for all outputs "OFF" ("Plant STOP" activated)	> 2.2 V	< 1 V
	"Normal operation" ("Plant STOP" deactivated)	< 0.7 V	> 6 V

Auxiliary Power

Power supply connection	BusRail types 9494
Auxiliary power version	Intrinsically safe Ex ia via BusRail
Behaviour during undervoltage	All outputs "OFF"
Current consumption	210 mA
Max. power consumption	5 W
Max. power dissipation outputs	4 W

Galvanic Isolation

Test voltage for galvanic separation	Acc. to standard EN 60079-11
Auxiliary power/system components	≥ 1500 V AC
I/O module / I/O module	≥ 500 V AC
I/O channels/system components	≥ 500 V AC
I/O channels / ground (PA)	≥ 500 V AC
I/O channels/plant STOP X3 3,4	≥ 500 V AC
Plant STOP X3 3,4/earth (PA)	≥ 500 V AC

Input

Control input	Ex i control input X3
Control input suitability	Shutdown up to SIL 2, low demand (IEC 61508)
Control input function	"Plant STOP" for switching off all outputs

Output

Ex i output rated operation	11.3 V/40 mA
Internal resistance of outputs	170 Ω
Open-circuit voltage U_a	17.9 V

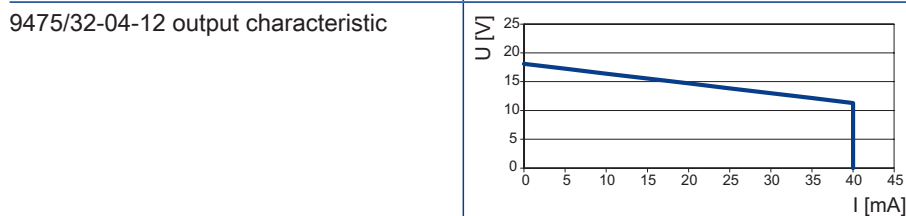

Device Specific Data

Diagnostics message module	OFF ON
Line fault monitoring	ON without test current OFF ON
Test current signal	0,2 ... 0,28 mA

Remote I/O

IS1+ Remote I/O Digital output module

For Zone 1 Ex i

9475/32-04-12 Art. No. 210651



Device Specific Data

Output behaviour in case of error	Keep last value ON OFF
LED module requires maintenance	"M/S" LED, blue
LED operating conditions	"RUN" LED, green
LED channel error	LED for each channel, red
LED channel status	LED per channel, yellow
"Plant STOP" LED	(all outputs are high-impedance) "Plant STOP" LED, yellow
Retrievable parameters	Hardware revision Manufacturer Serial number Software revision Type
Signal status bit	"1" = Output supplied with power "0" = High-impedance output
Wire breakage output	> 10 k Ω (with deactivated test current can be detected only if the output is switched on)
Short circuit output	< 30 Ω (response range 30 ... 60 Ω) (can be detected only if the output is switched on)

Diagnostics

LED group error	"ERR" LED, red
-----------------	----------------

Ambient Conditions

Ambient temperature °C	-40°C ... +75°C
Ambient temperature °F	-40°F ... +167°F
Storage temperature °C	-40°C ... +80°C
Storage temperature °F	-40°F ... +176°F
Max. operating altitude	< 2000 m
Max. relative humidity	95% (without condensation)
Shock (semi-sinusoidal)	(IEC EN 60068-2-27) 15 g (3 shocks per axis and direction)
Vibration (sinusoidal)	(IEC EN 60068-2-6) Frequency range 2 ... 13.2 Hz Amplitude 1 mm (peak value) Frequency range 13.2 ... 100 Hz Acceleration amplitude 0.7 g
Electromagnetic compatibility	Tested to the following standards and regulations: EN 61326-1 (2006) IEC 61000-4-1 to 61000-4-6, NAMUR NE 21
Note	(observe operating instructions)

Mechanical Data

Degree of protection (IP) (IEC 60529)	IP20
Module enclosure	Polyamide 6GF
Fire resistance (UL 94)	V2
Pollutant class	Corresponds to G3
Width	96.5 mm
Width, inches	3.8 in
Height	67 mm
Length	128 mm
Length, inches	5.04 in
Mounting depth, inches	2.64 in
Weight	275 g

Remote I/O

IS1+ Remote I/O Digital output module

For Zone 1 Ex i

9475/32-04-12 Art. No. 210651



Mechanical Data

Weight	0.61 lb
--------	---------

Mounting / Installation

Mounting type	on NS 35/15 DIN rail (DIN EN 60715)
Mounting orientation	Horizontal Vertical

Technical Drawings – Subject to Alterations

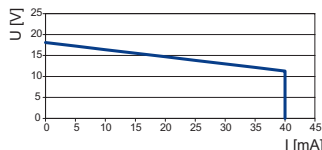

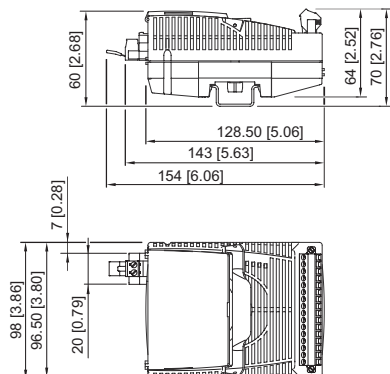

9475/32-04-12 output characteristic

Dimensional Drawings (All Dimensions in mm [inches]) – Subject to Alterations



Accessories

Pluggable terminal		Art. No.
	2.5 mm ² with lock, 16-pin, screw connector, blue, for connecting the field signals to I/O modules, for intrinsically safe field circuits Labelling: 1 to 16 Note: A second terminal is additionally required for I/O module Series 9470 and 9482 Labelling: 17 to 32	162702
	2.5 mm ² with lock, 16-pin, spring clamp connection, blue, for connecting the field signals to I/O modules, for intrinsically safe field circuits, incl. test jacks Labelling: 1 to 16 Note: A second terminal is additionally required for I/O module Series 9470 and 9482 Labelling: 17 to 32	162695
Electronic relay		Art. No.
	The 9174 electronic relay module makes it possible to switch Ex e loads using an intrinsically safe control system. Input: Ex i; output: 31.2 V/2 A DC, Ex e	212340

Remote I/O

IS1+ Remote I/O Digital output module

For Zone 1 Ex i

9475/32-04-12 Art. No. 210651



	<p>The electronic relay modules are used to switch Ex e loads using an intrinsically safe (Ex i) or non-intrinsically safe (Ex e) control system. Coil circuit: Ex i or non-Ex i (Ex e)* Contact circuit: Non-Ex i (Ex e) *It is possible to switch between Ex i and non-Ex i circuits, or vice versa, at any time without restriction.</p> <p>Note: Cannot be used with 9475/32-04-12, 9475/32-08-52, 9475/33-08-50</p>	<p>282457</p>
--	---	---------------

Ex i/Ex e relay module for Zone 1 **Art. No.**

	<p>The Ex i/Ex e relay module is used for the galvanically isolated switching of intrinsically safe (Ex i) and non-Ex i (Ex e) electrical circuits. Coil circuit: Ex i or non-Ex i (Ex e) Contact circuit: Ex i or non-Ex i (Ex e) Thanks to the integrated safeguarding for the contact and coil circuit, additional safeguarding is not necessary.</p> <p>Note: no usable with 9475/32-04-12, 9475/32-08-52, 9475/33-08-50</p>	<p>273000</p>
--	---	---------------

Partition **Art. No.**

	<p>For mounting between intrinsically safe and non-intrinsically safe connections between I/O modules to maintain a tight string length of 50 mm</p>	<p>220101</p>
---	--	---------------

Resistor error message suppression **Art. No.**

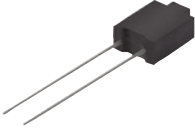
	<p>The resistors are used to suppress error messages for unused I/O channels Resistance value: 5K6/0.5 W Suitable for: AIM 9468; UMH 9469; DIOM 9470; DIOM 9471; DIOM 9472; DOM 9475 For intrinsically safe circuits (simple apparatus according to EN 60079-11)</p>	<p>244911</p>
--	---	---------------

Warning label **Art. No.**

	<p>"Clean modules only with a damp cloth."</p>	<p>162796</p>
--	--	---------------

DIN A4 sheet **Art. No.**

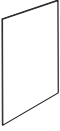
	<p>For label plate on I/O modules; 6 plates per sheet; IS Wizard printout; packaging unit = 20 sheets</p>	<p>162832</p>
--	--	---------------

Labelling strips **Art. No.**

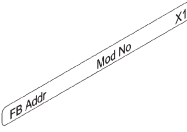
	<p>"FB Addr ... Mod No ..." for pluggable terminal, 26 pieces on the sheet</p>	<p>162788</p>
--	--	---------------

Remote I/O

IS1+ Remote I/O Digital output module

For Zone 1 Ex i

9475/32-04-12 Art. No. 210651



Vibration bracket set

Art. No.



When installed in environments with extreme vibration (> 0.7 g and max. 4 g), the 9490 vibration brackets may be used as an additional measure and provide mechanical stability for the individual modules.

For mounting: All I/O modules, except 9477/12 and 9478

Number of brackets in a set: 8

Screws (item no. 275516) must be ordered separately.

271920

Set of screws

Art. No.

Set of M5 x 14 screws (self-tapping) for 9490 vibration brackets

Number of screws in a set: 25

275516

Spare Parts

Ex i LED indicator lamp

Art. No.



8010/3-02 LED indicator lamp for intrinsically safe circuits, Ex i

237972

LED indicator lamp for front installation

Art. No.



for Ex i front installation

240901

We reserve the right to make alterations to the technical data, dimensions, weights, designs and products available without notice. The illustrations cannot be considered binding.